



KING COMERCIAL LTDA

Um nome carregado de soluções

Quick Disconnect Couplings Master Catalog



EATON

Powering Business Worldwide

Table of Contents

Safety Information	3	Special Applications	
Fluid Compatibility	4	FD14 Series	111
Pneumatic Couplings Selector Chart	67	FD17 Series	114
Fluid Transfer and Hydraulic		FD69 Series	115
HK ISO 7241-1B Series Interchange	8	FD83 Series	117
HKFR Series ISO 7241-1 BOP	17	2HKIG/2HKIL Series	118
5600 ISO 7241-1 A Series Interchange	18	ST Series	121
H5000 Series	25	Flo-Temp™ Series	125
FF Series	34	Gas-Mate™ Series	128
MLFF Series	39	Flex-Air™ Series	130
FFCup Series	41	In-Line Check Valves	132
FD96 Series	43	Diagnostic	
FD49 Series	45	FS Flow Sensor Series	133
MLDB Series	47	FD15 Series	134
5100 Series	49	FD90 Series	136
FD85 Series	53	FF14802 Pressure Gauge Kit	138
FD86 Series	55	Agriculture	
W6000 Series	57	FD48 Series	140
HP3 Series	63	FD72/76 Series	141
W56000 Series	64	Refrigerant	
FD35 Series	65	5400 Series	142
Pneumatic		Part Number Index	147
1000/400/500 Series	69		
3000/4000/5000/6000 Series	77		
Auto-Flo 23/24 Series	87		
Safeline Series	91		
180/280 Series	92		
100 Series	94		
600/700 Series	96		
2RL/3RL Series	101		
Full-Bore Series	106		
210/310 Series	108		

Eaton Quick Disconnect Couplings – Customizing Solutions for the Future... Hydraulics and Beyond

For over 90 years, Eaton has continued to manufacture and supply the highest performing quick disconnect couplings globally for many different market segments including agriculture, construction, transportation, and fire and rescue just to name a few. Eaton's quality and performance have never been compromised when it comes to engineering and manufacturing its full line of quick disconnect couplings. From traditional industry standards to custom couplings for the next generation of emerging markets and new advanced technologies, Eaton continues to provide quick disconnect coupling solutions to meet your demands.

Custom Design Capability – One Application at a Time

Eaton continues the tradition of developing custom quick disconnect couplings for customers that need a product to perform above and beyond industry standards. Whether it is a custom coupling for the world's most powerful and sophisticated super computers that use electronic cooling or a self contained breathing apparatus coupling for first responders, Eaton has the ability to work directly with you on a solution. Contact Eaton to see how our dedicated and experienced design engineering team will work with you to develop a quick disconnect coupling solution.

Safety Information for Eaton Quick Disconnect Couplings

1.0 General Instructions.

- 1.1 Scope.** The scope of this safety bulletin is to warn against improper selection, use, installation, etc. of Eaton coupling products.
- 1.2 Distribution.** A copy of this safety bulletin should be distributed to all individuals responsible for using and/or selecting Eaton coupling products.
- 1.3 Fail-Safe.** Design all systems and equipment for fail-safe operation such that failure of any component does not result in personal injury and/or property damage.
- 1.4 User Responsibility.** It is the sole responsibility of the user to select and determine that the Eaton product is compatible with the end use application. The user is responsible for reading and following this safety bulletin as well as any instructions or literature on the Eaton product being used. The user must provide necessary product warnings for Eaton couplings products, used with systems or equipment, to the operators of the systems or equipment.
- 1.5 Usage with other Manufacturers' Products.** When using Eaton coupling products with other manufacturers' adapters, hoses, etc., do not exceed the lowest pressure rating of any of the components being used or rupture may result.

2.0 Selection of Eaton Couplings.

- 2.1 Pressure.** Ensure that the maximum operating pressure of the system or equipment does not exceed the rated operating pressure of the Eaton coupling product or rupture may result.
- 2.2 Fluid Compatibility.** Verify that all components (seals, metals, etc.) are compatible with the fluid being conveyed. Failure to do so may result in high speed fluid discharge and/or leakage of fluids which may be flammable, toxic, at extreme temperatures, or otherwise harmful.
- 2.3 Temperature.** Ensure that the maximum operating temperature of the system or equipment does not exceed the rated operating temperature of the Eaton coupling product (including seals) or rupture may result.
- 2.4 Coupling Size.** Use properly sized couplings such that there is not a large pressure drop across them thus avoiding system damage due to excessive heat generation or failure of internal components.
- 2.5 Sleeve Lock.** Use sleeve locks or threaded couplings where there is the possibility of accidental disconnection. Failure to utilize sleeve locks or threaded couplings in these applications may result in hose whip, expelled components, high speed fluid discharge, system damage, or leakage of fluids which may be flammable, toxic, at extreme temperatures, or otherwise harmful.

2.6 Connect or Disconnect Under Pressure.

If connection and/or disconnection of couplings under pressure is a requirement, only use couplings designed for connection/disconnection under pressure. Failure to utilize this type of coupling in that application may result in hose whip, expelled components, high speed fluid discharge, and/or system damage. Be certain not to confuse the rated operating pressure with the rated connect/disconnect under pressure.

- 2.7 Environment.** Ensure that Eaton couplings are compatible with the surrounding environment. The surrounding environment may be heat, salt water, moisture, chemicals, and the like. Failure to protect against an adverse environment may cause system damage, premature failure, and/or leakage of fluids which may be flammable, toxic, at extreme temperatures, or otherwise harmful.
 - 2.8 External Loads.** Avoid any external loads such as side loads, tensile loads, vibration, etc. Failure to do so may result in accidental disconnection, premature failure, system damage, and/or leakage of fluids which may be flammable, toxic, at extreme temperatures, or otherwise harmful.
 - 2.9 Welding & Brazing.** Extreme heating of plated products above +450°F (+232°C) such as welding, brazing, baking, etc., where the plating is burned off, may result in the release of deadly gases.
- ## 3.0 Installation of Eaton Couplings.
- 3.1 Inspection of Product.** Prior to installation, ensure that the Eaton product meets all of the requirements of the system and/or equipment it is to be used on. Ensure you have the correct part number, function test the coupling by connecting it with a mating half. The function test should result in smooth, non-binding operation or premature failure may result.
 - 3.2 Cleanliness.** Use end caps and plugs to reduce the risk of system contamination or damage to critical sealing surfaces. Failure to do so may result in leakage of fluids which may be flammable, toxic, at extreme temperatures, or otherwise harmful. Caps and plugs are not a secondary seal unless explicitly noted.
 - 3.3 Location.** Place Eaton couplings in a safe location such as not to expose the user to personal injury (slippage, tripping, falling, etc.) during installation, connection, disconnection and maintenance.
 - 4.0 Product Maintenance.** A maintenance schedule should be put in place to ensure that Eaton couplings are functioning properly. Eaton is not responsible for product failures resulting from modification or improper maintenance.
 - 4.1 Inspection.** Visually inspect to ensure that there is no leakage, cracked components, corrosion build-up, contamination build-up, wear, etc. If any abnormality is encountered, the coupling should be replaced immediately.

Fluid Compatibility

This chart indicates the suitability of various elastomers and metals for use with fluids to be conveyed. It is intended for use with Eaton couplings and should not be used to determine compatibility for other products. It is intended as a guide only and is not a guarantee. Final selection of the proper seal or material of metal components is further dependent on many factors including pressure, fluid and ambient temperature, concentration, duration of exposure, etc.

How to Use the Chart

- Both the elastomer and the metal must be considered when determining suitability of combination for a coupling.
- Locate the fluid to be conveyed and determine the suitability of the elastomeric and metal components according to the resistance rating shown for each.
- Dimensional and operation specifications for each coupling can be found on the catalog pages.
- Information on seal options for couplings, and how to specify them, are shown in the respective sections of this catalog.
- Be sure to check the table below for maximum operating temperature range of the elastomer desired.
- For further details on the products shown in this catalog, and their applications, consult your Eaton Sales Representative or Eaton Technical Support.
- Coupling component materials may differ from body material. Refer to specific catalog pages.

Seal Elastomer Data*

Seal Elastomer**	Max. Operation Temperature Range
Buna-N	-40°F to +250°F (-40°C to +121°C)
Neoprene	-65°F to +212°F (-54°C to +100°C)
EPDM (Ethylene Propylene Rubber)	-65°F to +300°F (-54°C to +149°C)
FKM	-15°F to +400°F (-29°C to +204°C)

*For reference only, based on Eaton recommended temperatures.

**For seals not listed contact Eaton.

Contact Eaton technical support for further information.

Resistance Rating Key

E = Excellent – Fluid has little or no effect

G = Good – Fluid has minor to moderate effect

C = Conditional – Service conditions should be described to Eaton for determination of suitability for application

U = Unsatisfactory

The differences between ratings “E” and “G” are relative. Both indicate satisfactory service. Where there is a choice, the materials rated “E” may be expected to give better or longer service than those rated “G”.

Um nome carregado de soluções

This charts below are intended for reference use only. The information in this chart pertains strictly to material compatibility and is not intended to be used as an application guide.

E=Excellent
G=Good
C=Conditional
U=Unsatisfactory

Fluid	Seals				Metal			
	Buna-N	Neoprene	EPDM	FKM	Steel	Brass	Stainless Steel	Aluminum
Acetaldehyde	U	C	C	U	G	E	E	E
Acetic Acid, 10%	U	U	E	G	U	U	C	C
Acetic Acid, Glacial	U	U	C	U	U	U	C	C
Acetone	U	U	G	U	E	E	E	E
Acetophenone	U	U	E	U	E	E	E	C
Acetyl Acetone	U	U	G	U	U	C	C	C
Acetyl Chloride	U	U	U	E	C	C	C	U
Acetylene (1)	G	U	G	E	E	E	E	E
Air, Hot (Up to +160°F)	E	E	E	E	E	E	E	E
Air, Hot (161°F – 200°F)	C	G	E	E	E	E	E	E
Air, Hot (201°F – 300°F)	U	U	G	E	E	E	E	E
Air Wet, below 160°F	E	E	E	E	U	G	E	E
Aluminum Chloride, 10% aq	E	E	E	E	U	U	U	U
Aluminum Fluoride, 10% aq	E	E	E	E	U	U	U	E
Aluminum Nitrate, 10% aq	E	E	E	E	U	U	C	C

Fluid	Seals				Metal			
	Buna-N	Neoprene	EPDM	FKM	Steel	Brass	Stainless Steel	Aluminum
Aluminum Sulfate, 10% aq	E	E	E	E	U	C	E	C
Alums, 10% aq	E	E	E	E	U	C	E	C
Ammonia, Cold	E	E	E	U	E	U	E	E
Ammonia, Hot	U	G	G	U	E	U	E	E
Ammonia, Anhydrous	G	G	E	U	E	U	E	E
Ammonia, Aqueous	E	E	E	U	E	U	E	E
Ammonium Carbonate, 10% aq	U	E	E	U	C	U	C	C
Ammonium Chloride, 10% aq	E	E	E	U	U	U	C	U
Ammonium Hydroxide, 10% aq	C	C	E	C	G	U	C	C
Ammonium Nitrate, 10% aq	E	G	E	U	G	U	G	G
Ammonium Phosphate, 10% aq	E	E	E	–	U	C	G	U
Ammonium Sulfate/Sulfide, 10% aq	E	E	E	U	U	U	G	U
Amyl Acetate	U	U	G	U	E	E	E	E
Amyl Alcohol	G	C	E	G	G	G	E	U
Aniline, Aniline Oil	U	U	G	U	E	U	E	G

Fluid Compatibility

E=Excellent
G=Good
C=Conditional
U=Unsatisfactory

Fluid	Seals				Metal			
	Buna-N	Neoprene	EPDM	FKM	Steel	Brass	Stainless Steel	Aluminum
Aniline Dyes	U	G	G	G	U	C	G	C
Asphalt, < 200°F	G	C	U	E	E	G	E	C
IRM 901 Oil	E	E	C	E	E	E	E	E
IRM 902 Oil	E	G	U	E	E	E	E	E
IRM 903 Oil	E	C	U	E	E	E	E	E
Automatic Trans. Fluid	E	C	U	E	E	E	E	E
Barium Chloride, 10% aq	E	E	E	E	U	G	G	G
Barium Hydroxide, 10% aq	E	E	E	E	G	U	G	U
Barium Sulfide, 10% aq	E	E	E	E	C	U	G	U
Benzene, Benzol	U	U	U	E	G	E	E	G
Benzoic Acid	U	U	U	E	U	G	G	G
Benzyl Alcohol	U	G	G	E	E	G	E	G
BioDiesel (<B20)	G	C	U	E				
BioDiesel (>B20)	G	C	U	E				
Black Sulfate Liquor	C	C	C	E	E	C	E	U
Blast Furnace Gas	U	U	U	E	E	C	E	U
Borax, 10% aq	G	G	E	E	E	E	E	G
Boric Acid, 10% aq	G	G	G	E	U	G	C	C
Brine	E	G	E	E	U	G	G	U
Bromine, Dry	U	U	U	E	U	C	U	C
Butane	E	C	U	E	E	E	E	E
Butyl Acetate	U	U	G	U	E	E	E	E
Butyl Alcohol	E	E	G	E	G	G	G	G
Butyl Cellosolve	U	U	G	U	E	E	E	E
Butylene (Butene)	C	U	U	E	E	E	E	E
Butyl Stearate	G	U	U	E	G	G	G	G
Butyraldehyde	U	U	G	U	E	E	E	E
Calcium Acetate, 10% aq	G	G	E	U	G	G	G	C
Calcium Bisulfate, 10% aq	E	E	U	E	U	C	C	U
Calcium Chloride, 10% aq	E	E	E	E	G	G	G	C
Calcium Hydroxide, 10% aq	E	E	E	E	G	G	G	U
Calcium Hypochlorite, 10% aq	U	U	E	E	U	G	C	U
Calcium Nitrate, 10% aq	E	E	E	E	G	G	G	G
Carbitol	G	G	G	G	E	E	E	E
Carbolic Acid (Phenol)	U	U	G	E	U	E	E	-
Carbonic Acid	G	E	E	E	U	C	E	G
Carbon Dioxide, Dry Gas	G	G	E	E	E	E	E	E
Carbon Disulfide	U	U	U	E	G	G	G	E
Carbon Monoxide	G	G	E	E	E	E	E	E
Carbon Tetrachloride	U	U	U	E	U	G	G	U
Castor Oil	E	E	G	E	E	E	E	E
Cellosolve Acetate	U	U	G	U	U	U	E	G
China Wood Oil (Tung Oil)	G	G	U	E	E	G	E	E
Chlorine Gas, Dry	U	U	U	G	C	C	C	C
Chloroacetic Acid	U	U	G	U	U	U	U	U
Chloroacetone	U	U	E	U	G	G	G	U
Chlorobenzene	U	U	U	G	G	G	G	G
Chloroform	U	U	U	E	G	G	G	G
O-Chlorophenol	U	U	U	E	G	G	G	U
Chlosulfonic Acid	U	U	U	U	G	U	G	G
Chrome Plating Solution	U	U	G	E	C	U	U	U

Fluid	Seals				Metal			
	Buna-N	Neoprene	EPDM	FKM	Steel	Brass	Stainless Steel	Aluminum
Chromic Acid	U	U	C	E	C	U	U	U
Citric Acid	E	E	E	E	C	C	C	C
Coke Oven Gas	U	U	U	E	E	C	E	U
Copper Chloride, 10% aq	E	E	E	E	U	U	U	U
Copper Cyanide, 10% aq	E	E	E	E	E	U	G	U
Copper Sulfate, 10% aq	E	E	E	E	U	C	G	U
Cotton Seed Oil	E	G	C	E	E	E	E	E
Creosote (Coal Tar)	G	C	U	E	E	C	E	E
Crude Oil	E	G	U	E	G	U	G	U
Cyclohexanol	E	G	U	E	E	E	E	C
Cyclohexanone	U	U	G	U	E	E	E	C
Detergent/Water Solution	E	E	E	E	G	E	E	E
Diacetone Alcohol (Acetol)	U	U	U	E	E	E	E	E
Dibenzyl Ether	U	U	G	U	G	G	G	G
Diesel Oil	E	C	U	E	E	E	E	E
Diethylamine	G	G	G	U	E	U	E	-
Diocetyl Phthalate (DOP)	U	U	G	G	E	E	E	E
DOT #3 / #4 Brake fluid	C	U	E	U	E	C	E	E
Dowtherm A&E	U	U	U	E	G	U	E	E
Ethyl Alcohol (Ethanol)	E	E	E	E	E	E	E	G
Ethyl Acetate	U	U	G	U	E	E	E	E
Ethyl Benzene	U	U	U	E	E	G	G	G
Ethyl Cellulose	G	G	G	U	E	G	G	G
Ethyl Chloride	U	U	U	E	E	E	E	G
Ethylene Dichloride	U	U	U	G	G	C	G	G
Ethylene Glycol	E	E	E	E	U	G	E	E
Ferric Chloride, 10% aq	E	G	E	E	U	U	U	U
Ferric Nitrate, 10% aq	E	E	E	E	U	U	G	U
Ferric Sulfate, 10% aq	G	G	G	E	U	U	E	U
Formaldehyde	C	C	G	G	E	E	E	G
Formic Acid	C	G	E	U	U	C	C	C
Fuel Oil	E	C	U	E	E	E	E	E
Furfural	C	C	G	U	G	G	G	G
Gallic Acid, Solution	G	G	G	E	U	-	G	C
Gasoline	E	U	U	E	E	E	E	E
Gasohol	G	U	U	E	E	E	E	G
Glycerine/Glycerol	E	E	E	E	E	G	E	E
Green Sulfate Liquor	G	G	E	E	U	U	E	U
Helium (1)	E	E	E	E	E	E	E	E
Heptane	E	G	U	E	E	E	E	E
Hexaldehyde	U	G	G	U	G	G	E	E
Hexane	E	G	U	E	E	E	E	E
Hydraulic Oils, petroleum based	G	C	U	E	E	E	E	E
Ester Blend	E	U	U	E	E	E	E	E
Phos. Ester/Petroleum Blend	U	U	U	C	E	E	E	E
Silicone Oils	E	E	E	E	E	E	E	E
Straight Petroleum Base	E	C	U	E	E	E	E	E
Straight Phosphate Ester	U	U	G	C	E	E	E	E
Water Glycol	E	E	E	E	E	E	E	G
Water Petroleum Emulsion	E	G	U	E	C	E	E	G
Hydrobromic Acid	U	U	E	E	E	U	E	E

Fluid Compatibility

E=Excellent
G=Good
C=Conditional
U=Unsatisfactory

Fluid	Seals				Metal			
	Buna-N	Neoprene	EPDM	FKM	Steel	Brass	Stainless Steel	Aluminum
Hydrochloric Acid, Cold	U	U	G	E	U	U	U	U
Hydrocyanic Acid	C	C	E	E	E	E	G	E
Hydrofluoric Acid	U	U	C	U	U	U	U	U
Hydrofluorosilicic Acid	G	G	E	E	U	U	U	U
Hydrogen	E	E	E	E	E	E	E	E
Hydrogen Peroxide	G	G	G	E	U	U	G	E
Hydrogen Sulfide, Dry	U	G	E	U	E	G	G	G
Isocyanate	U	U	G	E	G	-	G	-
Iso Octane	E	G	U	E	E	E	E	E
Isopropyl Acetate	U	U	G	U	E	-	E	E
Isopropyl Alcohol	G	G	E	E	E	E	E	G
Isopropyl Ether	G	U	U	U	G	G	G	-
JP-4, JP-5	E	U	U	E	E	E	E	E
Kerosene	E	U	U	E	E	E	E	E
Lacquer/Lacquer Solvents	U	U	U	U	U	E	E	E
Lime Sulfur	U	E	E	E	G	U	G	-
Linseed Oil	E	G	U	E	E	E	E	E
LPG	E	G	U	E	E	E	E	E
Magnesium Chloride, 10% aq	E	E	E	E	E	C	C	G
Magnesium Hydroxide, 10% aq	G	G	E	E	E	G	E	G
Magnesium Sulfate, 10% aq	E	E	E	E	E	E	E	E
Maleic Acid	U	U	U	E	E	G	G	G
Maleic Anhydride	U	U	U	E	G	U	E	G
Malic Acid	G	G	U	G	U	-	E	G
Mercuric Chloride	E	E	E	E	U	U	U	U
Mercury	E	E	E	E	E	U	E	U
Methanol	G	G	E	U	G	G	E	C
Methyl Bromide	G	U	U	E	E	E	G	U
Methyl Chloride	U	U	U	E	E	E	E	U
Methyl Butyl Ketone	U	U	E	U	E	E	E	-
Methyl Ethyl Ketone	U	U	E	U	G	G	G	G
Methylene Chloride	U	U	U	G	G	G	G	G
Methyl Isobutyl Ketone	U	U	U	U	G	G	G	G
Methyl Isopropyl Ketone	U	U	U	U	G	G	G	G
Methyl Salicylate	U	U	C	U	E	G	G	E
MIL-L-2104	E	G	U	E	E	E	E	-
MIL-H-5606	E	G	U	E	E	E	E	E
MIL-H-6083	E	E	U	E	E	E	E	-
MIL-L-7808	G	U	U	E	G	G	E	-
MIL-L-23699	G	U	U	E	E	E	E	E
MIL-H-46170	E	G	U	E	E	E	E	-
MIL-H-83282	E	U	U	E	E	E	E	-
Mineral Oils	E	C	U	E	E	E	E	E
Naphtha	C	U	U	E	-	-	-	-
Naphthalene	U	U	U	E	E	G	E	G
Naphthenic Acid	C	U	U	E	-	G	E	G
Natural Gas	E	E	U	E	G	G	G	G
Nickel Acetate, 10% aq	C	C	E	G	G	C	E	G
Nickel Chloride, 10% aq	E	G	E	E	U	U	G	U
Nickel Sulfate, 10% aq	E	E	E	E	U	G	G	U
Nitric Acid, to 10%	U	U	U	E	U	U	E	U

Fluid	Seals				Metal			
	Buna-N	Neoprene	EPDM	FKM	Steel	Brass	Stainless Steel	Aluminum
Nitric Acid, over 10%	U	U	U	G	U	U	E	C
Nitrobenzene	U	U	U	G	E	G	E	E
Nitrogen	E	E	E	E	E	E	E	E
Octyl Alcohol	E	E	E	E	E	E	E	E
Oleic Acid	U	U	C	G	C	E	G	C
Oleum, fuming sulfuric acid	U	U	U	E	E	E	E	E
Ortho-Dichlorobenzene	U	U	U	E	G	G	G	G
Oxalic Acid, 10% aq	G	G	E	E	U	C	C	C
Oxygen	-	-	E	E	G	G	G	G
Palmitic Acid	E	G	G	E	G	-	E	G
Para-Dichlorobenzene	U	U	U	E	G	G	G	G
Pentane	E	E	U	E	G	G	G	E
Perchloric Acid	E	G	G	E	U	U	U	U
Perchloroethylene	U	U	U	E	C	G	G	G
Petroleum Base Oils	E	G	U	E	E	E	E	E
Phenol (Carbolic Acid)	U	U	G	E	U	E	E	E
Phosphate Ester	U	U	G	C	E	E	E	E
Phosphoric Acid 20%	U	U	G	E	U	E	U	C
Phosphorous Trichloride	U	U	E	E	C	U	C	E
Potassium Acetate, 10% aq	G	G	E	U	C	G	C	U
Potassium Chloride, 10% aq	E	E	E	E	E	C	E	U
Potassium Cyanide, 10% aq	E	E	E	E	C	U	G	U
Potassium Dichromate, 10% aq	E	E	E	E	C	C	C	C
Potassium Hydroxide, to 10%	G	G	E	G	G	G	G	U
Potassium Hydroxide, over 10%	C	C	E	U	G	G	G	U
Potassium Nitrate, 10% aq	E	E	E	E	G	G	E	G
Potassium Sulfate, 10% aq	E	E	E	E	-	-	-	-
Propane (Liquified)	C	G	-	E	E	E	E	E
Propyl Acetate	U	U	G	U	E	-	E	E
Propyl Alcohol	E	E	E	E	E	E	E	E
Propylene	U	U	U	E	E	E	E	E
Rapeseed oil (B100)	G	C	U	E				
Refrigerant R-12	G	E	C	E	E	E	E	E
Refrigerant R-13	G	E	C	E	E	E	E	E
Refrigerant R-22	U	E	C	U	E	E	E	E
Refrigerant R-134a	E	C	G	U	E	E	E	E
Sewage	E	E	E	E	G	G	G	G
Silicone Oils	E	E	E	E	E	E	E	E
Soap (Water Solutions)	E	E	E	E	E	E	E	U
Sodium Acetate, 10% aq	G	G	E	U	E	E	G	E
Sodium Bicarbonate, 10% aq	E	E	E	E	G	G	E	G
Sodium Borate, 10% aq	E	E	E	E	E	E	E	G
Sodium Carbonate, 10% aq	E	E	E	E	E	G	E	U
Sodium Chloride, 10% aq	E	E	E	E	U	C	C	C
Sodium Cyanide, 10% aq	E	E	E	E	E	-	C	U
Sodium Hydroxide, to 10%	U	G	E	E	C	G	C	U
Sodium Hydroxide, over 10%	U	U	G	E	C	C	C	U
Sodium Hypochlorite, 10% aq	C	C	E	C	U	U	U	U
Sodium Metaphosphate, 10% aq	E	E	E	E	E	G	G	U
Sodium Nitrate, 10% aq	G	G	E	-	E	C	E	E
Sodium Perborate, 10% aq	G	G	E	E	C	U	C	U

Fluid Compatibility

E=Excellent
G=Good
C=Conditional
U=Unsatisfactory

Fluid	Seals				Metal			
	Buna-N	Neoprene	EPDM	FKM	Steel	Brass	Stainless Steel	Aluminum
Sodium Peroxide, 10% aq	G	G	E	E	U	U	C	C
Sodium Phosphates, 10% aq	E	E	E	E	U	E	G	U
Sodium Silicate, 10% aq	E	E	E	E	E	E	E	E
Sodium Sulfate, 10% aq	E	E	E	E	C	G	G	G
Sodium Sulfide, 10% aq	E	E	E	E	C	U	C	U
Sodium Thiosulfate, 10% aq	G	E	E	E	U	U	C	G
Soy Bean Oil (B100)	E	C	U	E	E	E	E	E
Stannic Chloride	E	G	E	E	U	U	U	U
Steam (up to 388°F)	U	U	C	C	E	E	E	G
Stearic Acid	G	G	G	E	C	C	E	C
Stoddard Solvent	E	G	U	E	E	E	E	E
Styrene	U	U	U	G	E	E	E	E
Sulfur, Slurry	U	E	E	E	E	U	G	E
Sulfur Chloride, Wet	U	U	U	E	G	-	G	G
Sulfur Dioxide, Dry	U	U	G	E	E	G	G	E
Sulfur Trioxide	U	U	G	E	G	C	G	G
Sulfuric Acid, to 10%	U	G	U	E	U	G	C	-
Sulfuric Acid, over 10%	U	U	U	G	C	C	C	U
Sulfurous Acid	C	C	U	G	U	C	C	C
Tannic Acid	G	E	E	E	E	E	E	C
Tar (Bituminous)	G	U	U	E	E	G	E	E

Fluid	Seals				Metal			
	Buna-N	Neoprene	EPDM	FKM	Steel	Brass	Stainless Steel	Aluminum
Tartaric Acid	E	G	G	E	U	C	C	E
Tertiary Butyl Alcohol	G	G	G	E	G	G	G	G
Titanium Tetrachloride	C	U	U	E	E	U	G	U
Toluene (Toluol)	U	U	U	E	E	E	E	E
Trichlorethylene	U	U	U	E	E	G	E	E
Tricresyl Phosphate	U	U	E	G	E	-	C	-
Triethanolamine	E	U	E	U	E	U	E	E
Tung Oil	G	G	U	E	E	G	E	E
Turpentine	G	U	U	E	G	G	G	G
Varnish	G	U	U	E	E	G	E	E
Vinyl Chloride	U	U	U	E	E	U	C	E
Water (to +150°F)	E	E	E	E	C	G	E	G
Water (+151°F to +200°F)	E	E	E	E	C	G	E	G
Water (+201°F to +350°F)	U	U	G	G	C	G	E	G
Water Glycol	E	E	E	E	E	E	E	G
Water Petroleum Emulsion	E	G	U	E	C	E	E	G
Xylene	U	U	U	E	E	E	E	E
Zinc Chloride, 10% aq	E	E	E	E	E	U	U	C
Zinc Sulfate, 10% aq	E	E	E	E	U	C	G	C

How to build a socket or plug part number with options:

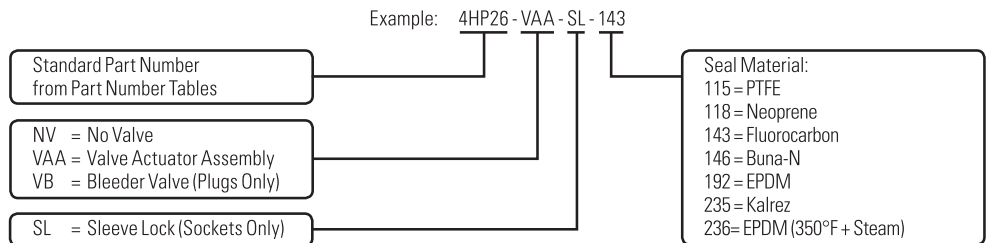

Eaton is Proud to Hold the Following Certification:

CRN CANADIAN REGISTRATION NUMBER

Eaton is CRN certified for all non-nuclear applications in all of the Canadian provinces for a select few Eaton's coupling products* Ontario Regulation 220/01 for Boilers and Pressure Vessels in Paragraph 4, states requirements for Design Registration. Eaton is the only coupling manufacturer that has achieved this registration. Our CRN is OA11599.5C and our approval is valid until 2017.

*Please contact Eaton for a list of products covered under this certification.

Seal Information for Eaton Hansen and Gromelle Products

Dash Number	Compound
-* **	Buna-N
-115	PTFE
-118	Neoprene
-143	FKM
-146**	Buna-N
-192*	EPDM
-235†	Kalrez®
-236*	EPDM

***No Dash Number required for standard seal material.

**Special for some petroleum fuels

*-192 and -236 compounds are not compatible with mineral-based greases or oils.

†Kalrez seals available by special quotation.

HK Series (Steel) ISO 7241-1 B Interchange



Eaton's HK Series coupling sets the industry standard for ISO B Couplings. The HK Series features a rugged ball latch mechanism with automatic self-sealing poppet valves in a wide array of port configurations and multiple valved and non-valved configurations.

Product Features

- Meets dimensional requirements to ISO standard 7241-1 Series B
- The coupling that sets the industry standard
- Self-sealing poppet valve design provides excellent high and low pressure sealing
- Standard seal material: Buna-N
- Seal options available in PTFE, Neoprene, FKM, EPDM, and Kalrez®
- Standard body material: Zinc trivalent plated steel with stainless steel springs, balls and retaining rings.
- PTFE back up rings in sockets (females)

Physical Characteristics

Series	Body Size	ISO Size	Nominal Flow Diameter	Max. Operating Pressure		Rated Flow*		Air Inclusion	Fluid Loss
	(in)	(mm)	(mm)	(bar)	(psi)	(lpm)	(gpm)	cc. max.	cc. max.
1HK	1/8	5	4.4	275	4,000	3	0.8	0.6	0.5
2HK	1/4	6.3	5.9	345	5,000	12	3	1.2	0.9
3HK	3/8	10	7.8	275	4,000	23	6	2.9	2.1
4HK	1/2	12.5	10	345	5,000	45	12	3.6	3.5
6HK	3/4	20	17	275	4,000	100	26	11.5	9.3
8HK	1	25	19.6	275	4,000	189	50	18.0	16.9
10HK	1 1/4**	—	26.7	118	1,700	288	76	48.0	48.0
12HK	1 1/2	40	35.1	152	2,200	375	99	91.3	91.3
20HK	2 1/2	50	46	104	1,500	757	200	209.9	209.9

* For questions related to vacuum please contact Eaton.
** No ISO Standard available for the 10HK

Applications & Markets

- Agriculture
- Hydraulic Tool
- General Industry
- Construction
- Fluid Transfer
- Transportation
- Military
- Law Enforcement/Rescue
- Chemical
- Oil and Gas
- Consumer Products
- HVAC
- Food and Beverage
- Trucks
- Aerospace
- Medical

Flow Data

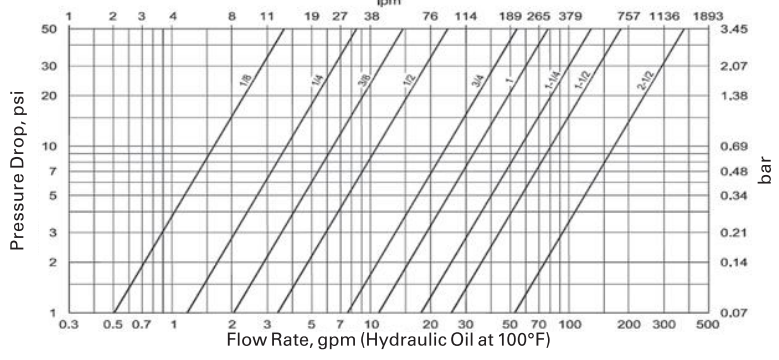

Seal Elastomer Data*

Seal Elastomer**	Max. Operation Temperature Range
Buna-N	-40°C to +121°C / 40°F to +250°F
Neoprene	-54°C to +100°C / -65°F to +212°F
EPDM (Ethylene Propylene Rubber)	-54°C to +149°C / -65°F to +300°F
FKM	-29°C to +204°C / -15°F to +400°F

* For reference only, based on Eaton recommended temperatures.
** For seals not listed contact Eaton.

Contact Eaton technical support for further information on fluid compatibility.

HK Series (Steel) ISO 7241-1 B Interchange

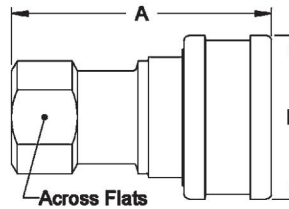

Figure 1

Sockets (Female)

Part Number HK1-8 Series	Body Size (in)	ISO Size (mm)	Thread Size (Female)			Fig.	Dimensions					
			NPTF	BSPP	SAE		A (in)	B (in)	Across Flats (in)	A (mm)	B (mm)	Across Flats (mm)
1H11	1/8	5	1/8-27	-	-	1	1.91	0.98	0.56	48.5	24.9	14.2
1H4	1/8	5	-	-	7/16-20	1	2.06	0.98	0.69	52.3	24.9	17.5
2H16	1/4	6.3	1/4-18	-	-	1	2.26	1.14	0.75	57.4	29.0	19.1
2H16BS	1/4	6.3	-	1/4-19	-	1	2.31	1.14	0.75	58.7	29.0	19.1
2H6	1/4	6.3	-	-	9/16-18	1	2.40	1.14	0.88	61.0	29.0	22.4
3H21	3/8	10	3/8-18	-	-	1	2.56	1.42	0.88	65.0	36.1	22.4
3H21BS	3/8	10	-	3/8-19	-	1	2.56	1.42	0.88	65.0	36.1	22.4
3H8	3/8	10	-	-	3/4-16	1	2.74	1.42	1.00	69.6	36.1	25.4
4HP26	1/2	12.5	1/2-14	-	-	1	2.96	1.86	1.13	75.2	47.2	28.7
4HP26BS	1/2	12.5	-	1/2-14	-	1	2.96	1.86	1.13	75.2	47.2	28.7
4HP10	1/2	12.5	-	-	7/8-14	1	3.05	1.86	1.25	77.5	47.2	31.8
6HP31	3/4	20	3/4-14	-	-	1	3.48	2.22	1.31	88.4	56.4	33.3
6HP31BS	3/4	20	-	3/4-14	-	1	3.48	2.22	1.31	88.4	56.4	33.3
6HP12	3/4	20	-	-	1 1/16-12	1	3.67	2.22	1.38	93.2	56.4	35.1
8HP36	1	25	1-11 1/2	-	-	1	4.13	2.61	1.75	104.9	66.3	44.5
8HP36BS	1	25	-	1-11	-	1	4.13	2.61	1.75	104.9	66.3	44.5
8HP16	1	25	-	-	1 1/16-12	1	4.13	2.61	1.88	104.9	66.3	47.8

A=Overall Length, B=Maximum Diameter
To obtain connected length of coupling, add dimensions A (Fig. 1) and E (Fig. 3) together.

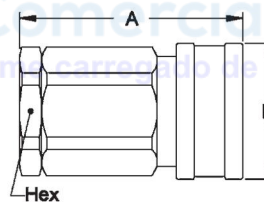

Figure 2

Sockets (Female)

Part Number HK10/12/20 Series	Body Size (in)	ISO Size (mm)	Thread Size (Female)		Fig.	Dimensions					
			NPTF	BSPP		A (in)	B (in)	Hex (in)	A (mm)	B (mm)	Hex (mm)
10H41*	1 1/4	-	1 1/4-11 1/2	-	2	4.51	2.73	2.38	114.6	69.3	60.5
10H41BS*	1 1/4	-	-	1 1/4-11	2	4.51	2.73	2.38	114.6	69.3	60.5
12H41	1 1/2	40	1 1/4-11 1/2	-	2	4.82	3.23	2.38	122.4	82.0	60.5
12H41BS	1 1/2	40	-	1 1/4-11	2	4.82	3.23	2.38	122.4	82.0	60.5
12H46	1 1/2	40	1 1/2-11 1/2	-	2	4.82	3.23	2.38	122.4	82.0	60.5
12H46BS	1 1/2	40	-	1 1/2-11	2	4.82	3.23	2.38	122.4	82.0	60.5
20H51	2 1/2	50	2-11 1/2	-	2	5.55	4.11	3.75	141.0	104.4	95.3
20H51BS	2 1/2	50	-	2-11	2	5.55	4.11	3.75	141.0	104.4	95.3
20H56	2 1/2	50	2 1/2-8	-	2	6.14	4.11	3.75	156.0	104.4	95.3
20H56BS	2 1/2	50	-	2 1/2-11	2	6.14	4.11	3.75	156.0	104.4	95.3
20H61	2 1/2	50	3-8	-	2	7.00	4.11	4.00	177.8	104.4	101.6
20H61BS	2 1/2	50	-	3-11	2	7.00	4.11	4.00	177.8	104.4	101.6

A=Overall Length, B=Maximum Diameter
* ISO 7241-1 Series B does not include 1-1/4 inch body size couplings; therefore, Series 10HK is not covered by this standard
To obtain connected length of coupling, add dimensions A (Fig. 2) and E (Fig. 4) together.

FLUID TRANSFER
AND HYDRAULIC

PNEUMATIC

SPECIAL APPLICATIONS

DIAGNOSTIC

AGRICULTURE

REFRIGERANT

HK Series (Steel) ISO 7241-1 B Interchange

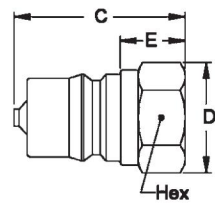

Figure 3

Plugs (Male)

Part Number HK1-8 Series	Body Size (in)	ISO Size (mm)	Thread Size (Female)			Fig.	Dimensions							
			NPTF	BSPP	SAE		C (in)	D (in)	E (in)	Hex (in)	C (mm)	D (mm)	E (mm)	Hex (mm)
1K11	1/8	5	1/8-27	-	-	3	1.26	0.65	0.44	0.56	32.0	16.5	11.2	14.2
1K4	1/8	5	-	-	7/16-20	3	1.41	0.79	0.59	0.69	35.8	20.1	15.0	17.5
2K16	1/4	6.3	1/4-18	-	-	3	1.52	0.87	0.56	0.75	38.6	22.1	14.2	19.1
2K16BS	1/4	6.3	-	1/4-19	-	3	1.52	0.87	0.56	0.75	38.6	22.1	14.2	19.1
2K6	1/4	6.3	-	-	9/16-18	3	1.66	1.01	0.70	0.88	42.2	25.7	17.8	22.4
3K21	3/8	10	3/8-18	-	-	3	1.76	1.01	0.61	0.88	44.7	25.7	15.5	22.4
3K21BS	3/8	10	-	3/8-19	-	3	1.76	1.01	0.61	0.88	44.7	25.7	15.5	22.4
3K8	3/8	10	-	-	3/4-16	3	1.94	1.15	0.79	1.00	49.3	29.2	20.1	25.4
4KP26	1/2	12.5	1/2-14	-	-	3	2.03	1.30	0.76	1.13	51.6	33.0	19.3	28.7
4KP26BS	1/2	12.5	-	1/2-14	-	3	2.03	1.30	0.76	1.13	51.6	33.0	19.3	28.7
4KP10	1/2	12.5	-	-	7/8-14	3	2.11	1.37	0.84	1.19	53.6	34.8	21.3	30.2
6KP31	3/4	20	3/4-14	-	-	3	2.36	1.52	0.71	1.31	59.9	38.6	18.0	33.3
6KP31BS	3/4	20	-	3/4-14	-	3	2.36	1.52	0.71	1.31	59.9	38.6	18.0	33.3
6KP12	3/4	20	-	-	1 1/16-12	3	2.54	1.59	0.89	1.38	64.5	40.4	22.6	35.1
8KP36	1	25	1-11 1/2	-	-	3	2.85	1.88	0.97	1.63	72.4	47.8	24.6	41.4
8KP36BS	1	25	-	1-11	-	3	2.85	1.88	0.97	1.63	72.4	47.8	24.6	41.4
8KP16	1	25	-	-	1 1/8-12	3	2.85	2.17	0.97	1.88	72.4	55.1	24.6	47.8

C=Overall Length, D=Maximum Diameter, E=Exposed Length when Connected
To obtain connected length of coupling, add dimensions A (Fig. 1) and E (Fig. 3) together.

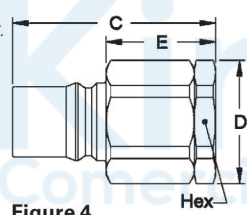

Figure 4

Plugs (Male)

Part Number HK10/12/20 Series	Body Size (in)	ISO Size (mm)	Thread Size (Female)		Fig.	Dimensions							
			NPTF	BSPP		C (in)	D (in)	E (in)	Hex (in)	C (mm)	D (mm)	E (mm)	Hex (mm)
10K41*	1 1/4	-	1 1/4-11 1/2	-	4	4.25	2.74	2.33	2.38	108.0	69.6	59.2	60.5
10K41BS*	1 1/4	-	-	1 1/4-11	4	4.25	2.74	2.33	2.38	108.0	69.6	59.2	60.5
12K41	1 1/2	40	1 1/4-11 1/2	-	4	4.76	2.74	2.67	2.38	120.9	69.6	67.8	60.5
12K41BS	1 1/2	40	-	1 1/4-11	4	4.76	2.74	2.67	2.38	120.9	69.6	67.8	60.5
12K46	1 1/2	40	1 1/2-11 1/2	-	4	4.76	2.74	2.67	2.38	120.9	69.6	67.8	60.5
12K46BS	1 1/2	40	-	1 1/2-11	4	4.76	2.74	2.67	2.38	120.9	69.6	67.8	60.5
20K51	2 1/2	60	2-11 1/2	-	4	5.49	4.33	2.97	3.75	139.4	110.0	75.4	95.3
20K51BS	2 1/2	60	-	2-11	4	5.49	4.33	2.97	3.75	139.4	110.0	75.4	95.3
20K56	2 1/2	60	2 1/2-8	-	4	6.08	4.33	3.56	3.75	154.4	110.0	90.4	95.3
20K56BS	2 1/2	60	-	2 1/2-11	4	6.08	4.33	3.56	3.75	154.4	110.0	90.4	95.3
20K61	2 1/2	60	3-8	-	4	6.94	4.62	4.42	4.00	176.3	117.3	112.3	101.6
20K61BS	2 1/2	60	-	3-11	4	6.94	4.62	4.42	4.00	176.3	117.3	112.3	101.6

C=Overall Length, D=Maximum Diameter, E=Exposed Length when Connected
* ISO 7241-1 Series B does not include 1-1/4 inch body size couplings; therefore, 1 1/4 10HK is not covered by this standard
To obtain connected length of coupling, add dimensions A (Fig. 2) and E (Fig. 4) together.

Dust Plugs and Dust Caps Accessories

Coupling Series	Plug Dust Cap Part No.		Socket Dust Plug Part No.	
	Metal	Vinyl	Metal	Vinyl
1HK	PDC1HK*	PPDC1HK	SDC1HK*	PSDC1HK
2HK	PDC2HK*	PPDC2HK	SDC2HK*	PSDC2HK
3HK	PDC3HK*	PPDC3HK	SDC3HK*	PSDC3HK
4HK	PDC4HK**	PPDC4HK(RD)***	SDC4HK**	PSDC4HK(RD)***
6HK	PDC6HK**	PPDC6HK(RD)***	SDC6HK**	PSDC6HK(RD)***
8HK	PDC8HK**	PPDC8HK(RD)***	SDC8HK**	PSDC8HK(RD)***
12HK	PDC12HK*		SDC12HK*	
20HK	PDC20HK*		SDC20HK*	

*Brass **Aluminum ***Offered in red by adding RD to end of part number



HK Series (Brass) ISO 7241-1 B Interchange



Eaton's HK brass is a general purpose industrial interchange coupling available in valved or non-valved designs, offered in brass for excellent corrosion resistance in rugged applications where stainless steel is unacceptable. The HK Series features a ball latch mechanism with automatic self-sealing poppet valves.

Product Features

- Meets dimensional requirements to ISO standard 7241-1 Series B
- Brass construction with stainless steel springs for greater corrosion resistance and fluid compatibility
- Self-sealing poppet valves provide excellent high and low pressure sealing
- Standard seal material: Buna-N
- Seal options available in PTFE, Neoprene, FKM, EPDM, and Kalrez®

Physical Characteristics

Series	Body Size (in)	ISO Size (mm)	Nominal Flow Diameter (mm)	Max. Operating Pressure (bar)	Max. Operating Pressure (psi)	Rated Flow (lpm)	Rated Flow (gpm)	Air Inclusion cc. max.	Fluid Loss cc. max.
1HK	1/8	5	4.4	207	3,000	3	0.8	0.6	0.5
2HK	1/4	6.3	5.9	186	2,700	12	3	1.2	0.9
3HK	3/8	10	7.8	152	2,200	23	6	2.9	2.1
4HK	1/2	12.5	10	155	2,250	45	12	3.6	3.5
6HK	3/4	20	17	138	2,000	100	26	11.5	9.3
8HK	1	25	19.6	103	1,500	189	50	18.0	16.9
10HK	1 1/4**	-	26.7	83	1,200	288	76	48.0	48.0
12HK	1 1/2	40	35.1	104	1,500	375	99	91.3	91.3
20HK	2 1/2	50	46	49	700	757	200	209.9	209.9

*For questions related to vacuum please contact Eaton.

** No ISO Standard available for the 10HK

Applications & Markets

- Agriculture
- Hydraulic Tool
- General Industry
- Construction
- Fluid Transfer
- Chemical
- Oil and Gas
- Transportation
- Food and Beverage
- Trucks
- Nuclear

Flow Data

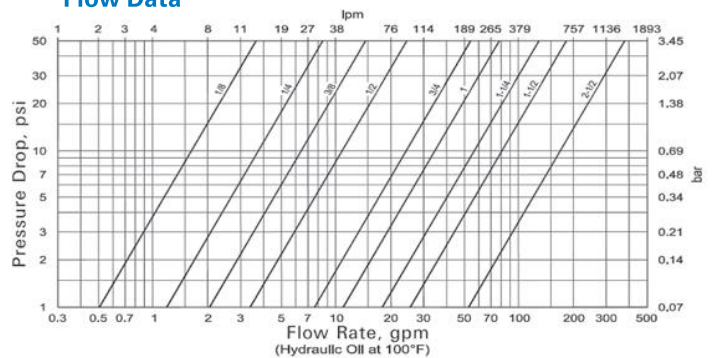

Seal Elastomer Data*

Seal Elastomer	Max. Operation Temperature Range
Buna-N	-40°C to +121°C/40°F to +250°F
Neoprene	-54°C to +100°C/-65°F to +212°F
EPDM (Ethylene Propylene Rubber)	-54°C to +149°C/-65°C to +300°F
FKM	-29°C to +204°C/-15°F to +400°F

*For reference only, based on Eaton recommended temperatures.

Contact Eaton technical support for further information on fluid compatibility.

HK Series (Brass) ISO 7241-1 B Interchange

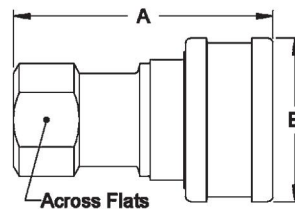

Figure 1

Sockets (Female)

Part Number HK1-8 Series	Body Size (in)	ISO Size (mm)	Thread Size (Female)		Fig.	Dimensions					
			NPTF	BSPP		A (in)	B (in)	Across Flats (in)	A (mm)	B (mm)	Across Flats (mm)
B1H11	1/8	5	1/8-27	-	1	1.91	0.98	0.56	48.5	24.9	14.2
B2H16	1/4	6.3	1/4-18	-	1	2.26	1.14	0.75	57.4	29.0	19.1
B2H16BS	1/4	6.3	-	1/4-19	1	2.31	1.14	0.75	58.7	29.0	19.1
B3H21	3/8	10	3/8-18	-	1	2.56	1.42	0.88	65.0	36.1	22.4
B3H21BS	3/8	10	-	3/8-19	1	2.56	1.42	0.88	65.0	36.1	22.4
B4HP26	1/2	12.5	1/2-14	-	1	2.96	1.86	1.13	75.2	47.2	28.7
B4HP26BS	1/2	12.5	-	1/2-14	1	2.96	1.86	1.13	75.2	47.2	28.7
B6HP31	3/4	20	3/4-14	-	1	3.48	2.22	1.31	88.4	56.4	33.3
B6HP31BS	3/4	20	-	3/4-14	1	3.48	2.22	1.31	88.4	56.4	33.3
B8HP36	1	25	1-11 1/2	-	1	4.13	2.61	1.75	104.9	66.3	44.5
B8HP36BS	1	25	-	1-11	1	4.13	2.61	1.75	104.9	66.3	44.5

A=Overall Length, B=Maximum Diameter

To obtain connected length of coupling, add dimensions A (Fig. 1) and E (Fig. 3) together.

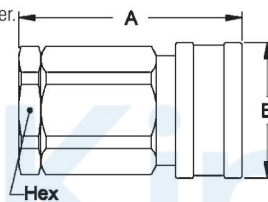

Figure 2

Sockets (Female)

Part Number HK10/12/20 Series	Body Size (in)	ISO Size (mm)	Thread Size (Female)		Fig.	Dimensions					
			NPTF	BSPP		A (in)	B (in)	Hex (in)	A (mm)	B (mm)	Hex (mm)
B10H41*	1 1/4	-	1 1/4-11 1/2	-	2	4.51	2.73	2.38	114.6	69.3	60.5
B12H41	1 1/2	40	1 1/4-11 1/2	-	2	4.82	3.23	2.38	122.4	82.0	60.5
B12H41BS	1 1/2	40	-	1 1/4-11	2	4.82	3.23	2.38	122.4	82.0	60.5
B12H46	1 1/2	40	1 1/2-11	-	2	4.82	3.23	2.38	122.4	82.0	60.5
B12H46BS	1 1/2	40	-	1 1/2-11	2	4.82	3.23	2.38	122.4	82.0	60.5
B20H51	2 1/2	50	2-11 1/2	-	2	5.55	4.11	3.75	141.0	104.4	95.3
B20H51BS	2 1/2	50	-	2-11	2	5.55	4.11	3.75	141.0	104.4	95.3
B20H56	2 1/2	50	2 1/2-8	-	2	6.14	4.11	3.75	156.0	104.4	95.3
B20H56BS	2 1/2	50	-	2 1/2-11	2	6.14	4.11	3.75	156.0	104.4	95.3
B20H61	2 1/2	50	3-8	-	2	7.00	4.11	4.00	177.8	104.4	101.6
B20H61BS	2 1/2	50	-	3-11	2	7.00	4.11	4.00	177.8	104.4	101.6

A=Overall Length, B=Maximum Diameter

* ISO 7241-1 Series B does not include 1-1/4 inch body size couplings; therefore, Series 10HK is not covered by this standard

To obtain connected length of coupling, add dimensions A (Fig. 2) and E (Fig. 4) together.



HK Series (Brass) ISO 7241-1 B Interchange

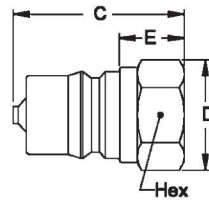

Figure 3

Plugs (Male)

Part Number HK1-8 Series	Body Size		Thread Size (Female)		Fig.	Dimensions							
	(in)	(mm)	NPTF	BSPP		C (in)	D (in)	E (in)	Hex (in)	C (mm)	D (mm)	E (mm)	Hex (mm)
B1K11	1/8	5	1/8-27	-	3	1.26	0.65	0.44	0.56	32.0	16.5	11.2	14.2
B2K16	1/4	6.3	1/4-18	-	3	1.52	0.87	0.56	0.75	38.6	22.1	14.2	19.1
B2K16BS	1/4	6.3	-	1/4-19	3	1.52	0.87	0.56	0.75	38.6	22.1	14.2	19.1
B3K21	3/8	10	3/8-18	-	3	1.76	1.01	0.61	0.88	44.7	25.7	15.5	22.4
B3K21BS	3/8	10	-	3/8-19	3	1.76	1.01	0.61	0.88	44.7	25.7	15.5	22.4
B4K26	1/2	12.5	1/2-14	-	3	2.03	1.30	0.76	1.13	51.6	33.0	19.3	28.7
B4K26BS	1/2	12.5	-	1/2-14	3	2.03	1.30	0.76	1.13	51.6	33.0	19.3	28.7
B6K31	3/4	20	3/4-14	-	3	2.36	1.52	0.71	1.31	59.9	38.6	18.0	33.3
B6K31BS	3/4	20	-	3/4-14	3	2.36	1.52	0.71	1.31	59.9	38.6	18.0	33.3
B8K36	1	25	1-11 1/2	-	3	2.85	1.88	0.97	1.63	72.4	47.8	24.6	41.4
B8K36BS	1	25	-	1-11	3	2.85	1.88	0.97	1.63	72.4	47.8	24.6	41.4

C=Overall Length, D=Maximum Diameter, E=Exposed Length when Connected
To obtain connected length of coupling, add dimensions A (Fig. 1) and E (Fig. 3) together.

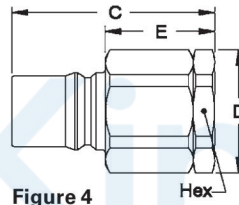

Figure 4

Plugs (Male)

Part Number HK10/12/20 Series	Body Size		Thread Size (Female)		Fig.	Dimensions							
	(in)	(mm)	NPTF	BSPP		C (in)	D (in)	E (in)	Hex (in)	C (mm)	D (mm)	E (mm)	Hex (mm)
B10K41*	1 1/4	-	1 1/4-11 1/2	-	4	4.25	2.74	2.33	2.38	108.0	69.6	59.2	60.5
B12K41	1 1/2	40	1 1/4-11 1/2	-	4	4.76	2.74	2.67	2.38	120.9	69.6	67.8	60.5
B12K41BS	1 1/2	40	-	1 1/4-11	4	4.76	2.74	2.67	2.38	120.9	69.6	67.8	60.5
B12K46	1 1/2	40	1 1/2-11 1/2	-	4	4.76	2.74	2.67	2.38	120.9	69.6	67.8	60.5
B12K46BS	1 1/2	40	-	1 1/2-11	4	4.76	2.74	2.67	2.38	120.9	69.6	67.8	60.5
B20K51	2 1/2	50	2-11 1/2	-	4	5.49	4.33	2.97	3.75	139.4	110.0	75.4	95.3
B20K51BS	2 1/2	50	-	2-11	4	5.49	4.33	2.97	3.75	139.4	110.0	75.4	95.3
B20K56	2 1/2	50	2 1/2-8	-	4	6.08	4.33	3.56	3.75	154.4	110.0	90.4	95.3
B20K56BS	2 1/2	50	-	2 1/2-11	4	6.08	4.33	3.56	3.75	154.4	110.0	90.4	95.3
B20K61	2 1/2	50	3-8	-	4	6.94	4.62	4.42	4.00	176.3	117.3	112.3	101.6
B20K61BS	2 1/2	50	-	3-11	4	6.94	4.62	4.42	4.00	176.3	117.3	112.3	101.6

C=Overall Length, D=Maximum Diameter, E=Exposed Length when Connected
* ISO 7241-1 Series B does not include 1-1/4 inch body size couplings; therefore, Series 10HK is not covered by this standard
To obtain connected length of coupling, add dimensions A (Fig. 2) and E (Fig. 4) together.

Dust Plugs and Dust Caps Accessories

Coupling Series	Plug Dust Cap Part No.		Socket Dust Plug Part No.	
	Metal	Vinyl	Metal	Vinyl
1HK	PDC1HK*	PPDC1HK	SDC1HK*	PSDC1HK
2HK	PDC2HK*	PPDC2HK	SDC2HK*	PSDC2HK
3HK	PDC3HK*	PPDC3HK	SDC3HK*	PSDC3HK
4HK	PDC4HK**	PPDC4HK(RD)***	SDC4HK**	PSDC4HK(RD)***
6HK	PDC6HK**	PPDC6HK(RD)***	SDC6HK**	PSDC6HK(RD)***
8HK	PDC8HK**	PPDC8HK(RD)***	SDC8HK**	PSDC8HK(RD)***
12HK	PDC12HK*		SDC12HK*	
20HK	PDC20HK*		SDC20HK*	

*Brass **Aluminum ***Offered in red by adding RD to end of part number



HK Series Series (Stainless Steel) ISO 7241-1 B Interchange



Eaton's HK Series stainless steel is a general purpose industrial interchange coupling available in valved or non-valved designs, offered in 303/316 grades of stainless steel for excellent corrosion resistance in rugged applications. The HK Series features a ball latch mechanism with automatic self-sealing poppet valves.

Product Features

- Meets dimensional requirements to ISO standard 7241-1 Series B
- 303/316 Stainless steel construction for greater corrosion resistance and fluid compatibility
- Self-sealing poppet valves provide excellent high and low pressure sealing
- Standard body material: 303 or 316 Stainless Steel
- Standard seal material: Buna-N
- Seal options available in PTFE, Neoprene, FKM, EPDM, and Kalrez®

Physical Characteristics

Series	Body Size	ISO Size	Nominal Flow Diameter	Max. Operating Pressure		Rated Flow		Air Inclusion	Fluid Loss
	(in)	(mm)	(mm)	(bar)	(psi)	(lpm)	(gpm)	cc. max.	cc. max.
1HK	1/8	5	4.4	344	5,000	3	0.8	0.6	0.5
2HK	1/4	6.3	5.9	255	3,700	12	3	1.2	0.9
3HK	3/8	10	7.8	255	3,700	23	6	2.9	2.1
4HK	1/2	12.5	10	293	4,250	45	12	3.6	3.5
6HK	3/4	20	17	242	3,500	100	26	11.5	9.3
8HK	1	25	19.6	207	3,000	189	50	18.0	16.9
10HK	1 1/4**	-	26.7	118	1,700	288	76	48.0	48.0
12HK	1 1/2	40	35.1	152	2,200	375	99	91.3	91.3
20HK	2 1/2	50	46	104	1,500	757	200	209.9	209.9

* For questions related to vacuum please contact Eaton.

** No ISO Standard available for the 10HK

Applications & Markets

- Agriculture
- Hydraulic Tool
- General Industry
- Construction
- Fluid Transfer
- Transportation
- Military
- Law Enforcement/Rescue
- Chemical
- Oil and Gas
- Consumer Products
- HVAC
- Food and Beverage
- Trucks
- Aerospace
- Medical

Flow Data

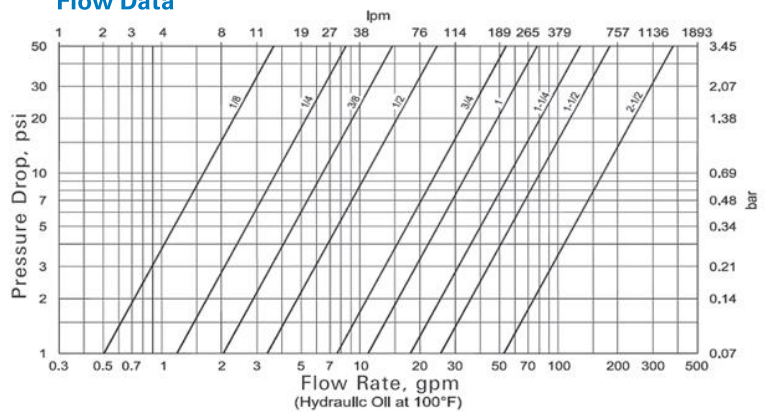

Seal Elastomer Data*

Seal Elastomer	Max. Operation Temperature Range
Buna-N	-40°C to +121°C / 40°F to +250°F
Neoprene	-54°C to +100°C / -65°F to +212°F
EPDM (Ethylene Propylene Rubber)	-54°C to +149°C / -65°C to +300°F
FKM	-29°C to +204°C / -15°F to +400°F

* For reference only, based on Eaton recommended temperatures.

Contact Eaton technical support for further information on fluid compatibility.

HK Series Series (Stainless Steel) ISO 7241-1 B Interchange

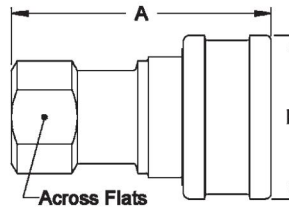

Figure 1

Sockets (Female)

Part Number HK1-8 Series 303 Stainless Steel	316 Stainless Steel	Body Size (in)	ISO Size (in)	Thread Size (Female)			Fig.	Dimensions					
				NPTF	BSPP	SAE		A (in)	B (in)	Across Flats (in)	A (mm)	B (mm)	Across Flats (mm)
LL1H11	ML1H11	1/8	5	1/8-27	-	-	1	1.91	0.98	0.56	48.5	24.9	14.2
LL1H4	-	1/8	5	-	-	7/16-20	1	2.06	0.98	0.69	52.3	24.9	17.5
LL2H16	ML2H16	1/4	6.3	1/4-18	-	-	1	2.26	1.14	0.75	57.4	29.0	19.1
LL2H16BS	ML2H16BS	1/4	6.3	-	1/4-19	-	1	2.31	1.14	0.75	58.7	29.0	19.1
LL2H6	-	1/4	6.3	-	-	9/16-18	1	2.40	1.14	0.88	61.0	29.0	22.4
LL3H21	ML3H21	3/8	10	3/8-18	-	-	1	2.56	1.42	0.88	65.0	36.1	22.4
LL3H21BS	ML3H21BS	3/8	10	-	3/8-19	-	1	2.56	1.42	0.88	65.0	36.1	22.4
LL3H8	-	3/8	10	-	-	3/4-16	1	2.74	1.42	1.00	69.6	36.1	25.4
LL4HP26	ML4HP26	1/2	12.5	1/2-14	-	-	1	2.96	1.86	1.13	75.2	47.2	28.7
LL4HP26BS	ML4HP26BS	1/2	12.5	-	1/2-14	-	1	2.96	1.86	1.13	75.2	47.2	28.7
LL4HP10	-	1/2	12.5	-	-	7/8-14	1	3.05	1.86	1.25	77.5	47.2	31.8
LL6HP31	ML6HP31	3/4	20	3/4-14	-	-	1	3.48	2.22	1.31	88.4	56.4	33.3
LL6HP31BS	ML6HP31BS	3/4	20	-	3/4-14	-	1	3.48	2.22	1.31	88.4	56.4	33.3
LL6HP12	-	3/4	20	-	-	1 1/8-12	1	3.67	2.22	1.38	93.2	56.4	35.1
LL8HP36	ML8HP36	1	25	1-11 1/2	-	-	1	4.13	2.61	1.75	104.9	66.3	44.5
LL8HP36BS	ML8HP36BS	1	25	-	1-11	-	1	4.13	2.61	1.75	104.9	66.3	44.5
LL8HP16	-	1	25	-	-	1 1/8-12	1	4.13	2.61	1.88	104.9	66.3	47.8

A=Overall Length, B=Maximum Diameter

To obtain connected length of coupling, add dimensions A (Fig. 1) and E (Fig. 3) together.

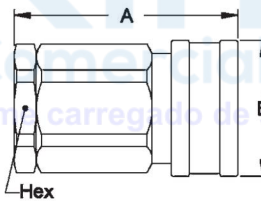

Figure 2

Sockets (Female)

Part Number HK10/12/20 Series 303 Stainless Steel	Body Size (in)	ISO Size (mm)	Thread Size (Female)		Fig.	Dimensions					
			NPTF	BSPP		A (in)	B (in)	Hex (in)	A (mm)	B (mm)	Hex (mm)
LL10H41*	1 1/4	-	1 1/4-11 1/2	-	2	4.51	2.73	2.38	114.6	69.3	60.5
LL10H41BS*	1 1/4	-	-	1 1/4-11	2	4.51	2.73	2.38	114.6	69.3	60.5
LL12H41	1 1/2	40	1 1/4-11 1/2	-	2	4.82	3.23	2.38	122.4	82.0	60.5
LL12H41BS	1 1/2	40	-	1 1/4-11	2	4.82	3.23	2.38	122.4	82.0	60.5
LL12H46	1 1/2	40	1 1/2-11 1/2	-	2	4.82	3.23	2.38	122.4	82.0	60.5
LL12H46BS	1 1/2	40	-	1 1/2-11	2	4.82	3.23	2.38	122.4	82.0	60.5
LL20H51	2 1/2	50	2-11 1/2	-	2	5.55	4.11	3.75	141.0	104.4	95.3
LL20H51BS	2 1/2	50	-	2-11	2	5.55	4.11	3.75	141.0	104.4	95.3
LL20H56	2 1/2	50	2 1/2-8	-	2	6.14	4.11	3.75	156.0	104.4	95.3
LL20H56BS	2 1/2	50	-	2 1/2-11	2	6.14	4.11	3.75	156.0	104.4	95.3
LL20H61	2 1/2	50	3-8	-	2	7.00	4.11	4.00	177.8	104.4	101.6
LL20H61BS	2 1/2	50	-	3-11	2	7.00	4.11	4.00	177.8	104.4	101.6

A=Overall Length, B=Maximum Diameter

* ISO 7241-1 Series B does not include 1-1/4 inch body size couplings; therefore, Series 10HK is not covered by this standard.

To obtain connected length of coupling, add dimensions A (Fig. 2) and E (Fig. 4) together.

FLUID TRANSFER
AND HYDRAULIC

PNEUMATIC

SPECIAL APPLICATIONS

DIAGNOSTIC

AGRICULTURE

REFRIGERANT

HK Series (Stainless Steel) ISO 7241-1 B Interchange

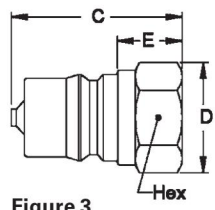

Figure 3

Plugs (Male)

Part Number HK1-8 Series 303 Stainless Steel	316 Stainless Steel	Body Size	ISO Size	Thread Size (Female)			Fig.	Dimensions							
				NPTF	BSPB	SAE		C (in)	D (in)	E (in)	Hex (in)	C (mm)	D (mm)	E (mm)	Hex (mm)
LL1K11	ML1K11	1/8	5	1/8-27	-	-	3	1.26	0.65	0.44	0.56	32.0	16.5	11.2	14.2
LL1K4	-	1/8	5	-	-	7/16-20	3	1.41	0.79	0.59	0.69	35.8	20.1	15.0	17.5
LL2K16	ML2K16	1/4	6.3	1/4-18	-	-	3	1.52	0.87	0.56	0.75	38.6	22.1	14.2	19.1
LL2K16BS	ML2K16BS	1/4	6.3	-	1/4-19	-	3	1.52	0.87	0.56	0.75	38.6	22.1	14.2	19.1
LL2K6	-	1/4	6.3	-	-	9/16-18	3	1.66	1.01	0.70	0.88	42.2	25.7	17.8	22.4
LL3K21	ML3K21	3/8	10	3/8-18	-	-	3	1.76	1.01	0.61	0.88	44.7	25.7	15.5	22.4
LL3K21BS	ML3K21BS	3/8	10	-	3/8-19	-	3	1.76	1.01	0.61	0.88	44.7	25.7	15.5	22.4
LL3K8	-	3/8	10	-	-	3/4-16	3	1.94	1.15	0.79	1.00	49.3	29.2	20.1	25.4
LL4KP26	ML4KP26	1/2	12.5	1/2-14	-	-	3	2.03	1.30	0.76	1.13	51.6	33.0	19.3	28.7
LL4KP26BS	ML4KP26BS	1/2	12.5	-	1/2-14	-	3	2.03	1.30	0.76	1.13	51.6	33.0	19.3	28.7
LL4KP10	-	1/2	12.5	-	-	7/8-14	3	2.11	1.37	0.84	1.19	53.6	34.8	21.3	30.2
LL6KP31	ML6KP31	3/4	20	3/4-14	-	-	3	2.36	1.52	0.71	1.31	59.9	38.6	18.0	33.3
LL6KP31BS	ML6KP31BS	3/4	20	-	3/4-14	-	3	2.36	1.52	0.71	1.31	59.9	38.6	18.0	33.3
LL6KP12	-	3/4	20	-	-	1 1/16-12	3	2.54	1.59	0.89	1.38	64.5	40.4	22.6	35.1
LL8KP36	ML8KP36	1	25	1-11 1/2	-	-	3	2.85	1.88	0.97	1.63	72.4	47.8	24.6	41.4
LL8KP36BS	ML8KP36BS	1	25	-	1-11	-	3	2.85	1.88	0.97	1.63	72.4	47.8	24.6	41.4
LL8KP16	-	1	25	-	-	1 1/16-12	3	2.85	2.17	0.97	1.88	72.4	55.1	24.6	47.8

C=Overall Length, D=Maximum Diameter, E=Exposed Length when Connected
To obtain connected length of coupling, add dimensions A (Fig. 1) and E (Fig. 3) together.

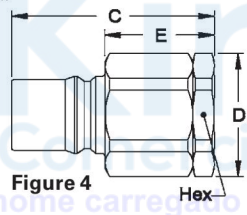

Figure 4

Plugs (Male)

Part Number HK10/12/20 Series 303 Stainless Steel	Body Size	ISO Size	Thread Size (Female)		Fig.	Dimensions							
			NPTF	BSPB		C (in)	D (in)	E (in)	Hex (in)	C (mm)	D (mm)	E (mm)	Hex (mm)
LL10K41*	1 1/4	-	1 1/4-11 1/2	-	4	4.25	2.74	2.33	2.38	108.0	69.6	59.2	60.5
LL10K41BS*	1 1/4	-	-	1 1/4-11	4	4.25	2.74	2.33	2.38	108.0	69.6	59.2	60.5
LL12K41	1 1/2	40	1 1/4-11 1/2	-	4	4.76	2.74	2.67	2.38	120.9	69.6	67.8	60.5
LL12K41BS	1 1/2	40	-	1 1/4-11	4	4.76	2.74	2.67	2.38	120.9	69.6	67.8	60.5
LL12K46	1 1/2	40	1 1/2-11 1/2	-	4	4.76	2.74	2.67	2.38	120.9	69.6	67.8	60.5
LL12K46BS	1 1/2	40	-	1 1/2-11	4	4.76	2.74	2.67	2.38	120.9	69.6	67.8	60.5
LL20K51	2 1/2	50	2-11 1/2	-	4	5.49	4.33	2.97	3.75	139.4	110.0	75.4	95.3
LL20K51BS	2 1/2	50	-	2-11	4	5.49	4.33	2.97	3.75	139.4	110.0	75.4	95.3
LL20K56	2 1/2	50	2 1/2-8	-	4	6.08	4.33	3.56	3.75	154.4	110.0	90.4	95.3
LL20K56BS	2 1/2	50	-	2 1/2-11	4	6.08	4.33	3.56	3.75	154.4	110.0	90.4	95.3
LL20K61	2 1/2	50	3-8	-	4	6.94	4.62	4.42	4.00	176.3	117.3	112.3	101.6
LL20K61BS	2 1/2	50	-	3-11	4	6.94	4.62	4.42	4.00	176.3	117.3	112.3	101.6

C=Overall Length, D=Maximum Diameter, E=Exposed Length when Connected
* ISO 7241-1 Series B does not include 1-1/4 inch body size couplings; therefore, Series 10HK is not covered by this standard.
To obtain connected length of coupling, add dimensions A (Fig. 2) and E (Fig. 4) together.

Dust Plugs and Dust Caps Accessories

Coupling Series	Plug Dust Cap Part No.		Socket Dust Plug Part No.	
	Metal	Vinyl	Metal	Vinyl
1HK	PDC1HK*	PPDC1HK	SDC1HK*	PSDC1HK
2HK	PDC2HK*	PPDC2HK	SDC2HK*	PSDC2HK
3HK	PDC3HK*	PPDC3HK	SDC3HK*	PSDC3HK
4HK	PDC4HK**	PPDC4HK(RD)***	SDC4HK**	PSDC4HK(RD)***
6HK	PDC6HK**	PPDC6HK(RD)***	SDC6HK**	PSDC6HK(RD)***
8HK	PDC8HK**	PPDC8HK(RD)***	SDC8HK**	PSDC8HK(RD)***
12HK	PDC12HK*	-	SDC12HK*	-
20HK	PDC20HK*	-	SDC20HK*	-



*Brass **Aluminum ***Offered in red by adding RD to end of part number

HKFR Series ISO 7241-1 BOP



Eaton's HKFR Series is a quick disconnect hydraulic coupling for hazardous Blow Out Preventer (BOP) service in the Oil and Gas Industry. The HKFR Series meets or exceeds the ISO 7241-1 B standard.

FLUID TRANSFER
AND HYDRAULIC

PNEUMATIC

SPECIAL APPLICATIONS

DIAGNOSTIC

AGRICULTURE

REFRIGERANT

Product Features

- BOP designation and red color is marked on the Socket/Female and Plug/Male halves
- Sleeve lock is standard
- Lloyd's Register Certification
- Meets or exceeds ISO 7241-1 Series B standard
- Utilizes HK Series dust caps and dust plugs
- Standard body material: 316 stainless steel, zinc trivalent plated steel
- Standard seal material: Buna-N

Physical Characteristics

Series	Body Size (in)	Max. Operating Pressure Connected		Min. Burst Pressure		Rated Flow		Fluid Loss cc. max
		(bar)	(psi)	(bar)	(psi)	(lpm)	(gpm)	
4HKFR	1/2	482	7,000	1,931	28,000	28	7.5	3.5
6HKFR	3/4	344	5,000	1,251	18,150	66	17.5	9.3
8HKFR	1	344	5,000	1,379	20,000	95	25	16.9
ML8HKFR	1	344	5,000	1,379	20,000	95	25	16.9

Applications & Markets

- Oil and gas

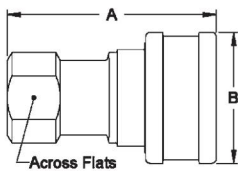

Figure 1

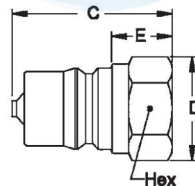

Figure 2

Lloyd's Register Certification

All of the above items carry a Lloyd's Registry Certificate for fire conditions stated in API 16D and EUB Directive 36. These parts meet the requirements that state couplings shall be capable of maintaining pressure when exposed to a 700°C (1,300°F) temperature for a five-minute period. Testing for this certification was conducted at the following pressures in the connected condition:

4HFR26/4KFR26:	3,000 PSI/206 BAR
6HFR31/6KFR31:	3,000 PSI/206 BAR
8HFR36/8KFR36:	4,000 PSI/275 BAR
ML8HFR36/ML8KFR36:	4,000 PSI/275 BAR

Female End Connections

Part Number	Coupling Type	Body Size	Thread	Fig.	Dimensions			A	B	Across Flats
					A	B	Across Flats			
					(in)	(in)	(in)	(mm)	(mm)	(mm)
4HFR26	Socket/Female	1/2	1/2-14 NPTF	1	2.96	1.86	1.13	75.2	47.2	28.7
6HFR31	Socket/Female	3/4	3/4-14 NPTF	1	3.48	2.22	1.31	88.4	56.4	33.3
8HFR36	Socket/Female	1	1-1 1/2 NPTF	1	4.13	2.61	1.75	104.9	66.3	44.5
ML8HFR36*	Socket/Female	1	1-1 1/2 NPTF	1	4.13	2.61	1.75	104.9	66.3	44.5

*Stainless Steel

Plugs/Males

Part Number	Coupling Type	Body Size	Thread	Fig.	Dimensions				C	D	E	Hex
					C	D	E	Hex				
					(in)	(in)	(in)	(in)	(mm)	(mm)	(mm)	(mm)
4KFR26	Plug/Male	1/2	1/2-14 NPTF	2	2.03	1.3	0.76	1.13	51.6	33.0	19.3	28.7
6KFR31	Plug/Male	3/4	3/4-14 NPTF	2	2.36	1.52	0.71	1.31	59.9	38.6	18.0	33.3
8KFR36	Plug/Male	1	1-11 1/2 NPTF	2	2.85	1.88	0.97	1.63	72.4	47.8	24.6	41.4
ML8KFR36*	Plug/Male	1	1-11 1/2 NPTF	2	2.85	1.88	0.97	1.63	72.4	47.8	24.6	41.4

*Stainless Steel

5600 Series ISO 7241-1 A Interchange



Eaton's 5600 Series features a rugged ball latch mechanism with self-sealing poppet valves in a wide array of port configurations and multiple valved and non-valved configurations.

Product Features

- Meets dimensional requirements to ISO standard 7241-1 Series A
- Self-sealing poppet valve provides excellent high and low pressure sealing
- Streamlined valving provides minimum pressure drop
- Standard seal materials: Buna-N, EPDM and FKM
- Standard body material: High resistance carbon steel with zinc trivalent plating (Brass poppet guide in -04 size)

Physical Characteristics

Body Size (in)	Max. Operating Pressure		Min. Burst Pressure Connected		Vacuum Connected Only	Rated Flow		Air Inclusion	Fluid Loss
	(bar)	(psi)	(bar)	(psi)	(in./Hg)	(lpm)	(gpm)	cc. max.	cc.max.
1/4	350	5,000	1,050	15,000	28	4	1	0.50	0.50
3/8	280	4,000	840	12,000	28	23	6	1.5	1.3
5/8	280	4,000	840	12,000	28	45	12	2.8	2.8
3/4	280	4,000	840	12,000	28	106	28	10.0	8.2
1	280	4,000	840	12,000	28	189	50	14.2	14.2

Applications & Markets

- Hydraulic fluid transfer
- Agricultural equipment
- Construction equipment
- Dump, snow plow and maintenance vehicles
- In-plant manufacturing

Flow Data

Pressure Drop Versus Flow Graph

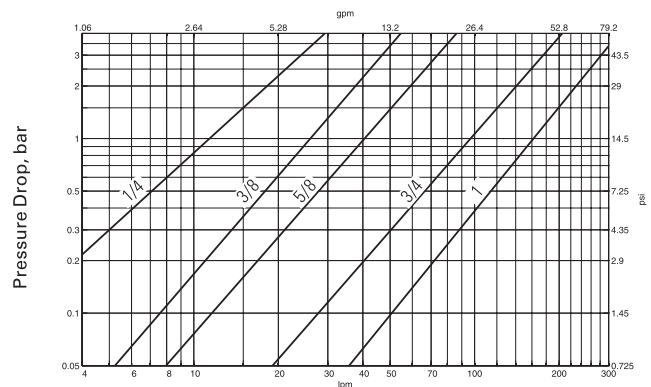

Gallons Per Minute Flow
Test Fluid: MIL-H-5606 Oil at 100°F

5600 Series ISO 7241-1 A Interchange

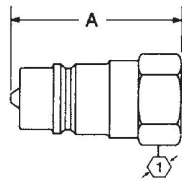

Figure 1

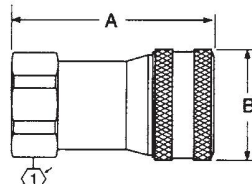

Figure 2

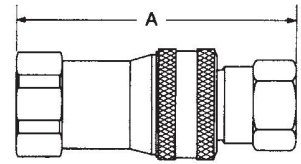

Figure 3

Dimensions (Female NPT, Valved)

Part Number	Buna-N	FKM	EPDM	Coupling Type	Body Size	Port Size	Thread	Type	Fig.	Dimensions					
										A	B	Hex ①			
										mm	(in)	mm	(in)	mm	(in)
5602-2-4S	FD56-1062-02-04		5644-2-4S	Plug/Male	1/4	1/8	1/8-27	Female NPT	1	31.5	(1.24)	-	-	14.2	(.56)
5601-2-4S	FD56-1064-02-04		5643-2-4S	Socket/Female	1/4	1/8	1/8-27	Female NPT	2	46	(1.81)	27.4	(1.08)	22.4	(.88)
5600-2-4S	FD56-1065-02-04		5642-2-4S	Complete	1/4	1/8	1/8-27	Female NPT	3	61.5	(2.42)	-	-	-	-
5602-4-4S	FD56-1062-04-04		5644-4-4S	Plug/Male	1/4	1/4	1/4-18	Female NPT	1	33.3	(1.31)	-	-	19.1	(.75)
5601-4-4S	FD56-1064-04-04		5643-4-4S	Socket/Female	1/4	1/4	1/4-18	Female NPT	2	46	(1.81)	27.4	(1.08)	22.4	(.88)
5600-4-4S	FD56-1065-04-04		5642-4-4S	Complete	1/4	1/4	1/4-18	Female NPT	3	63.2	(2.49)	-	-	-	-
5602-6-6S	FD56-1062-06-06		5644-6-6S	Plug/Male	3/8	3/8	3/8-18	Female NPT	1	37.3	(1.47)	-	-	22.4	(.88)
5601-6-6S	FD56-1064-06-06		5643-6-6S	Socket/Female	3/8	3/8	3/8-18	Female NPT	2	54.6	(2.15)	31.2	(1.23)	25.4	(1.00)
5600-6-6S	FD56-1065-06-06		5642-6-6S	Complete	3/8	3/8	3/8-18	Female NPT	3	71.1	(2.80)	-	-	-	-
5602-8-10S	FD56-1062-08-10		5644-8-10S	Plug/Male	5/8	1/2	1/2-14	Female NPT	1	51.3	(2.02)	-	-	26.9	(1.06)
5601-8-10S	FD56-1064-08-10		5643-8-10S	Socket/Female	5/8	1/2	1/2-14	Female NPT	2	66.3	(2.61)	38.1	(1.50)	30.2	(1.19)
5600-8-10S	FD56-1065-08-10		5642-8-10S	Complete	5/8	1/2	1/2-14	Female NPT	3	96	(3.78)	-	-	-	-
5602-12-10S	FD56-1062-12-10		5644-12-10S	Plug/Male	5/8	3/4	3/4-14	Female NPT	1	54.9	(2.16)	-	-	35.1	(1.38)
5601-12-10S	FD56-1064-12-10		5643-12-10S	Socket/Female	5/8	3/4	3/4-14	Female NPT	2	66.3	(2.61)	38.1	(1.50)	33.3	(1.31)
5600-12-10S	FD56-1065-12-10		5642-12-10S	Complete	5/8	3/4	3/4-14	Female NPT	3	103.1	(4.06)	-	-	-	-
5602-12-12S	FD56-1062-12-12		5644-12-12S	Plug/Male	3/4	3/4	3/4-14	Female NPT	1	64.8	(2.55)	-	-	35.1	(1.38)
5601-12-12S	FD56-1064-12-12		5643-12-12S	Socket/Female	3/4	3/4	3/4-14	Female NPT	2	82.6	(3.25)	46	(1.81)	38.1	(1.50)
5600-12-12S	FD56-1065-12-12		5642-12-12S	Complete	3/4	3/4	3/4-14	Female NPT	3	115.8	(4.56)	-	-	-	-
5602-16-16S	FD56-1062-16-16		5644-16-16S	Plug/Male	1	1	1-11 1/2	Female NPT	1	78.7	(3.10)	-	-	41.1	(1.62)
5601-16-16S	FD56-1064-16-16		5643-16-16S	Socket/Female	1	1	1-11 1/2	Female NPT	2	97	(3.82)	53.3	(2.10)	42.9	(1.69)
5600-16-16S	FD56-1065-16-16		5642-16-16S	Complete	1	1	1-11 1/2	Female NPT	3	123.4	(4.86)	-	-	-	-

Dimensions (Female NPT, Valved with Sleeve Lock)

Part Number	Buna-N	Coupling Type	Body Size	Port Size	Thread	Type	Fig.	Dimensions					
								A	B	Hex ①			
								mm	(in)	mm	(in)	mm	(in)
FD56-1239-08-10		Socket/Female	5/8	1/2	1/2-14	Female NPT	2	66.3	(2.61)	38.1	(1.50)	30.2	(1.19)
FD56-1239-12-12		Socket/Female	3/4	3/4	3/4-14	Female NPT	2	82.6	(3.25)	46.7	(1.84)	38.1	(1.50)
FD56-1239-16-16		Socket/Female	1	1	1-11 1/2	Female NPT	2	97.0	(3.82)	54.1	(2.13)	42.9	(1.69)

FLUID TRANSFER
AND HYDRAULIC

PNEUMATIC

SPECIAL APPLICATIONS

DIAGNOSTIC

AGRICULTURE

REFRIGERANT

5600 Series ISO 7241-1 A Interchange

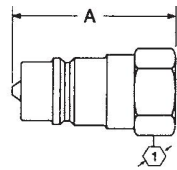

Figure 1

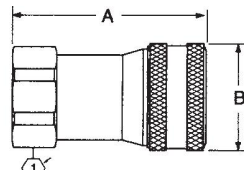

Figure 2

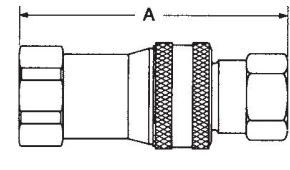

Figure 3

Dimensions (Female NPT, Non-Valved)

Part Number Buna-N	FKM	EPDM	Coupling Type	Body Size	Port Size	Thread	Type	Fig.	Dimensions		Hex Ⓛ			
									A	B	mm	(in)	mm	(in)
FD56-1037-04-04	FD56-1037-04-04	FD56-1037-04-04	Plug/Male*	1/4	1/4	1/4-18	Female NPT	1	31.5	(1.24)	-	-	19.1	(.75)
FD56-1225-04-04	FD56-1207-04-04	FD56-1204-04-04	Socket/Female	1/4	1/4	1/4-18	Female NPT	2	46.0	(1.81)	27.4	(1.08)	22.4	(.88)
FD56-1226-04-04	FD56-1208-04-04	FD56-1205-04-04	Complete*	1/4	1/4	1/4-18	Female NPT	3	63.2	(2.49)	-	-	-	-
FD56-1037-06-06	FD56-1037-06-06	FD56-1037-06-06	Plug/Male*	3/8	3/8	3/8-18	Female NPT	1	35.6	(1.40)	-	-	22.4	(.88)
FD56-1225-06-06	FD56-1207-06-06	FD56-1204-06-06	Socket/Female	3/8	3/8	3/8-18	Female NPT	2	54.6	(2.15)	31.2	(1.23)	25.4	(1.00)
FD56-1226-06-06	FD56-1208-06-06	FD56-1205-06-06	Complete*	3/8	3/8	3/8-18	Female NPT	3	71.1	(2.80)	-	-	-	-
FD56-1037-08-10	FD56-1037-08-10	FD56-1037-08-10	Plug/Male*	5/8	1/2	1/2-14	Female NPT	1	48	(1.89)	-	-	26.9	(1.06)
FD56-1225-08-10	FD56-1207-08-10	FD56-1204-08-10	Socket/Female	5/8	1/2	1/2-14	Female NPT	2	66.3	(2.61)	38.1	(1.50)	30.2	(1.19)
FD56-1226-08-10	FD56-1208-08-10	FD56-1205-08-10	Complete*	5/8	1/2	1/2-14	Female NPT	3	96	(3.78)	-	-	-	-
FD56-1037-12-12	FD56-1037-12-12	FD56-1037-12-12	Plug/Male*	3/4	3/4	3/4-14	Female NPT	1	57.9	(2.28)	-	-	-	-
FD56-1225-12-12	FD56-1207-12-12	FD56-1204-12-12	Socket/Female	3/4	3/4	3/4-14	Female NPT	2	82.6	(3.25)	46.0	(1.81)	38.1	(1.50)
FD56-1226-12-12	FD56-1208-12-12	FD56-1205-12-12	Complete*	3/4	3/4	3/4-14	Female NPT	3	113.3	(4.46)	-	-	-	-
FD56-1037-16-16	FD56-1037-16-16	FD56-1037-16-16	Plug/Male*	1	1	1-11 1/2	Female NPT	1	70.4	(2.77)	-	-	41.1	(1.62)
FD56-1225-16-16	FD56-1207-16-16	FD56-1204-16-16	Socket/Female	1	1	1-11 1/2	Female NPT	2	97	(3.82)	53.3	(2.10)	42.9	(1.69)
FD56-1226-16-16	FD56-1208-16-16	FD56-1205-16-16	Complete*	1	1	1-11 1/2	Female NPT	3	140.7	(5.54)	-	-	-	-

Note: Will not operate with valved coupling halves; no valve actuator. *Male halves contain no seals.

Dimensions (Female NPT, Pusher-Style Valving)

Part Number Buna-N	FKM	EPDM	Coupling Type	Body Size	Port Size	Thread	Type	Fig.	Dimensions		Hex Ⓛ			
									A	B	mm	(in)	mm	(in)
FD56-1125-04-04	FD56-1125-04-04	FD56-1125-04-04	Plug/Male	1/4	1/4	1/4-18	Female NPT	1	31.5	(1.24)	-	-	19	(.75)
FD56-1123-04-04	FD56-1201-04-04	FD56-1196-04-04	Socket/Female	1/4	1/4	1/4-18	Female NPT	2	46	(1.81)	27.4	(1.08)	22.4	(.88)
FD56-1125-06-06	FD56-1125-06-06	FD56-1125-06-06	Plug/Male	3/8	3/8	3/8-18	Female NPT	1	35.6	(1.40)	-	-	22.4	(.88)
FD56-1123-06-06	FD56-1201-06-06	FD56-1196-06-06	Socket/Female	3/8	3/8	3/8-18	Female NPT	2	54.6	(2.15)	31.2	(1.23)	25.4	(1.00)
FD56-1125-08-10	FD56-1125-08-10	FD56-1125-08-10	Plug/Male	5/8	1/2	1/2-14	Female NPT	1	48	(1.89)	-	-	26.9	(1.06)
FD56-1123-08-10	FD56-1201-08-10	FD56-1196-08-10	Socket/Female	5/8	1/2	1/2-14	Female NPT	2	66.3	(2.61)	38.1	(1.50)	30.2	(1.19)
FD56-1125-12-12	FD56-1125-12-12	FD56-1125-12-12	Plug/Male	3/4	3/4	3/4-14	Female NPT	1	57.9	(2.28)	-	-	35.1	(1.38)
FD56-1123-12-12	FD56-1201-12-12	FD56-1196-12-12	Socket/Female	3/4	3/4	3/4-14	Female NPT	2	82.6	(3.25)	46	(1.81)	38.1	(1.50)
FD56-1125-16-16	FD56-1125-16-16	FD56-1125-16-16	Plug/Male	1	1	1-11 1/2	Female NPT	1	70.4	(2.77)	-	-	41.1	(1.62)
FD56-1123-16-16	FD56-1201-16-16	FD56-1196-16-16	Socket/Female	1	1	1-11 1/2	Female NPT	2	97	(3.82)	53.3	(2.10)	42.9	(1.69)

Note: Incorporates a pusher device to open mating valved coupling halves.

Dimensions (Plug/Male Half, Female BSP/Valved)

Part Number Buna-N	Body Size	Thread	Fig.	Dimensions		B		Hex Ⓛ	
				A (in)	mm	(in)	mm	(in)	mm
G5623-4-4	1/4	G 1/4	1	(1.34)	34	-	-	(0.75)	19.0
G5623-6-6	3/8	G 3/8	1	(1.50)	38	-	-	(0.91)	23.0
G5623-8-10	5/8	G 1/2	1	(1.73)	44	-	-	(1.06)	27.0
G5623-12-12	3/4	G 3/4	1	(2.17)	55	-	-	(1.38)	35.0
G5623-16-16	1	G 1	1	(2.52)	64	-	-	(1.61)	41.0

5600 Series ISO 7241-1 A Interchange

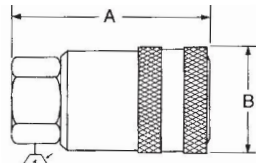

Figure 4

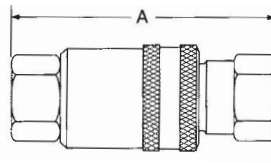

Figure 5

Dimensions (Socket/Female Half, Female BSP/Valved)

Part Number Buna-N	Body Size	Thread	Fig.	Dimensions		B		Hex ①	
				A (in)	mm	(in)	mm	(in)	mm
G5622-4-4	1/4	G 1/4	2	(1.89)	48	(1.04)	26.3	(0.87)	22.0
G5622-6-6	3/8	G 3/8	2	(2.20)	56	(1.18)	30	(1.06)	27.0
G5622-8-10	5/8	G 1/2	2	(2.60)	66	(1.51)	38.3	(1.06)	27.0
G5622-12-12	3/4	G 3/4	2	(3.25)	82.5	(1.89)	48	(1.57)	40.0
G5622-16-16	1	G 1	2	(3.86)	98	(2.09)	53	(1.97)	50.0

Dimensions (Female NPT, Connect Under Pressure Style)

Part Number Buna-N	FKM	EPDM	Type	Coupling Size	Body Size	Port Thread	Type	Fig.	Dimensions		Hex ①	
									A mm (in)	B mm (in)	mm (in)	mm (in)
5602-8-10S	FD56-1062-08-10	5644-8-10S	Plug/Male	5/8	1/2	1/2-14	Female NPT Valved	1	51.3 (2.02)	-	-	26.9 (1.06)
5651-8-10S	FD56-1070-08-10	565007-8-10S	Socket/Female	5/8	1/2	1/2-14	Female NPT	4	73.2 (2.88)	38.1 (1.50)	26.9 (1.06)	-
5650-8-10S	FD56-1071-08-10	565006-8-10S	Complete	5/8	1/2	1/2-14	Female NPT	5	98.8 (3.89)	-	-	-
5602-12-10S	FD56-1062-12-10	5644-12-10S	Plug/Male	5/8	3/4	3/4-14	Female NPT Valved	1	54.9 (2.16)	-	-	35.1 (1.38)
5651-12-10S	FD56-1070-12-10	565007-12-10S	Socket/Female	5/8	3/4	3/4-14	Female NPT	4	83.8 (3.30)	38.1 (1.50)	31.8 (1.25)	-
5650-12-10S	FD56-1071-12-10	565006-12-10S	Complete	5/8	3/4	3/4-14	Female NPT	5	113 (4.45)	-	-	-

Dimensions (Female, SAE O-Ring Valved)

Part Number Buna-N	FKM	EPDM	Coupling Type	Body Size	Port Size	Thread	Type	Fig.	Dimensions		Hex ①	
									A mm (in)	B mm (in)	mm (in)	mm (in)
5610-4-4S	FD56-1072-04-04	560078-4-4S	Plug/Male	1/4	7/16	7/16-20	Female SAE O-Ring	1	32.5 (1.28)	-	-	15.7 (.62)
5608-4-4S	FD56-1074-04-04	FD56-1012-04-04S	Socket/Female	1/4	7/16	7/16-20	Female SAE O-Ring	2	46 (1.81)	27.4 (1.08)	22.4 (.88)	-
5606-4-4S	FD56-1075-04-04	FD56-1009-04-04S	Complete	1/4	7/16	7/16-20	Female SAE O-Ring	3	64.3 (2.53)	-	-	-
5610-6-6S	FD56-1072-06-06	560078-6-6S	Plug/Male	3/8	9/16	9/16-18	Female SAE O-Ring	1	38.1 (1.50)	-	-	22.4 (.88)
5608-6-6S	FD56-1074-06-06	FD56-1012-06-06S	Socket/Female	3/8	9/16	9/16-18	Female SAE O-Ring	2	54.6 (2.15)	31.2 (1.23)	25.4 (1.00)	-
5606-6-6S	FD56-1075-06-06	FD56-1009-06-06S	Complete	3/8	9/16	9/16-18	Female SAE O-Ring	3	72.1 (2.84)	-	-	-
5610-8-10S	FD56-1072-08-10	560078-8-10S	Plug/Male	5/8	3/4	3/4-16	Female SAE O-Ring	1	51.6 (2.03)	-	-	26.9 (1.06)
5608-8-10S	FD56-1074-08-10	FD56-1012-08-10S	Socket/Female	5/8	3/4	3/4-16	Female SAE O-Ring	2	66.3 (2.61)	38.1 (1.50)	30.2 (1.19)	-
5606-8-10S	FD56-1075-08-10	FD56-1009-08-10S	Complete	5/8	3/4	3/4-16	Female SAE O-Ring	3	96 (3.78)	-	-	-
5610-10-10S	FD56-1072-10-10	560078-10-10S	Plug/Male	5/8	7/8	7/8-14	Female SAE O-Ring	1	52.8 (2.08)	-	-	28.4 (1.12)
5608-10-10S	FD56-1074-10-10	FD56-1012-10-10S	Socket/Female	5/8	7/8	7/8-14	Female SAE O-Ring	2	66.3 (2.61)	38.1 (1.50)	30.2 (1.19)	-
5606-10-10S	FD56-1075-10-10	FD56-1009-10-10S	Complete	5/8	7/8	7/8-14	Female SAE O-Ring	3	98.6 (3.88)	-	-	-
5610-12-12S	FD56-1072-12-12	560078-12-12S	Plug/Male	3/4	1 1/16	1 1/16-12	Female SAE O-Ring	1	64.8 (2.55)	-	-	35.1 (1.38)
5608-12-12S	FD56-1074-12-12	FD56-1012-12-12S	Socket/Female	3/4	1 1/16	1 1/16-12	Female SAE O-Ring	2	82.6 (3.25)	46 (1.81)	38.1 (1.50)	-
5606-12-12S	FD56-1075-12-12	FD56-1009-12-12S	Complete	3/4	1 1/16	1 1/16-12	Female SAE O-Ring	3	115.8 (4.56)	-	-	-
5610-16-16S	FD56-1072-16-16	560078-16-16S	Plug/Male	1	1 5/16	1 5/16-12	Female SAE O-Ring	1	78.7 (3.10)	-	-	41.1 (1.62)
5608-16-16S	FD56-1074-16-16	FD56-1012-16-16S	Socket/Female	1	1 5/16	1 5/16-12	Female SAE O-Ring	2	97.3 (3.83)	53.3 (2.10)	42.9 (1.69)	-
5606-16-16S	FD56-1075-16-16	FD56-1009-16-16S	Complete	1	1 5/16	1 5/16-12	Female SAE O-Ring	3	140.7 (5.54)	-	-	-

Dimensions (Female SAE O-Ring, Valved with Sleeve Lock)

Part Number Buna-N	FKM	EPDM	Coupling Type	Body Size	Port Size	Thread	Type	Fig.	Dimensions		Hex ①	
									A mm (in)	B mm (in)	mm (in)	mm (in)
FD56-1270-06-06	-	-	Socket/Female	3/8	9/16	9/16-18	Female SAE O-Ring	3	54.6 (2.15)	31.8 (1.23)	25.4 (1.00)	-
FD56-1270-08-10	-	-	Socket/Female	5/8	3/4	3/4-16	Female SAE O-Ring	3	66.3 (2.61)	38.1 (1.50)	30.2 (1.19)	-
FD56-1270-12-12	-	-	Socket/Female	3/4	1 1/16	1 1/16-12	Female SAE O-Ring	3	82.6 (3.25)	46.7 (1.81)	38.1 (1.50)	-
FD56-1270-16-16	-	-	Socket/Female	1	1 5/16	1 5/16-12	Female SAE O-Ring	3	97.0 (3.82)	54.1 (2.10)	42.9 (1.69)	-

5600 Series ISO 7241-1 A Interchange

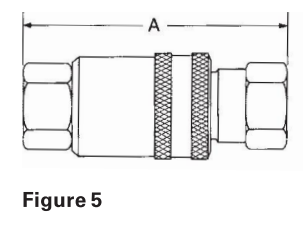
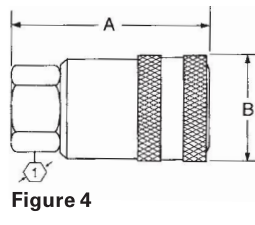
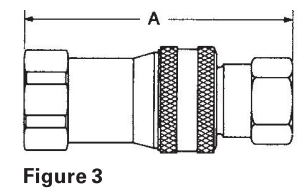
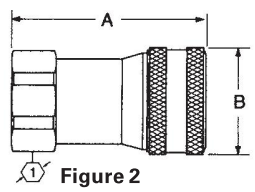
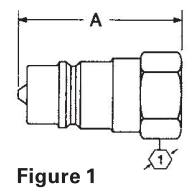

Dimensions (Female, SAE O-Ring Non-Valved)

Part Number	Buna-N	FKM	EPDM	Coupling Type	Body Size	Port Size	Thread	Type	Fig.	Dimensions					
										A	B	Hex $\text{\textcircled{T}}$			
										mm	(in)	mm	(in)	mm	(in)
5620-8-10S	FD56-1221-08-10	FD56-1221-08-10	Plug/Male	5/8	3/4	3/4-16	Female SAE O-Ring	1	48.0	(1.89)	25.9	(1.02)	26.9	(1.06)	
5691-8-10S	FD56-1233-08-10	FD56-1209-08-10	Socket/Female	5/8	3/4	3/4-16	Female SAE O-Ring	2	66.3	(2.61)	38.1	(1.50)	30.2	(1.19)	
5690-8-10S	FD56-1234-08-10	FD56-1210-08-10	Complete	5/8	3/4	3/4-16	Female SAE O-Ring	3	96.0	(3.78)	-	-	-	-	
5620-12-12S	FD56-1221-12-12	FD56-1221-12-12	Plug/Male	3/4	1 1/16	1 1/16-12	Female SAE O-Ring	1	57.9	(2.28)	30.7	(1.21)	35.1	(1.38)	
5691-12-12S	FD56-1233-12-12	FD56-1209-12-12	Socket/Female	3/4	1 1/16	1 1/16-12	Female SAE O-Ring	2	82.6	(3.25)	46.0	(1.81)	38.1	(1.50)	
5690-12-12S	FD56-1234-12-12	FD56-1210-12-12	Complete	3/4	1 1/16	1 1/16-12	Female SAE O-Ring	3	115.8	(4.56)	-	-	-	-	
5620-16-16S	FD56-1221-16-16	FD56-1221-16-16	Plug/Male	1	1 5/16	1 5/16-12	Female SAE O-Ring	1	70.4	(2.77)	36.8	(1.45)	41.1	(1.62)	
5691-16-16S	FD56-1233-16-16	FD56-1209-16-16	Socket/Female	1	1 5/16	1 5/16-12	Female SAE O-Ring	2	103.9	(4.09)	54.6	(2.15)	47.8	(1.88)	
5690-16-16S	FD56-1234-16-16	FD56-1210-16-16	Complete	1	1 5/16	1 5/16-12	Female SAE O-Ring	3	140.0	(5.51)	-	-	-	-	

Dust Caps

Part Number	Body Size (in)
5657-4	1/4
5657-6	3/8
5657-10	5/8
5657-12	3/4
5657-16	1



Dust Cap

Break Away Frame

Part Number	Body Size (in)
5603	5/8



Break Away Frame

Dust Plugs

Part Number	Body Size (in)
5659-4	1/4
5659-6	3/8
5659-10	5/8
5659-12	3/4
5659-16	1



Dust Plug

5600 Series (Stainless Steel) ISO 7241-1 A Interchange



The Eaton 5600 Series is a rugged poppet style ball locking quick disconnect coupling. As the original manufacturer of the ISO 7241-1 A style coupling, Eaton has reinvented this quick disconnect coupling series to meet your application needs by offering a new stainless steel construction.

Product Features

- Self-sealing poppet valve provides excellent high and low pressure sealing
 - Stainless steel construction offers excellent corrosion resistance in tough environments
 - Standard body material: 303 stainless steel
 - Standard body material: Buna-N. EPDM and FKM seals are available upon request.
 - Available sizes include: 5/8", 3/4", 1"*
 - Female NPTF thread ends
- *Additional sizes are available upon request.

Physical Characteristics

Body Size (in)	Max. Operating Pressure Connected		Min. Burst Pressure		Rated Flow		Air Inclusion	Fluid Loss
	(bar)	(psi)	(bar)	(psi)	(lpm)	(gpm)	cc. max.	cc.max.
5/8	207	3,000	621	9,000	45	12	2.8	2.8
3/4	207	3,000	621	9,000	106	28	10	8.2
1	207	3,000	621	9,000	189	50	14.2	14.2

Applications & Markets

- Hydraulic and Fluid Transfer
- Agricultural Equipment
- Construction Equipment
- Steel Mills
- Plant Manufacturing and Processing Equipment
- Dump, Snow Plow, and Maintenance Vehicles

Flow Data

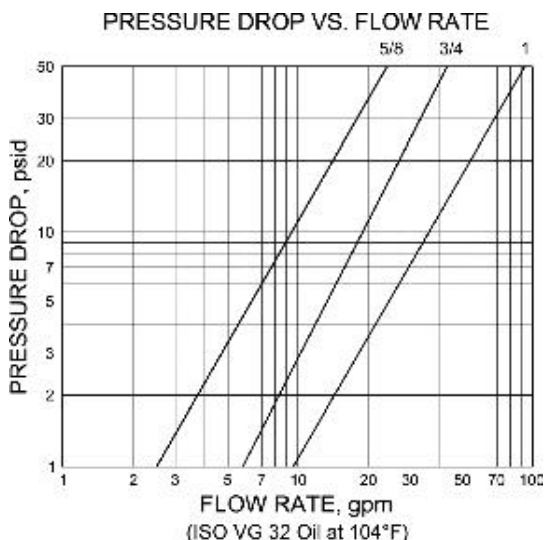

5600 Series (Stainless Steel) ISO 7241-1 A Interchange

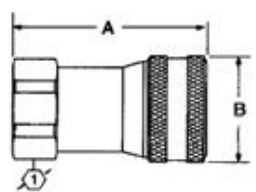

Figure 1

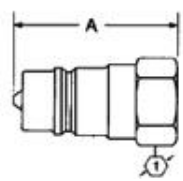

Figure 2

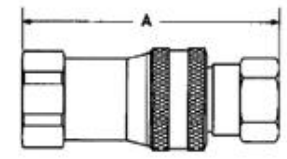

Figure 3

Female End Connections

Part Number	Coupling Type	Body Size	Thread	Fig.	Dimensions			Hex	A	B	Hex
					A	B	Hex				
					(in)	(in)	(in)	(mm)	(mm)	(mm)	
560024-8-10	Socket/Female	5/8	1/2-14 NPTF	1	2.61	1.5	1.19	66.3	38.1	30.2	
560024-12-12	Socket/Female	3/4	3/4-14 NPTF	1	3.25	1.81	1.50	82.6	46.0	38.1	
560024-16-16	Socket/Female	1	1 11-1/2 NPTF	1	3.82	2.1	1.69	97.0	53.3	42.9	

Plugs (Male)

Part Number	Coupling Type	Body Size	Thread	Fig.	Dimensions			Hex	A	B	Hex
					A	B	Hex				
					(in)	(in)	(in)	(mm)	(mm)	(mm)	
560049-8-10	Plug/Male	5/8	1/2-14 NPTF	2	2.02	-	1.06	51.3	-	26.9	
560049-12-12	Plug/Male	3/4	3/4-14 NPTF	2	2.55	-	1.38	64.8	-	35.1	
560049-16-16	Plug/Male	1	1 11-1/2 NPTF	2	3.1	-	1.62	78.7	-	41.1	

Complete Sets*

Part Number	Coupling Type	Body Size	Thread	Fig.	Dimensions	
					A	A
					(in)	(mm)
FD56-1001-08-10	Complete	5/8	1/2-14 NPTF	3	3.78	96.0
FD56-1001-12-12	Complete	3/4	3/4-14 NPTF	3	4.56	115.8
FD56-1001-16-16	Complete	1	1 11-1/2 NPTF	3	4.86	123.4

*Includes one socket/female and one plug/male half in the outlined size.

H5000 Series (Steel)



Eaton's H5000 Series steel quick disconnect coupling is a pull to connect double shut-off coupling. Featuring the original Eaton's Gromelle™ profile, it remains as the series users prefer when it comes to severe hydraulic applications such as high pressure, pressure impulses, heavy mechanical loads and frequent connection and disconnection cycles. The unique sleeve lock option offers a reliable solution and benefit to the end user when safety is a concern.

Product Features

- Proprietary profile
- Pull-to-connect with double shut-off valving
- Ball-locking
- Optional safety sleeve lock prevents accidental disconnections
- Optional dust caps and plugs (made of anodized aluminum)
- Pressure performance
- Standard body material: Zinc trivalent steel
- Standard seal material: NBR, FKM, EPDM
- The heat treatment of the plug and use of high strength steel for the socket sleeve provide superior mechanical and hydraulic performance. The design of the valve gives the coupling increased robustness when disconnected.

Physical Characteristics

Body Size (in)	Nominal Flow Diameter (mm)	Max. Operating Pressure* Non hazardous liquids & gases in Group 2		Hazardous liquids & gases in Group 1		Rated Flow**		Fluid Loss ml-cc.
		(bar)	(psi)	(bar)	(psi)	(lpm)	(gpm)	
1/8	3.8	1000	14500	1000	14500	6.1	1.61	0.4
1/4	5.7	700	10150	700	10150	11.6	3.06	1
3/8	7.6	600	8700	600	8700	16.7	4.41	2
1/2	10.3	500	7250	500	7250	25.5	6.74	2.5
3/4	14.2	400	5800	400	5800	55	14.53	5.5
1	16.5	300	4350	300	4350	87	22.98	9
1 1/4	20.5	200	2900	200	2900	140	36.98	23
1 1/2	25.8	150	2175	38	550	208	54.95	36
2	34.7	100	1450	28	405	357	94.3	70

* For pulsating pressures when disconnected apply a multiplier of 0.5
 ** Indicated values refer to a 1 bar/14.5 psi pressure drop.

European Pressure Equipment Directive

Couplings with nominal diameters up to and including 25 mm are designed and manufactured under Article 3.3 of the European Pressure Equipment Directive 97/23 EC. Couplings with nominal diameters greater than 25 mm are designed and manufactured in accordance with the stipulations of Module A of the European Pressure Equipment Directive 97/23 EC. They should not be used to convey unstable gases.
 Group 1 = Hazardous media / Group 2 = Other media

Applications & Markets

- Automobile
- Agriculture
- Construction
- Oil and Gas
- Railway
- Aeronautics
- Food processing
- Iron and Steel Industry
- Electronics
- Laboratories
- General hydraulic applications

Flow Data

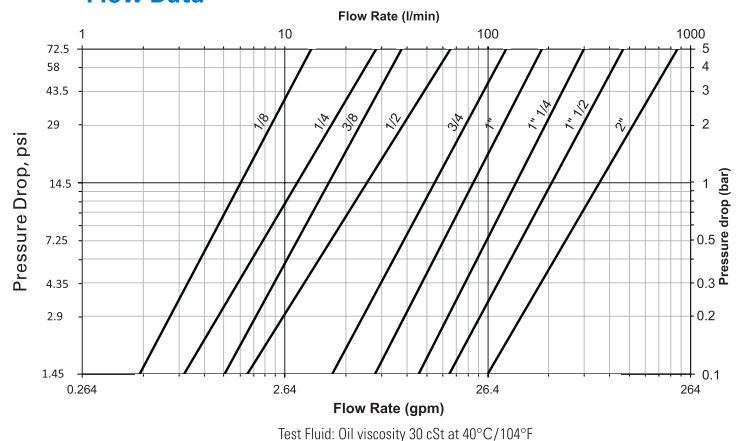

Seal Elastomer Data*

Seal Elastomer	Max. Operation Temperature Range
NBR (Nitrile)	-20°C +100°C/-4°F +212°F
FKM	-20°C +200°C/-4°F +392°F
EPDM (Ethylene-Propylene)**	-40°C +150°C/-40°F +302°F

* For reference only, based on Eaton recommended temperatures.

** In accordance with NF L 17-241 or NAS 1613 rev. 5

Contact Eaton technical support for further information on fluid compatibility.

H5000 Series (Steel)

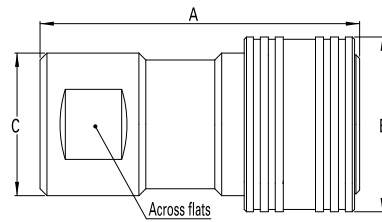

Figure 1

Sockets (Female)

Part Number			Body Size	Nominal Flow Diameter	Thread Size** (Female)			Dimensions								Weight		
NBR*	FKM	EPDM			(in)	(mm)	NPT	BSPP	Metric	Fig.	A (in)	B (in)	C (in)	Across flats (in)	A (mm)	B (mm)	C (mm)	Across flats (mm)
HA0500100	HA05001V0	HA05001E0	1/8	3.8	-	1/8-28	-	1	1.65	0.94	0.83	0.63	42	24	21	16	0.19	88
HA0520100	HA05201V0	HA05201E0	1/8	3.8	1/8-27	-	-	1	1.65	0.94	0.83	0.63	42	24	21	16	0.19	88
HA0530100	HA05301V0	HA05301E0	1/8	3.8	-	-	M10x100	1	1.65	0.94	0.83	0.63	42	24	21	16	0.19	88
HA0501100	HA05011V0	HA05011E0	1/4	5.7	-	1/4-19	-	1	1.97	1.10	0.94	0.75	50	28	24	19	0.27	122
HA0521100	HA05211V0	HA05211E0	1/4	5.7	1/4-18	-	-	1	1.97	1.10	0.94	0.75	50	28	24	19	0.27	122
HA0531100	HA05311V0	HA05311E0	1/4	5.7	-	-	M14x150	1	1.97	1.10	0.94	0.75	50	28	24	19	0.27	122
HA0502100	HA05021V0	HA05021E0	3/8	7.6	-	3/8-19	-	1	2.32	1.34	1.10	0.90	59	34	28	23	0.43	197
HA0522100	HA05221V0	HA05221E0	3/8	7.6	3/8-18	-	-	1	2.32	1.34	1.10	0.90	59	34	28	23	0.43	197
HA0532100	HA05321V0	HA05321E0	3/8	7.6	-	-	M18x150	1	2.32	1.34	1.10	0.90	59	34	28	23	0.43	197
HA0503100	HA05031V0	HA05031E0	1/2	10.3	-	1/2-14	-	1	2.71	1.50	1.22	1.06	69	38	31	27	0.50	226
HA0523100	HA05231V0	HA05231E0	1/2	10.3	1/2-14	-	-	1	2.71	1.50	1.22	1.06	69	38	31	27	0.50	226
HA0533100	HA05331V0	HA05331E0	1/2	10.3	-	-	M22x150	1	2.71	1.50	1.22	1.06	69	38	31	27	0.50	226
HA0504100	HA05041V0	HA05041E0	3/4	14.2	-	3/4-14	-	1	3.50	1.89	1.57	1.38	89	48	40	35	1.27	577
HA0524100	HA05241V0	HA05241E0	3/4	14.2	3/4-14	-	-	1	3.50	1.89	1.57	1.38	89	48	40	35	1.27	577
HA0534100	HA05341V0	HA05341E0	3/4	14.2	-	-	M27x150	1	3.50	1.89	1.57	1.38	89	48	40	35	1.27	577
HA0505100	HA05051V0	HA05051E0	1	16.5	-	1-11	-	1	3.89	2.05	1.77	1.61	99	52	45	41	1.59	720
HA0525100	HA05251V0	HA05251E0	1	16.5	1-11 1/2	-	-	1	3.89	2.05	1.77	1.61	99	52	45	41	1.59	720
-	HA05061V0	HA05061E0	1 1/4	20.5	-	1 1/4-11	-	1	5.20	2.95	2.44	2.16	132	75	62	55	4.77	2,165
-	HA05071V0	HA05071E0	1 1/2	25.8	-	1 1/2-11	-	1	5.90	3.35	2.95	2.56	150	85	75	65	7.72	3,500
-	HA05091V0	HA05091E0	2	34.7	-	2-11	-	1	6.69	3.82	3.35	2.95	170	97	85	75	10.67	4,840

* Body sizes 1 1/4, 1 1/2 and 2 are supplied with FKM seals as a standard.

** Alternative end connections available upon request.

To obtain connected length of coupling add dimensions A (Fig. 1) and J (Fig. 3) together.

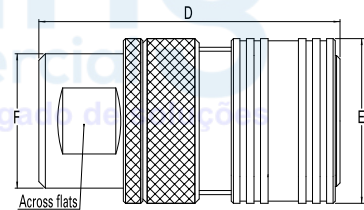

Figure 2

Sockets with Sleeve Lock (Female)

Part Number			Body Size	Nominal Flow Diameter	Thread Size** (Female)			Dimensions								Weight		
NBR*	FKM	EPDM			(in)	(mm)	NPT	BSPP	Metric	Fig.	D (in)	E (in)	F (in)	Across flats (in)	D (mm)	E (mm)	F (mm)	Across flats (mm)
HA0500300	HA05003V0	HA05003E0	1/8	3.8	-	1/8-28	-	2	1.65	0.94	0.83	0.63	42	24	21	16	0.19	91
HA0520300	HA05203V0	HA05203E0	1/8	3.8	1/8-27	-	-	2	1.65	0.94	0.83	0.63	42	24	21	16	0.19	91
HA0530300	HA05303V0	HA05303E0	1/8	3.8	-	-	M10x100	2	1.65	0.94	0.83	0.63	42	24	21	16	0.19	91
HA0501300	HA05013V0	HA05013E0	1/4	5.7	-	1/4-19	-	2	1.97	1.10	0.94	0.75	50	28	24	19	0.27	134
HA0521300	HA05213V0	HA05213E0	1/4	5.7	1/4-18	-	-	2	1.97	1.10	0.94	0.75	50	28	24	19	0.27	134
HA0531300	HA05313V0	HA05313E0	1/4	5.7	-	-	M14x150	2	1.97	1.10	0.94	0.75	50	28	24	19	0.27	134
HA0502300	HA05023V0	HA05023E0	3/8	7.6	-	3/8-19	-	2	2.32	1.34	1.10	0.90	59	34	28	23	0.43	225
HA0522300	HA05223V0	HA05223E0	3/8	7.6	3/8-18	-	-	2	2.32	1.34	1.10	0.90	59	34	28	23	0.43	225
HA0532300	HA05323V0	HA05323E0	3/8	7.6	-	-	M18x150	2	2.32	1.34	1.10	0.90	59	34	28	23	0.43	225
HA0503300	HA05033V0	HA05033E0	1/2	10.3	-	1/2-14	-	2	2.71	1.50	1.22	1.06	69	38	31	27	0.50	310
HA0523300	HA05233V0	HA05233E0	1/2	10.3	1/2-14	-	-	2	2.71	1.50	1.22	1.06	69	38	31	27	0.50	310
HA0533300	HA05333V0	HA05333E0	1/2	10.3	-	-	M22x150	2	2.71	1.50	1.22	1.06	69	38	31	27	0.50	310
HA0504300	HA05043V0	HA05043E0	3/4	14.2	-	3/4-14	-	2	3.50	1.89	1.57	1.38	89	48	40	35	1.27	665
HA0524300	HA05243V0	HA05243E0	3/4	14.2	3/4-14	-	-	2	3.50	1.89	1.57	1.38	89	48	40	35	1.27	665
HA0534300	HA05343V0	HA05343E0	3/4	14.2	-	-	M27x150	2	3.50	1.89	1.57	1.38	89	48	40	35	1.27	665
HA0505300	HA05053V0	HA05053E0	1	16.5	-	1-11	-	2	3.89	2.05	1.77	1.61	99	52	45	41	1.59	813
HA0525300	HA05253V0	HA05253E0	1	16.5	1-11 1/2	-	-	2	3.89	2.05	1.77	1.61	99	52	45	41	1.59	813
-	HA05063V0	HA05063E0	1 1/4	20.5	-	1 1/4-11	-	2	5.20	2.95	2.44	2.16	132	75	62	55	4.77	2,230
-	HA05073V0	HA05073E0	1 1/2	25.8	-	1 1/2-11	-	2	5.90	3.35	2.95	2.56	150	85	75	65	7.72	3,585
-	HA05093V0	HA05093E0	2	34.7	-	2-11	-	2	6.69	3.82	3.35	2.95	170	97	85	75	10.67	5,658

* Body sizes 1 1/4, 1 1/2 and 2 are supplied with FKM seals as a standard.

** Alternative end connections available upon request.

To obtain connected length of coupling add dimensions D (Fig. 2) and J (Fig. 3) together.

H5000 Series (Steel)

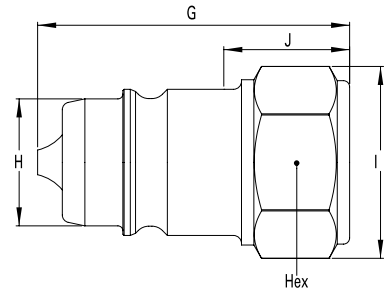

Figure 3

Plugs (Male)

Part Number	FKM	EPDM	Nominal Body Flow		Thread Size** (Female)			Fig.	Dimensions						Weight					
			Size	Diameter	NPT	BSPP	Metric		G	H	I	J	Hex	G	H	I	J	Hex	lbs	grams
NBR*			(in)	(mm)					(in)	(in)	(in)	(in)	(in)	(mm)	(mm)	(mm)	(mm)	(mm)		
HA0500200	HA05002V0	HA05002E0	1/8	3.8	-	1/8-28	-	3	1.10	0.43	0.72	0.39	0.63	28	11	18.4	10	16	0.05	23
HA0520200	HA05202V0	HA05202E0	1/8	3.8	-	1/8-27	-	3	1.10	0.43	0.72	0.39	0.63	28	11	18.4	10	16	0.05	23
HA0530200	HA05302V0	HA05302E0	1/8	3.8	-	-	M10x100	3	1.10	0.43	0.72	0.39	0.63	28	11	18.4	10	16	0.05	23
HA0501200	HA05012V0	HA05012E0	1/4	5.7	-	1/4-19	-	3	1.38	0.56	0.86	0.55	0.75	35	14.2	21.8	14	19	0.08	37
HA0521200	HA05212V0	HA05212E0	1/4	5.7	-	1/4-18	-	3	1.38	0.56	0.86	0.55	0.75	35	14.2	21.8	14	19	0.08	37
HA0531200	HA05312V0	HA05312E0	1/4	5.7	-	-	M14x150	3	1.38	0.56	0.86	0.55	0.75	35	14.2	21.8	14	19	0.08	37
HA0502200	HA05022V0	HA05022E0	3/8	7.6	-	3/8-19	-	3	1.65	0.75	1.04	0.7	0.90	42	19	26.4	18	23	0.15	70
HA0522200	HA05222V0	HA05222E0	3/8	7.6	-	3/8-18	-	3	1.65	0.75	1.04	0.7	0.90	42	19	26.4	18	23	0.15	70
HA0532200	HA05322V0	HA05322E0	3/8	7.6	-	-	M18x150	3	1.65	0.75	1.04	0.7	0.90	42	19	26.4	18	23	0.15	70
HA0503200	HA05032V0	HA05032E0	1/2	10.3	-	1/2-14	-	3	1.97	0.81	1.22	0.94	1.06	50	20.6	31	24	27	0.20	92
HA0523200	HA05232V0	HA05232E0	1/2	10.3	-	1/2-14	-	3	1.97	0.81	1.22	0.94	1.06	50	20.6	31	24	27	0.20	92
HA0533200	HA05332V0	HA05332E0	1/2	10.3	-	-	M22x150	3	1.97	0.81	1.22	0.94	1.06	50	20.6	31	24	27	0.20	92
HA0504200	HA05042V0	HA05042E0	3/4	14.2	-	3/4-14	-	3	2.48	1.10	1.58	1.10	1.38	63	27.9	40.2	28	35	0.48	217
HA0524200	HA05242V0	HA05242E0	3/4	14.2	-	3/4-14	-	3	2.48	1.10	1.58	1.10	1.38	63	27.9	40.2	28	35	0.48	217
HA0534200	HA05342V0	HA05342E0	3/4	14.2	-	-	M27x150	3	2.48	1.10	1.58	1.10	1.38	63	27.9	40.2	28	35	0.48	217
HA0505200	HA05052V0	HA05052E0	1	16.5	-	1-11	-	3	2.79	1.27	1.87	1.22	1.61	71	32.4	47.5	31	41	0.63	287
HA0525200	HA05252V0	HA05252E0	1	16.5	-	1-11 1/2	-	3	2.79	1.27	1.87	1.22	1.61	71	32.4	47.5	31	41	0.63	287
-	HA05062V0	HA05062E0	1 1/4	20.5	-	1 1/4-11	-	3	3.82	1.85	2.49	1.89	2.16	97	46.9	63.2	48	55	1.98	900
-	HA05072V0	HA05072E0	1 1/2	25.8	-	1 1/2-11	-	3	4.29	2.20	2.94	2.04	2.56	109	56	74.7	52	65	3.30	1500
-	HA05092V0	HA05092E0	2	34.7	-	2-11	-	3	4.76	2.56	3.30	1.97	2.95	121	65	84	50	75	4.06	1840

* Body sizes 1 1/4, 1 1/2 and 2 are supplied with FKM seals as a standard.

** Alternative end connections available upon request.

To obtain connected length of coupling add dimensions A (Fig. 1) and J (Fig. 3) together for standard version ; add dimensions D (Fig. 2) and J (Fig. 3) together for sleeve lock version.

Dust Plugs and Dust Caps

Body Size (in)	Socket Dust Plug Part Number	Plug Dust Cap Part Number
	Anodized Aluminum	Anodized Aluminum
1/8	HD0510100	HD0510200
1/4	HD0511100	HD0511200
3/8	HD0512100	HD0512200
1/2	HD0513100	HD0513200
3/4	HD0514100	HD0514200
1	HD0515100	HD0515200
1 1/4	HD0516100	HD0516200
1 1/2	HD0517100	HD0517200
2	HD0519100	HD0519200

Socket Dust Plug



Plug Dust Cap

FLUID TRANSFER
AND HYDRAULIC

PNEUMATIC

SPECIAL APPLICATIONS

DIAGNOSTIC

AGRICULTURE

REFRIGERANT

H5000 Series (Brass)



Eaton's H5000 Series brass quick disconnect coupling is a pull to connect double shut-off coupling. It is a general purpose industrial quick disconnect coupling with the original Eaton's Gromelle™ profile. Mainly used in fluid transfer applications where stainless steel is not a requirement, it offers a good alternative for corrosion resistance.

Product Features

- Proprietary profile
- Pull-to-connect with double shut-off valving
- Ball-locking
- Pressure performance
- Optional safety sleeve lock prevents accidental disconnections
- Optional dust caps and plugs (made of anodized aluminum)
- Standard body material: Nickel-plated brass
- Standard seal material: NBR, FKM, EPDM

European Pressure Equipment Directive

Couplings with nominal diameters up to and including 25 mm are designed and manufactured under Article 3.3 of the European Pressure Equipment Directive 97/23 EC. Couplings with nominal diameters greater than 25 mm are designed and manufactured under Article 3.3 of the European Pressure Equipment Directive 97/23 EC. They should not be used to convey gases in Group 1 (hazardous).

Group 1 = Hazardous media / Group 2 = Other media

Physical Characteristics

Body Size (in)	Nominal Flow Diameter* (mm)	Max. Operating Pressure**				Rated Flow***		Fluid Loss (ml-cc)
		Non hazardous liquids & gases Group 2 (bar)	Non hazardous liquids & gases Group 2 (psi)	Non Hazardous liquids & gases Group 2 (bar)	Non Hazardous liquids & gases Group 2 (psi)	(lpm)	(gpm)	
1/8	3.8	300	4,350	300	4,350	6.1	1.61	0.4
1/4	5.7	230	3,335	230	3,335	11.6	3.06	1
3/8	7.6	175	2,535	175	2,535	16.7	4.41	2
1/2	10.3	150	2,175	150	2,175	25.5	6.74	2.5
3/4	14.2	125	1,810	125	1,810	55	14.53	5.5
1	16.5	100	1,450	100	1,450	87	22.98	9
1 1/4	20.5	70	1,015	70	1,015	140	36.98	23
1 1/2	25.8	50	725	50	725	208	54.95	36
2	34.7	40	290	28	406	357	94.3	70

* Nominal diameters over 25 mm should not be used to convey gases in Group 1 PED 2014/68/EU

** For pulsating pressures when disconnected apply a multiplier of 0.5

*** Indicated values refer to a 1 bar/14.5 psi pressure drop.

Flow Data

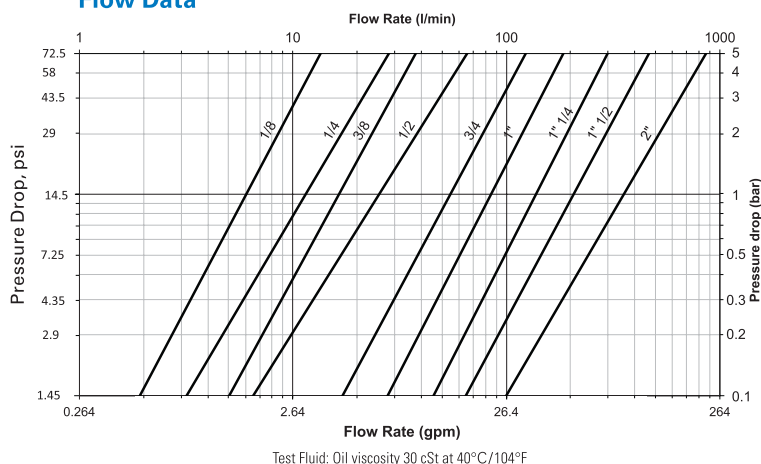

Applications & Markets

- Automobile
- Agriculture
- Construction
- Oil and Gas
- Railway
- Aeronautics
- Food processing
- Iron and Steel Industry
- Electronics
- Laboratories
- General hydraulic applications

Seal Elastomer Data*

Seal Elastomer	Max. Operation Temperature Range
NBR (Nitrile)	-20°C +100°C/-4°F +212°F
FKM	-20°C +200°C/-4°F +392°F
EPDM (Ethylene-Propylene)**	-40°C +150°C/-40°F +302°F

* For reference only, based on Eaton recommended temperatures.

** In accordance with NF L 17-241 or NAS 1613 rev. 5

Contact Eaton technical support for further information on fluid compatibility.

H5000 Series (Brass)

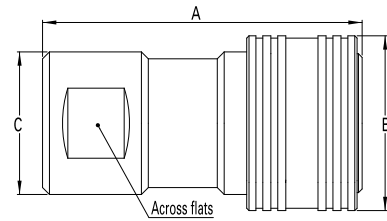

Figure 1

Sockets (Female)

Part Number			Body Size	Nominal Flow Diameter	Thread Size* (Female)	Fig.	Dimensions								Weight	
NBR	FKM	EPDM					(in)	(mm)	BSPP	A (in)	B (in)	C (in)	Across flats (in)	A (mm)	B (mm)	C (mm)
HL0500100	HL05001V0	HL05001E0	¼	3.8	¼-28	1	1.65	0.94	0.83	0.63	42	24	21	16	0.21	97
HL0501100	HL05011V0	HL05011E0	¼	5.7	¼-19	1	1.97	1.10	0.94	0.75	50	28	24	19	0.30	134
HL0502100	HL05021V0	HL05021E0	⅜	7.6	⅜-19	1	2.32	1.34	1.10	0.90	59	34	28	23	0.48	217
HL0503100	HL05031V0	HL05031E0	½	10.3	½-14	1	2.71	1.50	1.22	1.06	69	38	31	27	0.55	249
HL0504100	HL05041V0	HL05041E0	¾	14.2	¾-14	1	3.50	1.89	1.57	1.38	89	48	40	35	1.40	635
HL0505100	HL05051V0	HL05051E0	1	16.5	1-11	1	3.89	2.05	1.77	1.61	99	52	45	41	1.75	792
HL0506100	HL05061V0	HL05061E0	1¼	20.5	1¼-11	1	5.20	2.95	2.44	2.16	132	75	62	55	5.25	2,382
HL0507100	HL05071V0	HL05071E0	1½	25.8	1½-11	1	5.90	3.35	2.95	2.56	150	85	75	65	8.49	3,850
HL0509100	HL05091V0	HL05091E0	2	34.7	2-11	1	6.69	3.82	3.35	2.95	170	97	85	75	11.74	5,324

* Alternative end connections available upon request.

To obtain connected length of coupling add dimensions A (Fig. 1) and J (Fig. 3) together.

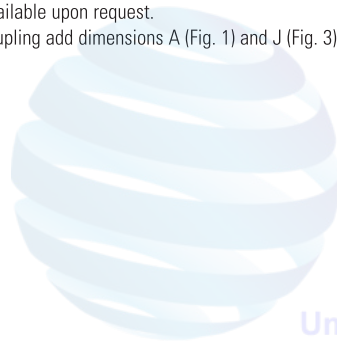

King®
Comercial
Um nome carregado de soluções

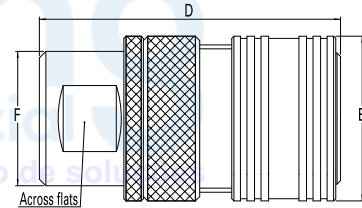

Figure 2

Sockets with Sleeve Lock (Female)

Part Number			Body Size	Nominal Flow Diameter	Thread Size* (Female)	Fig.	Dimensions								Weight	
NBR	FKM	EPDM					(in)	(mm)	BSPP	D (in)	E (in)	F (in)	Across flats (in)	D (mm)	E (mm)	F (mm)
HL0500300	HL05003V0	HL05003E0	¼	3.8	¼-28	2	1.65	0.94	0.83	0.63	42	24	21	16	0.22	100
HL0501300	HL05013V0	HL05013E0	¼	5.7	¼-19	2	1.97	1.10	0.94	0.75	50	28	24	19	0.33	148
HL0502300	HL05023V0	HL05023E0	⅜	7.6	⅜-19	2	2.32	1.34	1.10	0.90	59	34	28	23	0.55	248
HL0503300	HL05033V0	HL05033E0	½	10.3	½-14	2	2.71	1.50	1.22	1.06	69	38	31	27	0.75	341
HL0504300	HL05043V0	HL05043E0	¾	14.2	¾-14	2	3.50	1.89	1.57	1.38	89	48	40	35	1.61	732
HL0505300	HL05053V0	HL05053E0	1	16.5	1-11	2	3.89	2.05	1.77	1.61	99	52	45	41	1.97	894
HL0506300	HL05063V0	HL05063E0	1¼	20.5	1¼-11	2	5.20	2.95	2.44	2.16	132	75	62	55	5.41	2,453
HL0507300	HL05073V0	HL05073E0	1½	25.8	1½-11	2	5.90	3.35	2.95	2.56	150	85	75	65	8.69	3,944
HL0509300	HL05093V0	HL05093E0	2	34.7	2-11	2	6.69	3.82	3.35	2.95	170	97	85	75	13.72	6,224

* Alternative end connections available upon request.

To obtain connected length of coupling add dimensions D (Fig. 2) and J (Fig. 3) together.

H5000 Series (Brass)

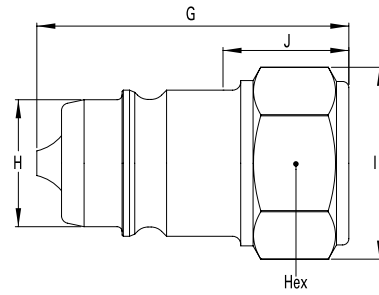

Figure 3

Plugs (Male)

Part Number			Body Size (in)	Nominal Flow Diameter (mm)	Thread Size** (Female)	Fig.	Dimensions										Weight	
NBR*	FKM	EPDM					G (in)	H (in)	I (in)	J (in)	Hex (in)	G (mm)	H (mm)	I (mm)	J (mm)	Hex (mm)	lbs	grams
HL0500200	HL05002V0	HL05002E0	1/8	3.8	1/8-28	3	1.1	0.43	0.72	0.39	0.63	28	11	18.4	10	16	0.06	26
HL0501200	HL05012V0	HL05012E0	1/4	5.7	1/4-19	3	1.38	0.56	0.86	0.55	0.75	35	14.2	21.8	14	19	0.09	41
HL0502200	HL05022V0	HL05022E0	3/8	7.6	3/8-19	3	1.65	0.75	1.04	0.70	0.90	42	19	26.4	18	23	0.17	77
HL0503200	HL05032V0	HL05032E0	1/2	10.3	1/2-14	3	1.97	0.81	1.22	0.94	1.06	50	20.6	31	24	27	0.22	101
HL0504200	HL05042V0	HL05042E0	3/4	14.2	3/4-14	3	2.48	1.10	1.58	1.10	1.38	63	27.9	40.2	28	35	0.53	239
HL0505200	HL05052V0	HL05052E0	1	16.5	1-11	3	2.79	1.27	1.87	1.22	1.61	71	32.4	47.5	31	41	0.70	316
-	HL05062V0	HL05062E0	1 1/4	20.5	1 1/4-11	3	3.82	1.85	2.49	1.89	2.16	97	46.9	63.2	48	55	2.18	990
-	HL05072V0	HL05072E0	1 1/2	25.8	1 1/2-11	3	4.29	2.20	2.94	2.04	2.56	109	56	74.7	52	65	3.64	1650
-	HL05092V0	HL05092E0	2	34.7	2-11	3	4.76	2.56	3.30	1.97	2.95	121	65	84	50	75	4.46	2024

* Body sizes 1 1/4, 1 1/2 and 2 are supplied with FKM seals as a standard.

**Alternative end connections available upon request.

To obtain connected length of coupling add dimensions A (Fig. 1) and J (Fig. 3) together for standard version; add dimensions D (Fig. 2) and J (Fig. 3) together for sleeve lock version

Dust Plugs and Dust Caps

Body Size (in)	Socket Dust Plug Part Number		Plug Dust Cap Part Number	
	Anodized Aluminum		Anodized Aluminum	
1/8	HD0510100	HD0510200	HD0510200	HD0510200
1/4	HD0511100	HD0511200	HD0511200	HD0511200
3/8	HD0512100	HD0512200	HD0512200	HD0512200
1/2	HD0513100	HD0513200	HD0513200	HD0513200
3/4	HD0514100	HD0514200	HD0514200	HD0514200
1	HD0515100	HD0515200	HD0515200	HD0515200
1 1/4	HD0516100	HD0516200	HD0516200	HD0516200
1 1/2	HD0517100	HD0517200	HD0517200	HD0517200
2	HD0519100	HD0519200	HD0519200	HD0519200



H5000 Series (Stainless Steel)



Eaton's H5000 Series stainless steel quick disconnect coupling is a pull to connect double shut-off coupling. It is a general purpose industrial coupling with the original Eaton's Gromelle™ profile. It is mainly used in fluid transfer applications and provides excellent corrosion resistance.

Product Features

- Proprietary profile
- Pull-to-connect with double shut-off valving
- Ball-locking
- Optional safety sleeve lock prevents accidental disconnections
- Optional dust caps and plugs (made of anodized aluminum)
- Pressure performance
- Standard body material: AISI 316L Stainless steel
- Standard seal material: FKM, EPDM

European Pressure Equipment Directive

Couplings with nominal diameters up to and including 25 mm are designed and manufactured under Article 3.3 of the European Pressure Equipment Directive 97/23 EC. Couplings with nominal diameters greater than 25 mm are designed and manufactured in accordance with the stipulations of Module A of the European Pressure Equipment Directive 97/23 EC. They should not be used to convey unstable gases.

Physical Characteristics

Body Size (in)	Nominal Flow Diameter (mm)	Max. Operating Pressure*				Rated Flow**		Fluid Loss ml-cc.
		Non hazardous liquids & gases Group 2		Hazardous liquids & gases Group 2		(lpm)	(gpm)	
1/8	3.8	300	4,350	300	4,350	6.1	1.61	0.4
1/4	5.7	230	3,335	230	3,335	11.6	3.06	1
3/8	7.6	175	2,535	175	2,535	16.7	4.41	2
1/2	10.3	150	2,175	150	2,175	25.5	6.74	2.5
3/4	14.2	125	1,810	125	1,810	55	14.53	5.5
1	16.5	100	1,450	100	1,450	87	22.98	9
1 1/4	20.5	100	1,450	100	1,450	140	36.98	23
1 1/2	25.8	75	1,085	38	550	208	54.95	36
2	34.7	40	580	28	405	357	94.30	70

* For pulsating pressures when disconnected apply a multiplier of 0.5

** Indicated values refer to a 1 bar/14.5 psi pressure drop.

Applications & Markets

- Automobile
- Agriculture
- Construction
- Oil and Gas
- Railway
- Aeronautics
- Food processing
- Iron and Steel Industry
- Electronics
- Laboratories
- General hydraulic applications

Flow Data

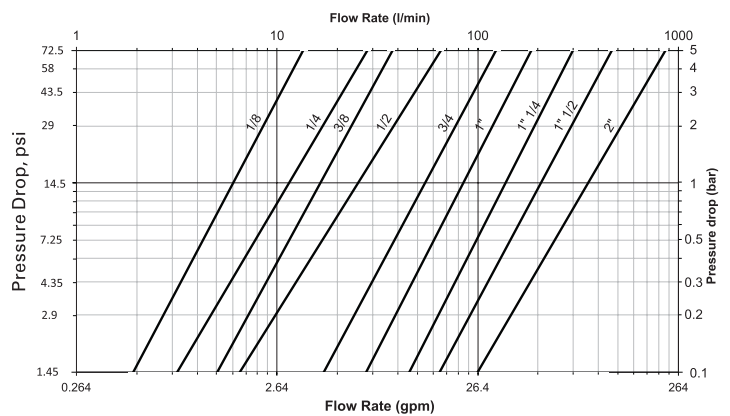

Seal Elastomer Data*

Seal Elastomer	Max. Operation Temperature Range
FKM	-20°C +200°C/-4°F +392°F
EPDM (Ethylene-Propylene)**	-40°C +150°C/-40°F +302°F

* For reference only, based on Eaton recommended temperatures.

** In accordance with NF L 17-241 or NAS 1613 rev. 5

Contact Eaton technical support for further information on fluid compatibility.

H5000 Series (Stainless Steel)

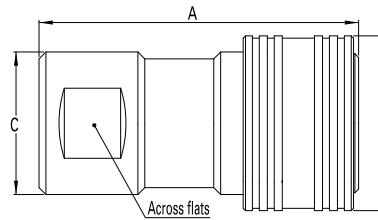

Figure 1

Sockets (Female)

Part Number		Body Size	Nominal Flow Diameter	Thread Size* (Female)		Fig.	Dimensions							Weight		
FKM	EPDM	(in)	(mm)	NPT	BSPP		A (in)	B (in)	C (in)	Across flats (in)	A (mm)	B (mm)	C (mm)	Across flats (mm)	lbs	grams
HZ05001V0	HZ05001E0	1/8	3.8	-	1/8-28	1	1.65	0.94	0.83	0.63	42	24	21	16	0.19	88
HZ05201V0	HZ05201E0	1/8	3.8	1/8-27	-	1	1.65	0.94	0.83	0.63	42	24	21	16	0.19	88
HZ05011V0	HZ05011E0	1/4	5.7	-	1/4-19	1	1.97	1.10	0.94	0.75	50	28	24	19	0.27	122
HZ05211V0	HZ05211E0	1/4	5.7	1/4-18	-	1	1.97	1.10	0.94	0.75	50	28	24	19	0.27	122
HZ05021V0	HZ05021E0	3/8	7.6	-	3/8-19	1	2.32	1.34	1.10	0.90	59	34	28	23	0.43	197
HZ05221V0	HZ05221E0	3/8	7.6	3/8-18	-	1	2.32	1.34	1.10	0.90	59	34	28	23	0.43	197
HZ05031V0	HZ05031E0	1/2	10.3	-	1/2-14	1	2.71	1.50	1.22	1.06	69	38	31	27	0.50	226
HZ05231V0	HZ05231E0	1/2	10.3	1/2-14	-	1	2.71	1.50	1.22	1.06	69	38	31	27	0.50	226
HZ05041V0	HZ05041E0	3/4	14.2	-	3/4-14	1	3.50	1.89	1.57	1.38	89	48	40	35	1.27	577
HZ05241V0	HZ05241E0	3/4	14.2	3/4-14	-	1	3.50	1.89	1.57	1.38	89	48	40	35	1.27	577
HZ05051V0	HZ05051E0	1	16.5	-	1-11	1	3.89	2.05	1.77	1.61	99	52	45	41	1.59	720
HZ05251V0	HZ05251E0	1	16.5	1-11 1/2	-	1	3.89	2.05	1.77	1.61	99	52	45	41	1.59	720
HZ05061V0	HZ05061E0	1 1/4	20.5	-	1 1/4-11	1	5.20	2.95	2.44	2.16	132	75	62	55	4.77	2,165
HZ05071V0	HZ05071E0	1 1/2	25.8	-	1 1/2-11	1	5.90	3.35	2.95	2.56	150	85	75	65	7.72	3,500
HZ05091V0	HZ05091E0	2	34.7	-	2-11	1	6.69	3.82	3.35	2.95	170	97	85	75	10.67	4,840

* Alternative end connections available upon request.
To obtain connected length of coupling add dimensions A (Fig. 1) and J (Fig. 3) together.

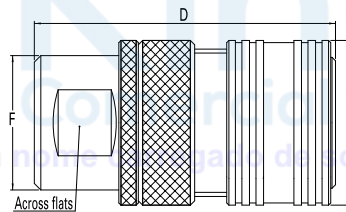

Figure 2

Sockets with Sleeve Lock (Female)

Part Number		Body Size	Nominal Flow Diameter	Thread Size* (Female)	Fig.	Dimensions							Weight		
FKM	EPDM	(in)	(mm)	BSPP		D (in)	E (in)	F (in)	Across flats (in)	D (mm)	E (mm)	F (mm)	Across flats (mm)	lbs	grams
HZ05003V0	HZ05003E0	1/8	3.8	1/8-28	2	1.65	0.94	0.83	0.63	42	24	21	16	0.19	91
HZ05013V0	HZ05013E0	1/4	5.7	1/4-19	2	1.97	1.10	0.94	0.75	50	28	24	19	0.27	134
HZ05023V0	HZ05023E0	3/8	7.6	3/8-19	2	2.32	1.34	1.10	0.90	59	34	28	23	0.43	225
HZ05033V0	HZ05033E0	1/2	10.3	1/2-14	2	2.71	1.50	1.22	1.06	69	38	31	27	0.50	310
HZ05043V0	HZ05043E0	3/4	14.2	3/4-14	2	3.50	1.89	1.57	1.38	89	48	40	35	1.27	665
HZ05053V0	HZ05053E0	1	16.5	1-11	2	3.89	2.05	1.77	1.61	99	52	45	41	1.59	813
HZ05063V0	HZ05063E0	1 1/4	20.5	1 1/4-11	2	5.20	2.95	2.44	2.16	132	75	62	55	4.77	2,230
HZ05073V0	HZ05073E0	1 1/2	25.8	1 1/2-11	2	5.90	3.35	2.95	2.56	150	85	75	65	7.72	3,585
HZ05093V0	HZ05093E0	2	34.7	2-11	2	6.69	3.82	3.35	2.95	170	97	85	75	10.67	5,658

* Alternative end connections available upon request.
To obtain connected length of coupling add dimensions D (Fig. 2) and J (Fig. 3) together.

H5000 Series (Stainless Steel)

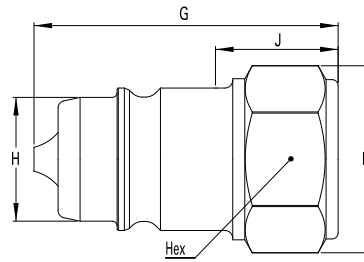

Figure 3

Plugs (Male)

Part Number	FKM	EPDM	Body Size (in)	Nominal Flow Diameter (mm)	Thread Size* (Female)		Fig.	Dimensions										Weight	
					NPT	BSPP		G (in)	H (in)	I (in)	J (in)	Hex (in)	G (mm)	H (mm)	I (mm)	J (mm)	Hex (mm)	lbs	grams
HZ05002V0		HZ05002E0	1/8	3.8	-	1/8-28	3	1.10	0.43	0.72	0.39	0.63	28	11	18.4	10	16	0.05	23
HZ05202V0		HZ05202E0	1/8	3.8	1/8-27	-	3	1.10	0.43	0.72	0.39	0.63	28	11	18.4	10	16	0.05	23
HZ05012V0		HZ05012E0	1/4	5.7	-	1/4-19	3	1.38	0.56	0.86	0.55	0.75	35	14.2	21.8	14	19	0.08	37
HZ05212V0		HZ05212E0	1/4	5.7	1/4-18	-	3	1.38	0.56	0.86	0.55	0.75	35	14.2	21.8	14	19	0.08	37
HZ05022V0		HZ05022E0	3/8	7.6	-	3/8-19	3	1.65	0.75	1.04	0.70	0.90	42	19	26.4	18	23	0.15	70
HZ05222V0		HZ05222E0	3/8	7.6	3/8-18	-	3	1.65	0.75	1.04	0.70	0.90	42	19	26.4	18	23	0.15	70
HZ05032V0		HZ05032E0	1/2	10.3	-	1/2-14	3	1.97	0.81	1.22	0.94	1.06	50	20.6	31	24	27	0.20	92
HZ05232V0		HZ05232E0	1/2	10.3	1/2-14	-	3	1.97	0.81	1.22	0.94	1.06	50	20.6	31	24	27	0.20	92
HZ05042V0		HZ05042E0	3/4	14.2	-	3/4-14	3	2.48	1.10	1.58	1.10	1.38	63	27.9	40.2	28	35	0.48	217
HZ05242V0		HZ05242E0	3/4	14.2	3/4-14	-	3	2.48	1.10	1.58	1.10	1.38	63	27.9	40.2	28	35	0.48	217
HZ05052V0		HZ05052E0	1	16.5	-	1-11	3	2.79	1.27	1.87	1.22	1.61	71	32.4	47.5	31	41	0.63	287
HZ05252V0		HZ05252E0	1	16.5	1-11 1/2	-	3	2.79	1.27	1.87	1.22	1.61	71	32.4	47.5	31	41	0.63	287
HZ05062V0		HZ05062E0	1 1/4	20.5	-	1 1/4-11	3	3.82	1.85	2.49	1.89	2.16	97	46.9	63.2	48	55	1.98	900
HZ05072V0		HZ05072E0	1 1/2	25.8	-	1 1/2-11	3	4.29	2.20	2.94	2.04	2.56	109	56	74.7	52	65	3.30	1500
HZ05092V0		HZ05092E0	2	34.7	-	2-11	3	4.76	2.56	3.30	1.97	2.95	121	65	84	50	75	4.06	1840

* Alternative end connections available upon request.

To obtain connected length of coupling add dimensions A (Fig. 1) and J (Fig. 3) together for standard version; add Dimensions D (Fig. 2) and J (Fig. 3) together for sleeve lock version

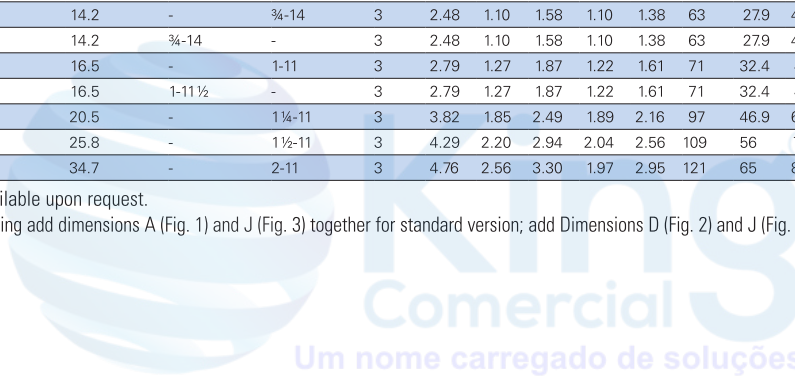

Dust Plugs and Dust Caps

Body Size (in)	Socket Dust Plug Part Number Anodized Aluminum	Plug Dust Cap Part Number Anodized Aluminum
1/8	HD0510100	HD0510200
1/4	HD0511100	HD0511200
3/8	HD0512100	HD0512200
1/2	HD0513100	HD0513200
3/4	HD0514100	HD0514200
1	HD0515100	HD0515200
1 1/4	HD0516100	HD0516200
1 1/2	HD0517100	HD0517200
2	HD0519100	HD0519200



FLUID TRANSFER AND HYDRAULIC

PNEUMATIC

SPECIAL APPLICATIONS

DIAGNOSTIC

AGRICULTURE

REFRIGERANT

FF Series (Steel) ISO 16028 Interchange



Eaton's FF Series flat face is specifically designed for those applications where quick and easy connections and no-spill performance are essential. The FF Series is ideal for use when global interchangeability with other manufacturers is important and is available in sizes from 1/4" through 2" to best meet your specific size requirements.

Product Features

- Meets or exceeds the ISO 16028 standard
- Push-to-connect
- Standard sleeve lock prevents accidental disconnection
- Color identification rings available to help prevent crossing of lines
- Standard Material: High-resistant carbon steel with Guardian Seal™ plating, a whole new level of corrosion resistance with minimum 720 hours RR protection
- Guardian Seal™ plating
 - Nickel-free
 - Solvent-free
 - Meets Global RoHS, ELV and REACH requirements
- Standard Seal Material: NBR+AU
- Available seal options: NBR+AU, FKM, EPDM, HNBR (upon request)

Physical Characteristics

ISO Size* (mm)	Coupling Size (in)	Maximum Operating Pressure				Minimum Burst Pressure				Rated Flow**		Fluid Loss ml-cc.	Air Inclusion ml-cc.	Force to Connect					
		Connected*** (bar)	Plug/ Male Half (psi)	Socket/ Female Half (bar)	Plug/ Male Half (psi)	Connected (bar)	Plug/ Male Half (psi)	Socket/ Female Half (bar)	Plug/ Male Half (psi)	(lpm)	(gpm)			N	Lbs				
6.3	1/4	400	5,800	400	5,800	1,400	20,300	1,400	20,300	1,400	20,300	18	4.8	0.004	0.007	80	18.0		
10.0	3/8	400	5,800	400	5,800	1,400	20,300	1,400	20,300	1,400	20,300	40	10.6	0.006	0.010	140	31.5		
12.5	1/2	400	5,800	400	5,800	1,400	20,300	1,400	20,300	1,400	20,300	77	20.3	0.012	0.013	195	43.8		
16.0	5/8	400	5,800	400	5,800	1,400	20,300	1,400	20,300	1,400	20,300	82	21.7	0.016	0.030	205	46.1		
19.0	3/4	400	5,800	400	5,800	1,300	18,850	1,300	18,850	1,400	20,300	114	30.1	0.034	0.015	215	48.3		
25.0	1	400	5,800	400	5,800	1,260	18,270	1,260	18,270	1,260	18,270	184	48.6	0.032	0.033	260	58.5		
-	1 1/4	300	4,350	300	4,350	900	13,050	900	13,050	900	13,050	260	68.7	0.170	0.053	200	45.0		
-	1 1/2	300	4,350	300	4,350	270	3,915	900	13,050	900	13,050	810	11,745	450	118.9	0.265	0.445	385	86.6
-	2"	300	4,350	300	4,350	225	3,260	900	13,050	900	13,050	675	9,790	700	184.9	0.390	0.260	375	84.3

* The ISO size corresponds to the internal diameter of the hose or the external diameter of the rigid tube (as defined in ISO 4397 Standard)
 ** Indicated values refer to a 1 bar/14.5 psi pressure drop
 *** 400 bar for static, steady or non-pulsed applications, 350 bar for ISO pressure rating for dynamic applications with moderate hydraulic shock

Flow Data

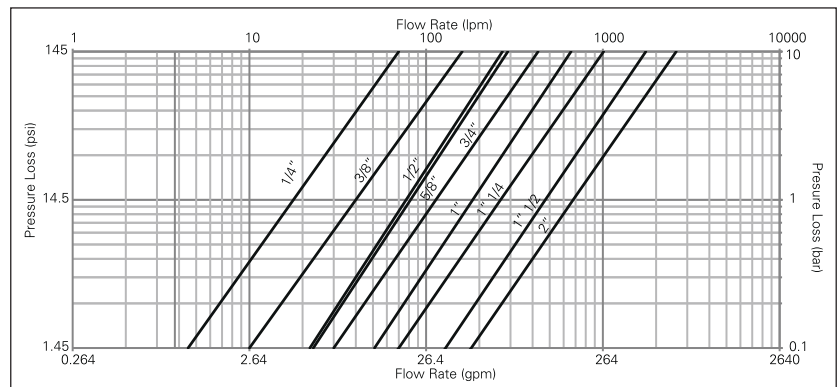

Applications & Markets

- Hydraulic and Fluid Transfer
- Construction equipment
- Agricultural equipment
- Utility vehicles
- On-Highway vehicles
- Stationary in-plant hydraulics and fluid transfer
- Interchangeable with HTMA couplings in the 3/8" size

Seal Elastomer Data*

Seal Elastomer	P/N Code	ISO Size (6FF, 10FF, 12FF, 16FF, 19FF and 25FF) Maximum Operation Temperature Range	Non-ISO Size (32FF, 50FF and 50FF) Maximum Operation Temperature Range
NBR (Nitrile) + AU (Polyurethane)	-	-25°C +100°C/-13°F +212°F	-25°C +100°C/-13°F +212°F
FKM	-143	-20°C +200°C/-4°F +392°F	-20°C +200°C/-4°F +392°F
EPDM (Ethylene-Propylene)	-192	-40°C +150°C/-40°F +302°F	on request
HNBR	-507	-32°C +150°C/-25°F +302°F	on request
Kalrez® 6375	-242	-20°C +275°C/-4°F +527°F	on request
Generic FFKM (Perfluorocarbon)	-503	-15°C +275°C/+5°F +527°F	on request

* For reference only, based on Eaton recommended temperatures.
 Contact Eaton technical support for further information on fluid compatibility

FF Series (Steel) ISO 16028 Interchange

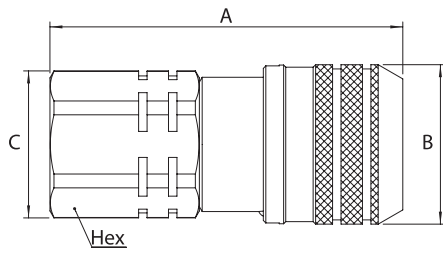
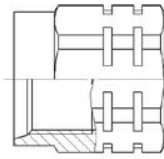
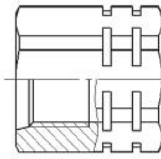

Figure 1

ISO 6149-1
15° + metric thread



SAE J 1926-1
15° + UN/UNF thread



EATON S013A
15° + BSPP thread

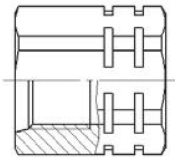

Sockets(Female)

Part Number	Body Size (in)	ISO Size (mm)	Nominal Flow Diameter		Thread Size* (Female)			Dimensions				Weight						
			(mm)	NPT	BSPP	SAE J 1926-1	Fig.	A (in)	B (in)	C (in)	Hex (in)	A (mm)	B (mm)	C (mm)	Hex (mm)	lbs	grams	
6FFS25	¼	6.3	6	¼ 18f			SAE J 1926-1	1	2.13	1.06	0.94	0.87	54	27	24	22	-	-
6FFS25BS	¼	6.3	6		¼-19			1	2.13	1.06	0.94	0.87	54	27	24	22	-	-
6FFS56UN	¼	6.3	6				¾ 18f UNF	1	2.17	1.06	0.94	0.87	55	27	24	22	-	-
10FFS37	¾	10	8.6	¾ 18f				1	2.67	1.26	1.16	1.06	67.8	32	29.5	27	-	-
10FFS37BS	¾	10	8.6		¾-19			1	2.67	1.26	1.16	1.06	67.8	32	29.5	27	-	-
10FFS50	¾	10	8.6		½ 14f			1	2.79	1.26	1.16	1.06	70.8	32	29.5	27	-	-
10FFS50BS	¾	10	8.6		½-14			1	2.79	1.26	1.16	1.06	70.8	32	29.5	27	-	-
10FFS56UN	¾	10	8.6				¾ 18f UNF	1	2.79	1.26	1.16	1.06	70.8	32	29.5	27	-	-
10FFS75UN	¾	10	8.6				¾ 16f UNF	1	2.79	1.26	1.16	1.06	70.8	32	29.5	27	-	-
10FFS87UN	¾	10	8.6				¾ 14f UNF	1	2.91	1.26	1.30	1.18	73.8	32	33	30	-	-
12FFS106UN	½	12.5	11				1 ½ 12f UN	1	3.50	1.50	1.56	1.42	89	38.2	39.5	36	-	-
12FFS50	½	12.5	11		½ 14f			1	3.27	1.50	1.56	1.42	83	38.2	39.5	36	-	-
12FFS50BS	½	12.5	11		½-14			1	3.27	1.50	1.56	1.42	83	38.2	39.5	36	-	-
12FFS75	½	12.5	11		¾ 14f			1	3.39	1.50	1.56	1.42	86	38.2	39.5	36	-	-
12FFS75BS	½	12.5	11		¾-14			1	3.39	1.50	1.56	1.42	86	38.2	39.5	36	-	-
12FFS75UN	½	12.5	11				¾ 16f UNF	1	3.27	1.50	1.56	1.42	83	38.2	39.5	36	-	-
12FFS87UN	½	12.5	11				¾ 14f UNF	1	3.39	1.50	1.56	1.42	86	38.2	39.5	36	-	-
16FFS106UN	¾	16	13				1 ½ 12f UN	1	3.50	1.66	1.56	1.42	89	42.2	39.5	36	-	-
16FFS50	¾	16	13		½ 14f			1	3.27	1.66	1.56	1.42	83	42.2	39.5	36	-	-
16FFS50BS	¾	16	13		½-14			1	3.27	1.66	1.56	1.42	83	42.2	39.5	36	-	-
16FFS75	¾	16	13		¾ 14f			1	3.39	1.66	1.56	1.42	86	42.2	39.5	36	-	-
16FFS75BS	¾	16	13		¾-14			1	3.39	1.66	1.56	1.42	86	42.2	39.5	36	-	-
16FFS75UN	¾	16	13				¾ 16f UNF	1	3.27	1.66	1.56	1.42	83	42.2	39.5	36	-	-
16FFS87UN	¾	16	13				¾ 14f UNF	1	3.39	1.66	1.56	1.42	86	42.2	39.5	36	-	-
19FFS100	¾	19	15		1 11,5f			1	3.80	1.82	1.81	1.65	96.6	46.2	46	42	-	-
19FFS100BS	¾	19	15			1-11		1	3.80	1.82	1.81	1.65	96.6	46.2	46	42	-	-
19FFS106UN	¾	19	15				1 ½ 12f UN	1	3.80	1.82	1.81	1.65	96.6	46.2	46	42	-	-
19FFS131UN	¾	19	15				1 ½ 12f UN	1	3.80	1.82	1.81	1.65	96.6	46.2	46	42	-	-
19FFS75	¾	19	15		¾ 14f			1	3.80	1.82	1.81	1.65	96.6	46.2	46	42	-	-
19FFS75BS	¾	19	15		¾-14			1	3.80	1.82	1.81	1.65	96.6	46.2	46	42	-	-
25FFS100	1	25	18		1 11,5f			1	4.07	2.17	2.36	2.17	103.5	55.2	60	55	-	-
25FFS100BS	1	25	18			1-11		1	4.07	2.17	2.36	2.17	103.5	55.2	60	55	-	-
25FFS125	1	25	18		1 ¼ 11,5f			1	4.07	2.17	2.36	2.17	103.5	55.2	60	55	-	-
25FFS125BS	1	25	18			1 ¼-11		1	4.07	2.17	2.36	2.17	103.5	55.2	60	55	-	-
25FFS131UN	1	25	18				1 ½ 12f UN	1	4.07	2.17	2.36	2.17	103.5	55.2	60	55	2.77	1260
25FFS162UN	1	25	18				1 ½ 12f UN	1	4.07	2.17	2.36	2.17	103.5	55.2	60	55	-	-
32FFS125	1 ¼		22.1		1 ¼ 11,5f			1	4.93	2.55	2.36	2.17	125.2	64.8	60	55	4.22	1915
32FFS125BS	1 ¼		22.1			1 ¼-11		1	4.93	2.55	2.36	2.17	125.2	64.8	60	55	4.18	1897
32FFS162UN	1 ¼		22.1				1 ½ 12f UN	1	4.93	2.55	2.36	2.17	125.2	64.8	60	55	4.16	1894
40FFS150	1 ½		30.1		1 ½ 11,5f			1	5.01	3.13	2.76	2.56	127.4	79.5	70	65	6.16	2796
40FFS150BS	1 ½		30.1			1 ½-11		1	5.01	3.13	2.76	2.56	127.4	79.5	70	65	6.13	2781
40FFS187UN	1 ½		30.1				1 ½ 12f UN	1	5.01	3.13	2.76	2.56	127.4	79.5	70	65	6.10	2767
50FFS200	2		39.2		2 11,5f			1	6.17	3.84	3.46	3.15	156.8	97.5	87.8	80	10.87	4931
50FFS200BS	2		39.2			2-11		1	6.17	3.84	3.46	3.15	156.8	97.5	87.8	80	10.82	4908
50FFS250UN	2		39.2				2 ½ 12f UN	1	6.17	3.84	3.46	3.15	156.8	97.5	87.8	80	10.64	4825

*Alternative end connections available upon request.

To obtain connected length of coupling, add dimensions A (Fig. 1 or Fig. 2) and G (Fig. 3 or 4) together.

FLUID TRANSFER
AND HYDRAULIC

PNEUMATIC

SPECIAL APPLICATIONS

DIAGNOSTIC

AGRICULTURE

REFRIGERANT

FF Series (Steel) ISO 16028 Interchange

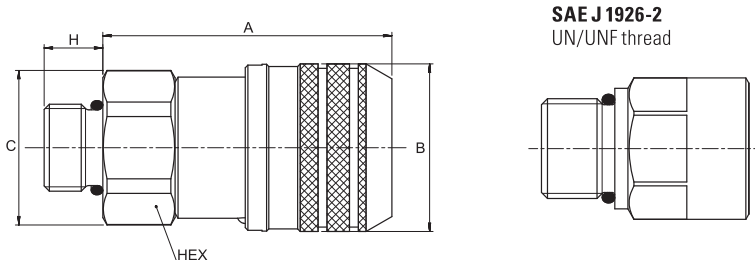

Figure 2

Sockets(Female)

Part Number	Body Size (in)	ISO Size (mm)	Nominal Flow Diameter (mm)	Dimensions											Weight		
				SAE J 1926-2	Fig.	A (in)	B (in)	C (in)	H (in.)	Hex (in)	A (mm)	B (mm)	C (mm)	H (mm)	Hex (mm)	lbs	grams
10FFS56ORM	3/8	10	8,6	3/8 18f UNF	2	2.61	1.26	1.06	0.47	0.94	66.4	32	27	12	23.8	-	-
10FFS75ORM	3/4	10	8,6	3/4 16f UNF	2	2.61	1.26	1.06	0.55	0.94	66.4	32	27	14	23.8	-	-

* Alternative end connections available upon request.

To obtain connected length of coupling, add dimensions A (Fig. 1 or Fig. 2) and G (Fig. 3 or 4) together.



FF Series (Steel) ISO 16028 Interchange

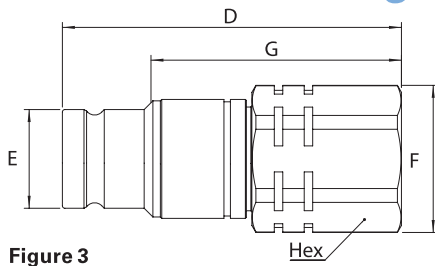
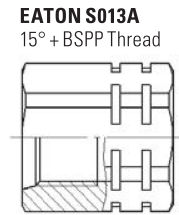
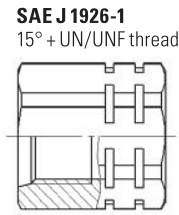
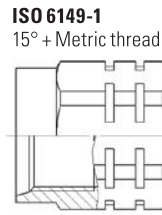

Figure 3



Plugs(Male)

Part Number	Body Size		Nominal Flow			Fig.	Dimensions										Weight	
	(in)	(mm)	(mm)	NPT	BSPP		SAE J 1926-1	D (in)	E (in)	F (in)	G (in)	Hex (in)	D (mm)	E (mm)	F (mm)	G (mm)	Hex (mm)	lbs
6FFP25	¼	6.3	6	¼ 18f		3	2.01	0.64	0.94	1.58	0.87	51	16.2	24	40.1	22	-	-
6FFP25BS	¼	6.3	6		¼-19	3	2.01	0.64	0.94	1.58	0.87	51	16.2	24	40.1	22	-	-
6FFP56UN	¼	6.3	6			3	2.05	0.64	0.94	1.62	0.87	52	16.2	24	41.1	22	-	-
10FFP37	⅜	10	8.6	⅜ 18f		3	2.56	0.78	1.16	1.96	1.06	65	19.7	29.5	49.7	27	-	-
10FFP37BS	⅜	10	8.6		⅜-19	3	2.56	0.78	1.16	1.96	1.06	65	19.7	29.5	49.7	27	-	-
10FFP50	⅜	10	8.6	½ 14f		3	2.68	0.78	1.16	2.08	1.06	68	19.7	29.5	52.7	27	-	-
10FFP50BS	⅜	10	8.6		½-14	3	2.68	0.78	1.16	2.08	1.06	68	19.7	29.5	52.7	27	-	-
10FFP56UN	⅜	10	8.6			3	2.68	0.78	1.16	2.08	1.06	68	19.7	29.5	52.7	27	-	-
10FFP75UN	⅜	10	8.6			3	2.68	0.78	1.16	2.08	1.06	68	19.7	29.5	52.7	27	-	-
10FFP87UN	⅜	10	8.6			3	2.80	0.78	1.30	2.19	1.18	71	19.7	33	55.7	30	-	-
12FFP106UN	½	12.5	11			3	2.95	0.96	1.56	2.28	1.42	75	24.5	39.5	58	36	-	-
12FFP50	½	12.5	11	½ 14f		3	2.71	0.96	1.56	2.05	1.42	69	24.5	39.5	52	36	-	-
12FFP50BS	½	12.5	11		½-14	3	2.71	0.96	1.56	2.05	1.42	69	24.5	39.5	52	36	-	-
12FFP75	½	12.5	11	¾ 14f		3	2.83	0.96	1.56	2.16	1.42	72	24.5	39.5	55	36	-	-
12FFP75BS	½	12.5	11		¾-14	3	2.83	0.96	1.56	2.16	1.42	72	24.5	39.5	55	36	-	-
12FFP75UN	½	12.5	11			3	2.71	0.96	1.56	2.05	1.42	69	24.5	39.5	52	36	-	-
12FFP87UN	½	12.5	11			3	2.83	0.96	1.56	2.16	1.42	72	24.5	39.5	55	36	-	-
16FFP106UN	⅝	16	13			3	2.95	1.06	1.56	2.28	1.42	75	27	39.5	58	36	-	-
16FFP50	⅝	16	13	½ 14f		3	2.71	1.06	1.56	2.05	1.42	69	27	39.5	52	36	-	-
16FFP50BS	⅝	16	13		½-14	3	2.71	1.06	1.56	2.05	1.42	69	27	39.5	52	36	-	-
16FFP75	⅝	16	13	¾ 14f		3	2.83	1.06	1.56	2.16	1.42	72	27	39.5	55	36	-	-
16FFP75BS	⅝	16	13		¾-14	3	2.83	1.06	1.56	2.16	1.42	72	27	39.5	55	36	-	-
16FFP75UN	⅝	16	13			3	2.71	1.06	1.56	2.05	1.42	69	27	39.5	52	36	-	-
16FFP87UN	⅝	16	13			3	2.83	1.06	1.56	2.16	1.42	72	27	39.5	55	36	-	-
19FFP100	¾	19	15	1 11,5f		3	3.69	1.18	1.81	2.84	1.65	93.8	29.9	46	72	42	-	-
19FFP100BS	¾	19	15		1-11	3	3.69	1.18	1.81	2.84	1.65	93.8	29.9	46	72	42	-	-
19FFP106UN	¾	19	15			3	3.69	1.18	1.81	2.84	1.65	93.8	29.9	46	72	42	-	-
19FFP131UN	¾	19	15			3	3.69	1.18	1.81	2.84	1.65	93.8	29.9	46	72	42	-	-
19FFP75	¾	19	15	¾ 14f		3	3.69	1.18	1.81	2.84	1.65	93.8	29.9	46	72	42	-	-
19FFP75BS	¾	19	15		¾-14	3	3.69	1.18	1.81	2.84	1.65	93.8	29.9	46	72	42	-	-
25FFP100	1	25	18	1 11,5f		3	4.12	1.42	2.36	3.22	2.17	104.6	36	60	81.7	55	-	-
25FFP100BS	1	25	18		1-11	3	4.12	1.42	2.36	3.22	2.17	104.6	36	60	81.7	55	-	-
25FFP125	1	25	18	1 ¼ 11,5f		3	4.12	1.42	2.36	3.22	2.17	104.6	36	60	81.7	55	-	-
25FFP125BS	1	25	18		1¼-11	3	4.12	1.42	2.36	3.22	2.17	104.6	36	60	81.7	55	-	-
25FFP131UN	1	25	18			3	4.12	1.42	2.36	3.22	2.17	104.6	36	60	81.7	55	2.09	962
25FFP162UN	1	25	18			3	4.12	1.42	2.36	3.22	2.17	104.6	36	60	81.7	55	-	-
32FFP125	1 ¼	-	22.1	1 ¼ 11,5f		3	4.15	1.73	2.36	3.24	2.17	105.5	44	60	82.3	55	2.63	1193
32FFP125BS	1 ¼	-	22.1		1¼-11	3	4.15	1.73	2.36	3.24	2.17	105.5	44	60	82.3	55	2.60	1177
32FFP162UN	1 ¼	-	22.1			3	4.15	1.73	2.36	3.24	2.17	105.5	44	60	82.3	55	2.59	1174
40FFP150	1 ½	-	30.1	1 ½ 11,5f		3	4.13	2.24	2.61	3.01	2.36	105	57	66.3	76.5	60	3.15	1430
40FFP150BS	1 ½	-	30.1		1½-11	3	4.13	2.24	2.61	3.01	2.36	105	57	66.3	76.5	60	3.12	1417
40FFP187UN	1 ½	-	30.1			3	4.13	2.24	2.61	3.01	2.36	105	57	66.3	76.5	60	3.10	1406
50FFP200	2	-	39.2	2 11,5f		3	5.31	2.87	3.29	3.80	2.95	135	73	83.5	96.6	75	6.01	2725
50FFP200BS	2	-	39.2		2-11	3	5.31	2.87	3.29	3.80	2.95	135	73	83.5	96.6	75	5.97	2706
50FFP250UN	2	-	39.2			3	5.31	2.87	3.29	3.80	2.95	135	73	83.5	96.6	75	5.78	2623

*Alternative end connections available upon request.

To obtain connected length of coupling, add dimensions A (Fig. 1 or Fig. 2) and G (Fig. 3 or 4) together.

FLUID TRANSFER
AND HYDRAULIC

PNEUMATIC

SPECIAL APPLICATIONS

DIAGNOSTIC

AGRICULTURE

REFRIGERANT

FF Series (Steel) ISO 16028 Interchange

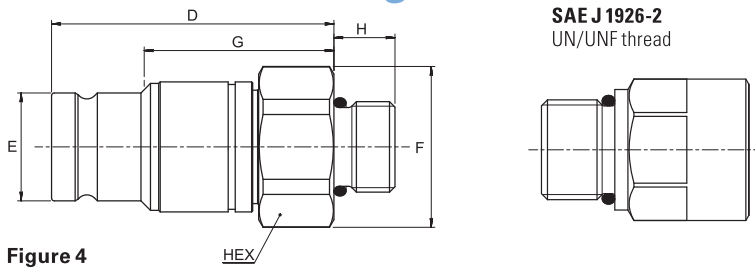

Figure 4

Plugs(Male)

Part Number	NBR+AU	FKM	EPDM	Body Size (in)	ISO Size (mm)	Nominal Flow Diameter (mm)	Dimensions											Weight			
							SAE J 1926-2	Fig.	D (in)	E (in)	F (in)	G (in.)	H (in)	Hex (in)	D (mm)	E (mm)	F (mm)	G (mm)	H (mm)	Hex (mm)	lbs
10FFP56ORM	10FFP56ORM143	10FFP56ORM192	3/8	10	8,6	3/8 18 UNF	4	2,5	0,78	1,06	1,9	0,47	0,94	63,6	19,7	27	48,3	12	23,8	0,33	150
10FFP75ORM	10FFP75ORM143	10FFP75ORM192	1/2	10	8,6	1/2 16 UNF	4	2,	0,78	1,06	1,	0,55	0,94	63,6	19,7	27	48,3	14	23,8	0,34	156

1* Alternative end connections available upon request.
To obtain connected length of coupling, add dimensions A (Fig. 1 or Fig. 2) and G (Fig. 3 or 4) together.

Socket (Female) Dust Plug

Body Size (in)	Body Size(in) with color ring	Part Number	Coupling Type	Dust Plug Material
3/8	-	SDC6FF	Socket/Female	PVC
3/8*	-	SDC10FF	Socket/Female	PVC
1/2	3/8	SDC12FF	Socket/Female	PVC
5/8	-	SDC16FF	Socket/Female	PVC
3/4	1/2	SDC19FF	Socket/Female	PVC
1	3/4	SDC25FF	Socket/Female	PVC

*Dust caps and dust plugs are offered in black.

Plug (Male) Dust Cap

Body Size (in)	Part Number	Coupling Type	Dust Plug Material
3/8	PDC6FF	Plug/Male	PVC
3/8*	PDC10FF	Plug/Male	PVC
1/2	PDC12FF	Plug/Male	PVC
5/8	PDC16FF	Plug/Male	PVC
3/4	PDC19FF	Plug/Male	PVC
1	PDC25FF	Plug/Male	PVC



Color Coding Ring Option*

Body Size (in)	ISO Size (mm)	Size	Socket/Female Ring Part Number**				Plug/Male Ring Part Number**				Tool Part Number	Tool & Rings Kit Part Number***
			Blue	Red	Yellow	Green	Blue	Red	Yellow	Green		
3/8	10	10FF	CR10FFSLB	CR10FFSRD	CR10FFSYL	CR10FFSDG	CR10FFPLB	CR10FFPRD	CR10FFPYL	CR10FFPDG	CR10FFSP93	CRKIT10FF
1/2	12.5	12FF	CR12FFSLB	CR12FFSRD	CR12FFSYL	CR12FFSDG	CR12FFPLB	CR12FFPRD	CR12FFPYL	CR12FFPDG	CR12FFSP93	CRKIT12FF
5/8	16	16FF	CR16FFSLB	CR16FFSRD	CR16FFSYL	CR16FFSDG	CR16FFPLB	CR16FFPRD	CR16FFPYL	CR16FFPDG	CR16FFSP93	CRKIT16FF
3/4	19	19FF	CR19FFSLB	CR19FFSRD	CR19FFSYL	CR19FFSDG	CR19FFPLB	CR19FFPRD	CR19FFPYL	CR19FFPDG	CR19FFSP93	CRKIT19FF

* For requests on alternative colors or installation instructions, please contact your Eaton sales representative.

** Orders must be in multiples of 10 pcs.

*** The kit consists of a tool plus 10 socket rings and 10 plug rings of each color.

MLFF Series (Stainless Steel) ISO 16028 Flat Face/Dry Break



Eaton's MLFF Series stainless steel coupling is a flat face dry break coupling used for hydraulic applications. The MLFF Series interchanges with all ISO 16028 profiles. Due to its stainless steel design, it is corrosion resistant and can handle aggressive environments.

Product Features

- Designed and manufactured under Article 3.3 of the European Pressure Equipment Directive PED 201468/EU
- Safety sleeve lock prevents accidental disconnections
- Push to connect with double shut-off valving
- Shock resistant color coding ring option available in sizes 10FF, 12FF, 16FF and 19FF to prevent accidental crossing of lines
- Resistant to aggressive environments and corrosion
- Utilize FF Series dust caps
- Standard body material: 316L Stainless steel corrosion resistant
- Alternative end connections available upon request
- Standard seal material: FKM, EPDM, NBR+AU, HNBR (upon request)

Physical Characteristics

ISO Size* (mm)	Coupling Size (in)	Maximum Operating Pressure						Minimum Burst Pressure						Rated Flow** (lpm) (gpm)	Fluid Loss ml-cc.	Air Inclusion ml-cc.	Force to Connect		
		Connected (bar) (psi)	Plug/ Male Half (bar) (psi)	Socket/ Female Half (bar) (psi)	Connected (bar) (psi)	Plug/ Male Half (bar) (psi)	Socket/ Female Half (bar) (psi)	Connected (bar) (psi)	Plug/ Male Half (bar) (psi)	Socket/ Female Half (bar) (psi)	N	Lbs							
6.3	¼	250	3,625	250	3,625	250	3,625	2,335	33,858	1,640	23,780	1,330	19,285	17	4.49	0.004	0.007	80	18.0
10	¾	250	3,625	250	3,625	250	3,625	1,672	24,244	1,664	24,128	845	12,253	29	7.66	0.006	0.010	140	31.5
12	½	250	3,625	250	3,625	250	3,625	1,679	24,346	997	14,457	993	14,399	55	14.53	0.012	0.013	195	43.8
16	¾	250	3,625	250	3,625	250	3,625	1,190	17,255	950	13,775	880	12,760	67	17.70	0.016	0.030	205	46.1
19	¾	250	3,625	250	3,625	250	3,625	1,370	19,865	882	12,789	845	12,253	105	27.74	0.034	0.015	215	48.3
25	1	250	3,625	250	3,625	250	3,625	1,690	24,505	1,000	14,500	850	12,325	177	46.76	0.032	0.033	260	58.5
25	1	250	3,625	250	3,625	250	3,625	1,690	24,505	1,000	14,500	850	12,325	177	46.76	0.032	0.033	260	58.5
-	1½	250	3,625	250	3,625	250	3,625	750	10,875	750	10,875	750	10,875	450	118.9	0.265	0.445	385	86.6
-	2"	175	2,535	175	2,535	175	2,535	525	7,610	525	7,610	525	7,610	700	184.9	0.390	0.260	375	84.3

* The ISO size corresponds to the internal diameter of the hose or the external diameter of the rigid tube (as defined in ISO 4397 Standard)

** Indicated values refer to a 1 bar/14.5 psi pressure drop

Applications & Markets

- Construction
- Agriculture
- Iron and Steel Industry
- Railway
- Oil and Gas
- Marine
- Material Handling
- General Hydraulic applications

Flow Data

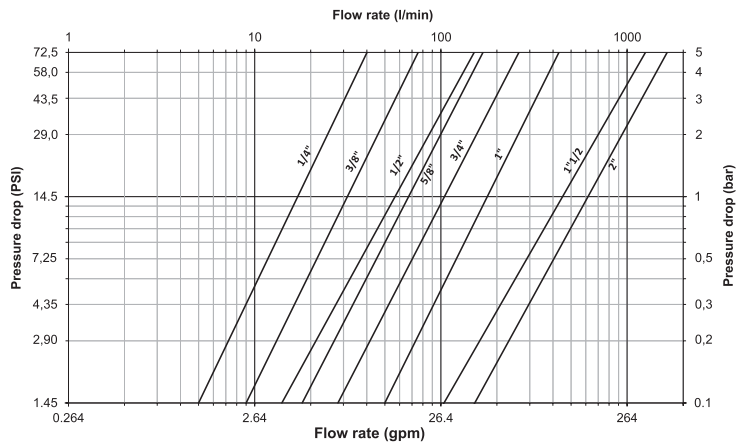

Seal Elastomer Data*

Seal Elastomer	P/N Code	ISO Size (6FF to 25FF) Maximum Operation Temperature Range	Non-ISO Size (40FF and 50FF) Maximum Operation Temperature Range
NBR (Nitrile) + AU (Polyurethane)	-	-25°C +100°C/-13°F +212°F	on request
FKM	-143	-20°C +200°C/-4°F +392°F	-20°C +200°C/-4°F +392°F
EPDM (Ethylene-Propylene)	-192	-40°C +150°C/-40°F +302°F	on request

*For reference only, based on Eaton recommended temperatures. Contact Eaton technical support for further information on fluid compatibility.

MLFF Series (Stainless Steel) ISO 16028 Flat Face/Dry Break

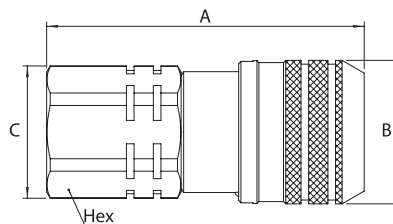

Figure 1

Sockets(Female)

Part Number	Body Size	ISO Size	Nominal Flow Diameter	Thread Size*(Female)	Dimensions	Weight												
NBR+AU	FKM	EPDM	(in)	(mm)	(mm)	NPT	BSP	Fig.	A (in)	B (in)	C (in)	Hex (in)	A (mm)	B (mm)	C (mm)	Hex (mm)	lbs	grams
ML6FFS25	ML6FFS25143	ML6FFS25192	¼	6.3	6	¼-18	-	1	2.13	1.06	0.94	0.87	54	27	24	22	0.30	135
ML6FFS25BS	ML6FFS25BS143	ML6FFS25BS192	¼	6.3	6	-	¼-19	1	2.13	1.06	0.94	0.87	54	27	24	22	0.30	135
ML10FFS37	ML10FFS37143	ML10FFS37192	⅜	10	8.6	⅜-18	-	1	2.68	1.26	1.16	1.06	68	32	29.5	27	0.54	245
ML10FFS37BS	ML10FFS37BS143	ML10FFS37BS192	⅜	10	8.6	-	⅜-19	1	2.68	1.26	1.16	1.06	68	32	29.5	27	0.54	245
ML10FFS50BS	ML10FFS50BS143	ML10FFS50BS192	⅝	10	8.6	-	½-14	1	2.80	1.26	1.16	1.06	71	32	29.5	27	0.53	240
ML12FFS50	ML12FFS50143	ML12FFS50192	½	12.5	11	½-14	-	1	3.27	1.50	1.56	1.42	83	38	39.5	36	1.03	470
ML12FFS50BS	ML12FFS50BS143	ML12FFS50BS192	½	12.5	11	-	½-14	1	3.27	1.50	1.56	1.42	83	38	39.5	36	1.03	470
ML12FFS75BS	ML12FFS75BS143	ML12FFS75BS192	½	12.5	11	-	¾-14	1	3.39	1.50	1.56	1.42	86	38	39.5	36	1.01	460
ML16FFS75	ML16FFS75143	ML16FFS75192	⅝	16	13	¾-14	-	1	3.39	1.66	1.56	1.42	86	42	39.5	36	1.21	550
ML16FFS75BS	ML16FFS75BS143	ML16FFS75BS192	⅝	16	13	-	¾-14	1	3.39	1.66	1.56	1.42	86	42	39.5	36	1.21	550
ML19FFS75	ML19FFS75143	ML19FFS75192	¾	19	15	¾-14	-	1	3.82	1.81	1.77	1.61	97	46	45	41	1.69	770
ML19FFS75BS	ML19FFS75BS143	ML19FFS75BS192	¾	19	15	-	¾-14	1	3.82	1.81	1.77	1.61	97	46	45	41	1.69	770
ML19FFS100	ML19FFS100143	ML19FFS100192	¾	19	15	1-11.5	-	1	3.80	1.82	1.77	1.61	97	46	45	41	1.56	710
ML19FFS100BS	ML19FFS100BS143	ML19FFS100BS192	¾	19	15	-	1-11	1	3.82	1.81	1.77	1.61	97	46	45	41	1.56	710
ML25FFS100BS	ML25FFS100BS143	ML25FFS100BS192	1	25	18	-	1-11	1	4.07	2.36	2.36	2.17	104	60	60	55	2.83	1290
ML25FFS125	ML25FFS125143	ML25FFS125192	1	25	18	1½-11.5	-	1	4.07	2.36	2.36	2.17	104	60	60	55	2.83	1290
ML40FFS150	ML40FFS150143	-	1 ½	-	30.1	1 ½-11.5	-	1	5.01	3.13	2.76	2.56	127.4	79.5	70	65	6.16	2767
ML40FFS150BS	ML40FFS150BS143	-	1 ½	-	30.1	-	1 ½-11	1	5.01	3.13	2.76	2.56	127.4	79.5	70	65	6.13	2752
-	ML50FFS200143	-	2	-	39.2	2-11.5	-	1	6.17	3.84	3.46	3.15	156.8	97.5	87.8	80	10.87	4883
-	ML50FFS200BS143	-	2	-	39.2	-	2-11	1	6.17	3.84	3.46	3.15	156.8	97.5	87.8	80	10.82	4861

* Alternative end connections available upon request.

To obtain connected length of coupling, add dimensions A (Fig. 1) and G (Fig. 2) together.

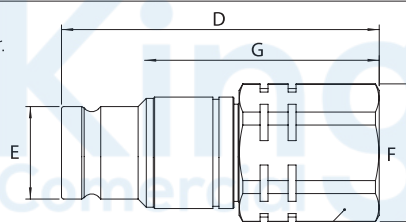

Figure 2

Plugs(Male)

Part Number	Body Size	ISO Size	Nominal Flow Diameter	Thread Size*(Female)	Dimensions	Weight														
NBR+AU	FKM	EPDM	(in)	(mm)	(mm)	NPT	BSP	Fig.	D (in)	E (in)	F (in)	G (in)	Hex (in)	D (mm)	E (mm)	F (mm)	G (mm)	Hex (mm)	lbs	grams
ML6FFP25	ML6FFP25143	ML6FFP25192	¼	6.3	6	¼-18	-	2	2.01	0.46	0.94	1.58	0.87	51	11.6	24	40.1	22	0.20	90
ML6FFP25BS	ML6FFP25BS143	ML6FFP25BS192	¼	6.3	6	-	¼-19	2	2.01	0.46	0.94	1.58	0.87	51	11.6	24	40.1	22	0.20	90
ML10FFP37	ML10FFP37143	ML10FFP37192	⅜	10	8.6	⅜-18	-	2	2.56	0.78	1.16	1.97	1.06	65	19.7	29.5	50	27	0.33	150
ML10FFP37BS	ML10FFP37BS143	ML10FFP37BS192	⅜	10	8.6	-	⅜-19	2	2.56	0.78	1.16	1.97	1.06	65	19.7	29.5	50	27	0.33	150
ML10FFP50BS	ML10FFP50BS143	ML10FFP50BS192	⅝	10	8.6	-	½-14	2	2.68	0.78	1.16	2.09	1.06	68	19.7	29.5	53	27	0.33	150
ML12FFP50	ML12FFP50143	ML12FFP50192	½	12.5	11	½-14	-	2	2.72	0.96	1.56	2.05	1.42	69	24.5	39.5	52	36	0.61	275
ML12FFP50BS	ML12FFP50BS143	ML12FFP50BS192	½	12.5	11	-	½-14	2	2.72	0.96	1.56	2.05	1.42	69	24.5	39.5	52	36	0.64	290
ML12FFP75BS	ML12FFP75BS143	ML12FFP75BS192	½	12.5	11	-	¾-14	2	2.83	0.96	1.56	2.17	1.42	72	24.5	39.5	55	36	0.61	275
ML16FFP75	ML16FFP75143	ML16FFP75192	⅝	16	13	¾-14	-	2	2.83	1.06	1.56	1.42	1.42	72	27	39.5	36	36	0.69	315
ML16FFP75BS	ML16FFP75BS143	ML16FFP75BS192	⅝	16	13	-	¾-14	2	2.83	1.06	1.56	1.42	1.42	72	27	39.5	36	36	0.69	315
ML19FFP75	ML19FFP75143	ML19FFP75192	¾	19	15	¾-14	-	2	3.70	1.18	1.77	2.83	1.61	94	29.9	45	72	41	1.28	580
ML19FFP75BS	ML19FFP75BS143	ML19FFP75BS192	¾	19	15	-	¾-14	2	3.70	1.18	1.77	2.83	1.61	94	29.9	45	72	41	1.28	580
ML19FFP100	ML19FFP100143	ML19FFP100192	¾	19	15	1-11.5	-	2	3.70	1.18	1.77	2.83	1.61	94	29.9	45	72	41	1.13	515
ML19FFP100BS	ML19FFP100BS143	ML19FFP100BS192	¾	19	15	-	1-11	2	3.70	1.18	1.77	2.83	1.61	94	29.9	45	72	41	1.12	510
ML25FFP100BS	ML25FFP100BS143	ML25FFP100BS192	1	25	18	-	1-11	2	4.12	1.42	2.36	2.17	2.17	104.6	36	60	55	55	2.37	1080
ML25FFP125	ML25FFP125143	ML25FFP125192	1	25	18	1½-11.5	-	2	4.12	1.42	2.36	2.17	2.17	104.6	36	60	55	55	2.37	1080
ML40FFP150	ML40FFP150143	-	1 ½	-	30.1	1 ½-11.5	-	2	4.13	2.24	2.61	3.01	2.36	105	57	66.3	76.5	60	3.15	1411
ML40FFP150BS	ML40FFP150BS143	-	1 ½	-	30.1	-	1 ½-11	2	4.13	2.24	2.61	3.01	2.36	105	57	66.3	76.5	60	3.12	1398
-	ML50FFP200143	-	2	-	39.2	2-11.5	-	2	5.31	2.87	3.29	3.80	2.95	135	73	83.5	96.6	75	6.01	2729
-	ML50FFP200BS143	-	2	-	39.2	-	2-11	2	5.31	2.87	3.29	3.80	2.95	135	73	83.5	96.6	75	5.97	2710

* Alternative end connections available upon request.

To obtain connected length of coupling, add dimensions A (Fig. 1) and G (Fig. 2) together.

Color Coding Ring Option*†

Body Size	ISO Size	Size	Socket/Female Ring Part Number**				Plug/Male Ring Part Number**				Tool Part Number	Tool & Rings Kit Part Number***
			Blue	Red	Yellow	Green	Blue	Red	Yellow	Green		
¼	10	ML10FF	CR10FFSLB	CR10FFSRD	CR10FFSYL	CR10FFSDG	CR10FFPLB	CR10FFPRD	CR10FFPYL	CR10FFPDG	CR10FFSP93	CRKIT10FF
½	12.5	ML12FF	CR12FFSLB	CR12FFSRD	CR12FFSYL	CR12FFSDG	CR12FFPLB	CR12FFPRD	CR12FFPYL	CR12FFPDG	CR12FFSP93	CRKIT12FF
⅝	16	ML16FF	CR16FFSLB	CR16FFSRD	CR16FFSYL	CR16FFSDG	CR16FFPLB	CR16FFPRD	CR16FFPYL	CR16FFPDG	CR16FFSP93	CRKIT16FF
¾	19	ML19FF	CR19FFSLB	CR19FFSRD	CR19FFSYL	CR19FFSDG	CR19FFPLB	CR19FFPRD	CR19FFPYL	CR19FFPDG	CR19FFSP93	CRKIT19FF

* For requests on alternative colors or installation instructions, please contact your Eaton sales representative.

** Orders must be in multiples of 10 pcs.

*** The kit consists of a tool plus 10 socket rings and 10 plug rings of each color.

† For dust caps and plugs please refer to page 38.



FFCUP Series

ISO 16028 Connect Under Pressure Flat Face Plug/Male



Eaton's FFCUP Series plug/male coupling is an ISO 16028 standard interchange. The flush face design prevents fluid loss on disconnection and air inclusion on connection guaranteeing excellent flow capability. An integrated patented system allows the FFCUP Series plug to be connected to a socket/female half coupling under 350 bar (5075 psi) residual pressure.

Product Features

- Designed and manufactured in accordance with Article 3.3 of the European Pressure Equipment Directive PED 2014/68/EU
- Meets dimensional requirements of ISO 16028
- Push to connect
- Connect under residual pressure
- Shock resistant color coding ring option available to prevent accidental crossing of lines
- Standard Material: High-resistant carbon steel with Guardian Seal™ plating, a whole new level of corrosion resistance with minimum 720 hours RR protection
- Guardian Seal™ plating
 - Nickel-free
 - Solvent-free
 - Meets Global RoHS, ELV and REACH requirements
- Alternative end connections available upon request
- Standard seal material: NBR (Nitrile) + AU (Polyurethane)
- Utilize FF Series dust caps

Physical Characteristics

Body Size	ISO Size*	Nominal Flow Diameter	Max. Operating Pressure	Min. Burst Pressure	Rated Flow**	Air Inclusion	Fluid Loss	Force to Connect				
(in)	(mm)	(mm)	(bar)	(psi)	(lpm)	(gpm)	ml-cc.	N	lbf			
3/8	10	8.6	350	5,075	1,400	20,300	29.4	7.76	0.010	0.006	350	79
1/2	12.5	11	350	5,075	1,400	20,300	46.8	12.36	0.013	0.012	270	60.7

* The ISO size corresponds to the internal diameter of the hose or the external diameter of the rigid tube (as defined in ISO 4397 Standard)

** Indicated values refer to a 1 bar/14.5 psi pressure drop

Connect Under Pressure Operating Guidelines

- The plug can be connected against 350 bar/5075 psi residual pressure to sockets/females meeting ISO 16028 standard requirements.
- Plug only is under pressure while connected.
- During the connection phase, the socket must not be under pressure.
- Disconnection under pressure is strictly forbidden.
- Connection under pressure may require a few seconds: the force to connect must be maintained during this lapse of time.

Applications & Markets

- Connection to hydraulic pumps, jacks, distributors and accessories
- Hydraulic circuits
- Material handling
- Construction
- Agriculture
- Iron and steel industry
- Railway
- Industrial plants

Flow Data

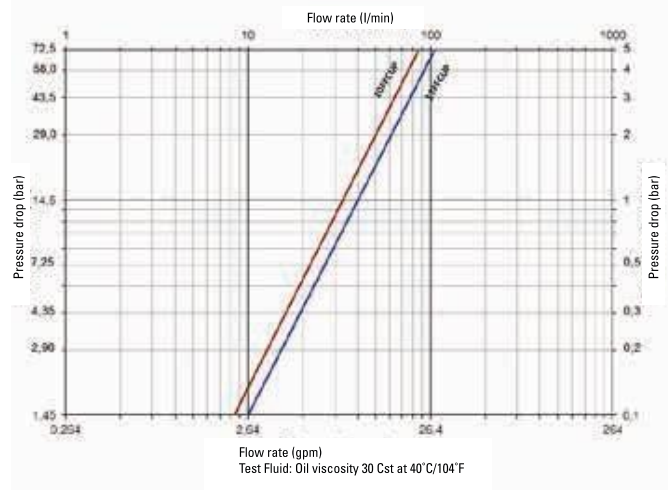

Seal Elastomer Data*

Seal Elastomer	Max. Operation Temperature Range
NBR (Nitrile) + AU (Polyurethane)	-25°C +100°C / -13°F +212°F

* For reference only, based on Eaton recommended temperatures.

Contact Eaton technical support for further information on fluid compatibility

FFCUP Series

ISO 16028 Connect Under Pressure Flat Face Plug/Male

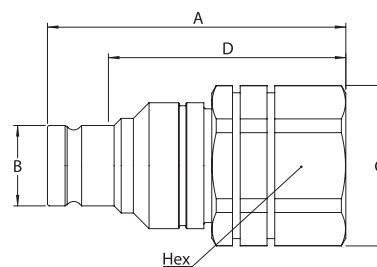

Figure 1

Plugs (Male)

Part Number	Body Size (in)	ISO Size (mm)	Nominal Flow Diameter (mm)	Thread Size* (Female)			Fig.	Dimensions										Weight	
				NPT	BSPP	SAE J 1926-1		A (in)	B (in)	C (in)	D (in)	Hex (in)	A (mm)	B (mm)	C (mm)	D (mm)	Hex (mm)	lbs	grams
10FFPCUP37	3/8	10	8.6	3/8-18	-		1	2.89	0.74	1.55	2.28	1.41	73.5	18.7	39.5	58.0	36	0.69	314
10FFPCUP37BS				-	3/8-19	1	2.89	0.74	1.55	2.28	1.41	73.5	18.7	39.5	58.0	36	0.69	314	
10FFPCUP50				1/2-14	-	1	2.89	0.74	1.55	2.28	1.41	73.5	18.7	39.5	58.0	36	0.66	300	
10FFPCUP50BS				-	1/2-14	1	2.89	0.74	1.55	2.28	1.41	73.5	18.7	39.5	58.0	36	0.66	300	
12FFPCUP50	1/2	12,5	11	1/2-14	-		1	3.03	0.96	1.55	2.36	1.41	77	24,52	39,5	60	36	0,77	350
12FFPCUP50BS				1/2-14	1	3,03	0,96	1,55	2,36	1,41	77	24,52	39,5	60	36	0,76	346		
12FFPCUP56UN				9/16 18f UNF1	1	2,87	0,96	1,55	2,2	1,41	73	24,52	39,5	56	36	0,74	336		
12FFPCUP75UN				3/4 16f UNF	1	3,03	0,96	1,55	2,36	1,41	77	24,52	39,5	60	36	0,77	351		

* Alternative end connections available upon request.

Color Coding Ring Option*

Body Size (in)	ISO Size (mm)	Nominal Flow Diameter (mm)	Plug/Male Ring Blue	Part Number**			Tool Part Number
				Red	Yellow	Green	
3/8	10	8.6	CR12FFPLB	CR12FFPRD	CR12FFPYL	CR12FFPDG	CR12FFSP93
1/2	12,5	11	CR16FFPLB	CR16FFPRD	CR16FFPYL	CR16FFPDG	CR16FFSP93

* For requests on alternative colours or installation instructions, please contact your Eaton sales representative.

** Orders must be in multiples of 10 pcs.

FD96 Series

High Pressure Thread to Connect Flush Face



Eaton's FD96 High Pressure Thread Together Flush Face Series is designed for high pressure and high impulse applications for hydraulic circuits. The FD96 Series design provides low connect and disconnect force in hydraulic circuits where trapped residual pressure must be addressed. The flush face design limits contamination and unwanted fluid loss. The FD96 Series is available in sizes 1/4" through 2" to best meet your specific size requirements.

Product Features

- Thread together design allows connection and disconnection under pressure up to 4,300 psi
- Low connection force
- Dual flush-face valving with non-spill design
- Working pressures up to 8,700 psi
- Body material: High resistance carbon steel with zinc trivalent and black oxide plating

Applications & Markets

- Hydraulic fluid transfer
- High impulse hydraulics
- Oil field
- Mining

Physical Characteristics

Body Size	Max. Operating Pressure						Min. Burst Pressure						Rated Flow (lpm)	Fluid Loss (gpm)	cc.	Req. Torque to Connect	
	Connected		Plug/Male Half		Socket/Female Half		Connected		Plug/Male Half		Socket/Female Half					lbs.	(N)
	(bar)	(psi)	(bar)	(psi)	(bar)	(psi)	(bar)	(psi)	(bar)	(psi)	(bar)	(psi)					
1/4	600	8,700	600	8,700	420	6,090	1,500	21,750	1,500	21,750	1,260	18,270	12	3.2	.012	29-37	40-50
3/8	550	7,980	550	7,980	330	4,785	1,400	20,300	1,400	20,300	1,000	14,500	23	6.1	.040	37-44	50-60
1/2	550	7,980	550	7,980	330	4,785	1,400	20,300	1,400	20,300	1,000	14,500	45	11.9	.025	48-55	65-75
3/4	550	7,980	550	7,980	330	4,785	1,400	20,300	1,400	20,300	1,000	14,500	74	19.6	.033	52-59	70-80
1	500	7,250	500	7,250	330	4,785	1,250	18,125	1,250	18,125	1,000	14,500	100	26.5	.018	66-81	90-110
1 1/4	470	6,800	470	6,800	300	4,350	1,200	17,400	1,200	17,400	800	11,600	189	50.1	.060	92-107	125-145
1 1/2	400	5,800	400	5,800	270	3,915	1,700	15,950	1,100	15,950	800	11,600	288	76.3	.200	114-129	155-175
2	350	5,080	350	5,080	270	3,915	1,100	15,950	1,100	15,950	800	11,600	379	100.4	.350	236-258	320-355

Flow Data

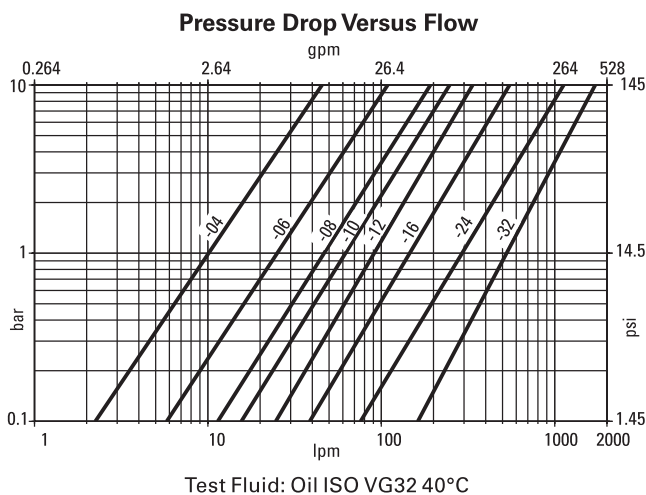

Connected Length

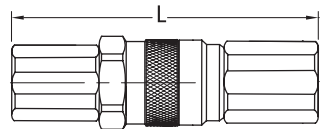

Body Size	Port Size	Connected Length "L"	
		mm	(in)
1/4	3/8	90.0	(3.54)
3/8	3/8	131.0	(5.16)
3/8	1/2	131.0	(5.16)
1/2	1/2	155.0	(6.10)
1/2	3/4	160.0	(6.30)
3/4	3/4	165.0	(6.50)
1	1	190.4	(7.50)
1	1 1/4	170.0	(6.69)
1 1/2	1 1/2	256.0	(10.08)
2	2	363.5	(14.31)

FD96 Series High Pressure Thread to Connect Flush Face

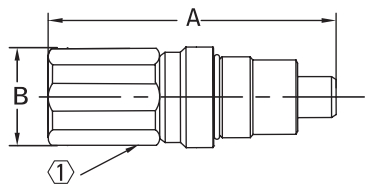

Figure 1

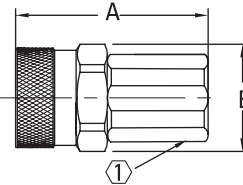

Figure 2

Dimensions (Female NPT)

Part Number	Coupling Type	Body Size	Port Size	Thread	Type	Fig.	Dimensions		Hex ①			
							A	B	mm	(in)	mm	(in)
FD96-1001-06-06	Socket/Female	3/8	3/8	3/8-18	Female NPT	2	65.8	(2.59)	41.8	(1.65)	30	(1.18)
FD96-1002-06-06	Plug/Male	3/8	3/8	3/8-18	Female NPT	1	82.5	(3.25)	37.8	(1.49)	27	(1.06)
FD96-1001-08-06	Socket/Female	3/8	1/2	1/2-14	Female NPT	2	70.8	(2.79)	41.8	(1.65)	30	(1.18)
FD96-1002-08-06	Plug/Male	3/8	1/2	1/2-14	Female NPT	1	85.0	(3.35)	37.8	(1.49)	27	(1.06)
FD96-1001-08-08	Socket/Female	1/2	1/2	1/2-14	Female NPT	2	77.8	(3.06)	49.8	(1.96)	36	(1.42)
FD96-1002-08-08	Plug/Male	1/2	1/2	1/2-14	Female NPT	1	95.0	(3.74)	45.8	(1.80)	36	(1.42)
FD96-1001-12-08	Socket/Female	1/2	3/4	3/4-14	Female NPT	2	84.8	(3.06)	49.8	(1.96)	36	(1.42)
FD96-1002-12-08	Plug/Male	1/2	3/4	3/4-14	Female NPT	1	97.4	(3.83)	45.8	(1.80)	36	(1.42)
FD96-1001-12-12	Socket/Female	3/4	3/4	3/4-14	Female NPT	2	84.9	(3.34)	53.8	(2.12)	41	(1.61)
FD96-1002-12-12	Plug/Male	3/4	3/4	3/4-14	Female NPT	1	99.0	(3.90)	49.8	(1.96)	36	(1.42)
FD96-1001-12-16	Socket/Female	1	3/4	3/4-14	Female NPT	2	96.7	(3.81)	58.8	(2.31)	46	(1.81)
FD96-1002-12-16	Plug/Male	1	3/4	3/4-14	Female NPT	1	113.6	(4.47)	54.8	(2.16)	46	(1.81)
FD96-1001-16-16	Socket/Female	1	1	1-11 1/2	Female NPT	2	99.7	(3.93)	58.8	(2.31)	46	(1.81)
FD96-1002-16-16	Plug/Male	1	1	1-11 1/2	Female NPT	1	113.6	(4.47)	54.8	(2.16)	46	(1.81)
FD96-1001-16-20	Socket/Female	1 1/4	1	1-11 1/2	Female NPT	2	105.8	(4.17)	69.8	(2.75)	55	(2.17)
FD96-1002-16-20	Plug/Male	1 1/4	1	1-11 1/2	Female NPT	1	123.4	(4.86)	64.5	(2.54)	55	(2.17)
FD96-1001-20-20	Socket/Female	1 1/4	1 1/4	1 1/4-11 1/2	Female NPT	2	106.8	(4.20)	69.8	(2.75)	55	(2.17)
FD96-1002-20-20	Plug/Male	1 1/4	1 1/4	1 1/4-11 1/2	Female NPT	1	123.4	(4.86)	64.5	(2.54)	55	(2.17)
FD96-1001-20-24	Socket/Female	1 1/2	1 1/4	1 1/4-11 1/2	Female NPT	2	133.5	(5.26)	92.0	(3.62)	65	(2.56)
FD96-1002-20-24	Plug/Male	1 1/2	1 1/4	1 1/4-11 1/2	Female NPT	1	150.0	(5.91)	89.8	(3.54)	65	(2.56)
FD96-1001-24-24	Socket/Female	1 1/2	1 1/2	1 1/2-11 1/2	Female NPT	2	133.5	(5.26)	92.0	(3.62)	65	(2.56)
FD96-1002-24-24	Plug/Male	1 1/2	1 1/2	1 1/2-11 1/2	Female NPT	1	150.0	(5.91)	89.8	(3.54)	65	(2.56)
FD96-1001-32-32	Socket/Female	2	2	2-11 1/2	Female NPT	2	224.8	(8.85)	200.0	(7.87)	90	(3.54)
FD96-1002-32-32	Plug/Male	2	2	2-11 1/2	Female NPT	1	218.4	(8.60)	145.0	(5.71)	90	(3.54)

Dimensions (Female SAE O-Ring)

Part Number	Coupling Type	Body Size	Port Size	Thread	Type	Fig.	Dimensions		Hex ①			
							A	B	mm	(in)	mm	(in)
FD96-1004-06-04	Socket/Female	1/4	3/8	9/16-18 UNF	Female SAE O-Ring	2	57.1	(2.25)	38.8	(1.53)	27	(1.06)
FD96-1005-06-04	Plug/Male	1/4	3/8	9/16-18 UNF	Female SAE O-Ring	1	72.8	(2.87)	34.8	(1.37)	22	(.87)
FD96-1004-08-06	Socket/Female	3/8	1/2	3/4-16 UNF	Female SAE O-Ring	2	70.8	(2.79)	41.8	(1.65)	30	(1.18)
FD96-1005-08-06	Plug/Male	3/8	1/2	3/4-16 UNF	Female SAE O-Ring	1	87.0	(3.43)	37.8	(1.49)	27	(1.06)
FD96-1004-12-08	Socket/Female	1/2	3/4	11/16-12 UNF	Female SAE O-Ring	2	84.8	(3.06)	49.8	(1.96)	36	(1.42)
FD96-1005-12-08	Plug/Male	1/2	3/4	11/16-12 UNF	Female SAE O-Ring	1	100.4	(3.95)	45.8	(1.80)	36	(1.42)
FD96-1004-12-12	Socket/Female	3/4	3/4	11/16-12 UNF	Female SAE O-Ring	2	84.9	(3.34)	53.8	(2.12)	41	(1.61)
FD96-1005-12-12	Plug/Male	3/4	3/4	11/16-12 UN	Female SAE O-Ring	1	102.0	(4.02)	49.8	(1.96)	36	(1.42)
FD96-1004-12-16	Socket/Female	1	3/4	11/16-12 UN	Female SAE O-Ring	2	99.7	(3.93)	58.8	(2.31)	46	(1.81)
FD96-1005-12-16	Plug/Male	1	3/4	11/16-12 UN	Female SAE O-Ring	1	115.6	(4.55)	54.8	(2.16)	46	(1.81)
FD96-1004-16-16	Socket/Female	1	1	15/16-12 UN	Female SAE O-Ring	2	99.7	(3.93)	58.8	(2.31)	46	(1.81)
FD96-1005-16-16	Plug/Male	1	1	15/16-12 UN	Female SAE O-Ring	1	113.6	(4.47)	54.8	(2.16)	46	(1.81)
FD96-1004-16-20	Socket/Female	1 1/4	1	15/16-12 UN	Female SAE O-Ring	2	105.8	(4.17)	69.8	(2.75)	55	(2.17)
FD96-1005-16-20	Plug/Male	1 1/4	1	15/16-12 UN	Female SAE O-Ring	1	125.4	(4.94)	64.5	(2.54)	55	(2.17)
FD96-1004-20-20	Socket/Female	1 1/4	1 1/4	15/8-12 UN	Female SAE O-Ring	2	106.8	(4.20)	69.8	(2.75)	55	(2.17)
FD96-1005-20-20	Plug/Male	1 1/4	1 1/4	15/8-12 UN	Female SAE O-Ring	1	123.4	(4.86)	64.5	(2.54)	55	(2.17)
FD96-1004-20-24	Socket/Female	1 1/2	1 1/4	15/8-12 UN	Female SAE O-Ring	2	133.5	(5.26)	92.0	(3.62)	65	(2.56)
FD96-1005-20-24	Plug/Male	1 1/2	1 1/4	15/8-12 UN	Female SAE O-Ring	1	150.0	(5.91)	89.8	(3.54)	65	(2.56)
FD96-1004-24-24	Socket/Female	1 1/2	1 1/2	17/8-12 UN	Female SAE O-Ring	2	133.5	(5.26)	92.0	(3.62)	65	(2.56)
FD96-1005-24-24	Plug/Male	1 1/2	1 1/2	17/8-12 UN	Female SAE O-Ring	1	150.0	(5.91)	89.8	(3.54)	65	(2.56)
FD96-1004-32-32	Socket/Female	2	2	2 1/2-12 UN	Female SAE O-Ring	2	224.8	(8.85)	200.0	(7.87)	90	(3.54)
FD96-1005-32-32	Plug/Male	2	2	2 1/2-12 UN	Female SAE O-Ring	1	218.4	(8.60)	145.0	(5.71)	90	(3.54)

Dust Caps and Dust Plugs

Body Size	Part Number	Coupling Type	Cap Material	Body Size	Part Number	Coupling Type	Cap Material
1/4	FD96-1009-04	Socket/Female	Aluminum	1/4	FD96-1010-04	Plug/Male	Aluminum
3/8	FD96-1009-06	Socket/Female	Aluminum	3/8	FD96-1010-06	Plug/Male	Aluminum
1/2	FD96-1009-08	Socket/Female	Aluminum	1/2	FD96-1010-08	Plug/Male	Aluminum
3/4	FD96-1009-12	Socket/Female	Aluminum	3/4	FD96-1010-12	Plug/Male	Aluminum
1	FD96-1009-16	Socket/Female	Aluminum	1	FD96-1010-16	Plug/Male	Aluminum
1 1/4	FD96-1009-20	Socket/Female	Aluminum	1 1/4	FD96-1010-20	Plug/Male	Aluminum
1 1/2	FD96-1009-24	Socket/Female	Aluminum	1 1/2	FD96-1010-24	Plug/Male	Aluminum
2	FD96-1009-32	Socket/Female	Aluminum	2	FD96-1010-32	Plug/Male	Aluminum

FD49 Series

NFPA Standard T3.20.15 HTMA Interchange



Eaton's FD49 Series meets NFPA standard T3.20.15 and was developed in conjunction with HTMA (Hydraulic Tool Manufacturer's Association). Eaton's Twin-Guard™ sealing system prevents weepage at low pressures and allows connection and disconnection against pressure up to 500 psi.

Product Features

- Dual flush face valving for minimal fluid loss and air inclusion
- Tubular valve and sleeve construction for high fluid flow with low pressure drop
- Push-to-connect latching for one hand operation
- Standard seal material: Teflon channel seal and Buna-N O-Ring backup
- Standard body material: High resistance carbon steel with zinc trivalent plating

Physical Characteristics

Body Size (in)	Max. Operating Pressure		Min. Burst Pressure Connected		Vacuum Connected Only	Rated Flow		Air Inclusion	Fluid Loss
	(bar)	(psi)	(bar)	(psi)	(in./Hg)	(lpm)	(gpm)	cc. max.	cc.max.
3/8	207	3,000	621	9,000	28	38	10	.01	.02



Um nome carregado de soluções

Eaton's Twin-Guard™ seal system consists of channel and Buna-N O-Ring seals. The channel seal prevents blowout during connection and disconnection under pressure to 500 psi. The Buna-N O-Ring seal is a secondary seal eliminating fluid weepage.

Applications & Markets

- Hydraulic tool (HTMA interchange)
- Hydraulic and fluid transfer

Flow Data

Pressure Drop Versus Flow Graph

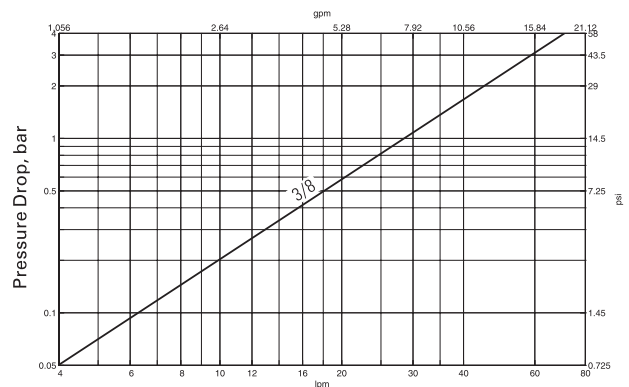

Gallons Per Minute Flow
Test Fluid: MIL-H-5606 Oil at 100°F

FD49 Series

NFPA Standard T3.20.15 HTMA Interchange

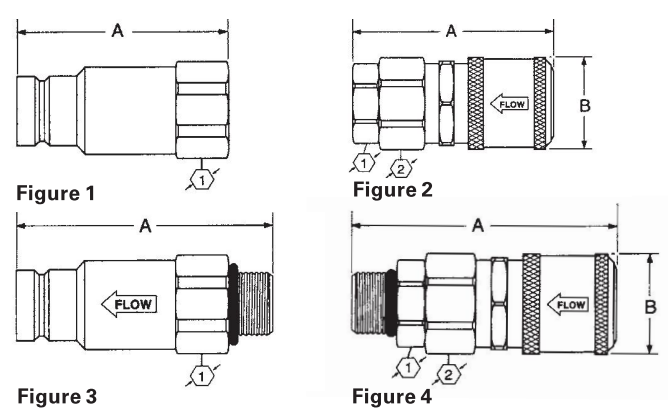

Dimensions (Female NPT, Valved)

Part Number Buna-N	Coupling Type	Body Size	Port Size	Thread	Type	Fig.	Dimensions		Hex ①		Hex ②	
							A	B	mm	(in)	mm	(in)
FD49-1002-06-06	Plug/Male	3/8	3/8	3/8-18	Female NPT	1	66.5	-	25.4	-	-	-
FD49-1001-06-06	Socket/Female	3/8	3/8	3/8-18	Female NPT	2	69.6	30.5	25.4	26.9	(1.00)	(1.06)
FD49-1002-08-06	Plug/Male	3/8	1/2	1/2-14	Female NPT	1	69.9	-	26.9	-	-	-
FD49-1001-08-06	Socket/Female	3/8	1/2	1/2-14	Female NPT	2	72.4	30.5	-	-	-	26.9 (1.06)

Dimensions (Female SAE O-Ring, Valved)

Part Number Buna-N	Coupling Type	Body Size	Port Size	Thread	Type	Fig.	Dimensions		Hex ①		Hex ②	
							A	B	mm	(in)	mm	(in)
FD49-1004-08-06	Plug/Male	3/8	3/4	3/4-16	Female SAE O-Ring	1	69.9	-	26.9	-	-	-
FD49-1005-08-06	Socket/Female	3/8	3/4	3/4-16	Female SAE O-Ring	2	71.6	30.5	-	-	-	26.9 (1.06)

Dimensions (Male SAE O-Ring, Valved)

Part Number Buna-N	Coupling Type	Body Size	Port Size	Thread	Type	Fig.	Dimensions		Hex ①		Hex ②	
							A	B	mm	(in)	mm	(in)
FD49-1057-06-06	Plug/Male	3/8	9/16	9/16-18	Male SAE O-Ring	3	75.9	-	25.4	-	-	-
FD49-1014-06-06	Socket/Female	3/8	9/16	9/16-18	Male SAE O-Ring	4	81.8	30.5	25.4	26.9	(1.00)	(1.06)
FD49-1057-08-06	Plug/Male	3/8	3/4	3/4-16	Male SAE O-Ring	3	75.9	-	25.4	-	-	-
FD49-1014-08-06	Socket/Female	3/8	3/4	3/4-16	Male SAE O-Ring	4	83.3	30.5	25.4	26.9	(1.00)	(1.06)

Dust Cap/Plug, Standard Coupling

Part Number (Buna-N)	Body Size
FD49-1042-06	3/8

Note: Fits male and female halves.



Um nome carregado de soluções

MLDB Series (Stainless Steel) Flat Face/Dry Break



Eaton's MLDB Series stainless steel coupling is a flat face/dry break coupling used for fluid transfer applications. The MLDB Series offers the ability to connect with less force, higher sealing performance and are available in multiple configurable end connections.

Product Features

- Designed and manufactured in accordance with Article 3.3 of the European Pressure Equipment Directive PED 2014/68/EU
- Safety sleeve lock prevents accidental disconnections
- Push to connect with double shut-off valving
- Capable of working under high temperature applications
- Shock resistant color coding ring option available in 1/2" size
- Serviceable design allows for easy cleaning and seal replacement
- Designed with higher flow capacity and resistance to aggressive fluids and corrosion
- Standard body material: 316/316L Stainless steel corrosion resistant
- Standard seal material: FKM, EPDM, Kalrez® and generic FFKM

Physical Characteristics

Body Size (in)	Nominal Flow Diameter (mm)	Max. Operating Pressure		Rated* Flow		Air Inclusion	Fluid Loss	Force to Connect	
		(bar)	(psi)	(lpm)	(gpm)	ml-cc.	ml-cc.	N	lbf
¼	5.9	25	360	15	4	0.002	0.001	85	19
½	11.5	25	360	73	19	0.012	0.025	150	34
¾	15.0	25	360	120	32	0.030	0.050	170	38
1	18.5	25	360	200	53	0.150	0.130	180	41

* Indicated values refer to a 1 bar/14.5 psi pressure drop.

Applications & Markets

- Process/Fluid transfer
- Cooling
- Corrosive environments
- Chemicals/Petrochemicals
- Pharmaceuticals
- Food processing
- Electrical

Flow Data

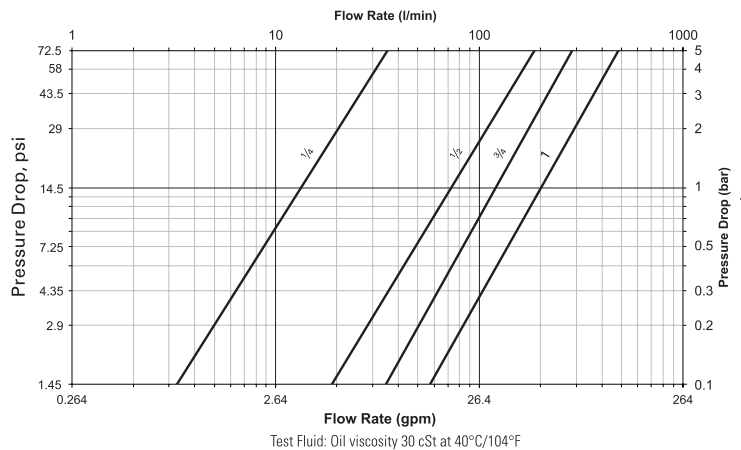

Seal Elastomer Data*

Seal Elastomer	Max. Operation Temperature Range
FKM	-20°C +200°C/-4°F +392°F
EPDM (Ethylene-Propylene)	-40°C +150°C/-40°F +302°F
Kalrez® 6375	-20°C +275°C/-4°F +527°F
Generic FFKM (Perfluorocarbon)	-15°C +275°C/+5°F +527°F

* For reference only, based on Eaton recommended temperatures. Contact Eaton technical support for further information on fluid compatibility

MLDB Series (Stainless Steel) Flat Face/Dry Break

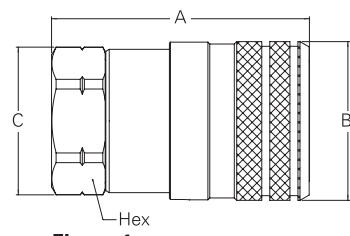

Figure 1

Sockets(Female)

Part Number	Thread Size*(Female)							Dimensions						Weight			
FKM	EPDM	Kalrez® 6375	Generic FFKM	Body Size	NPT	BSPP	Fig.	A (in)	B (in)	C (in)	Hex (in)	A (mm)	B (mm)	C (mm)	Hex (mm)	lbs	grams
ML2DBS25FBS	ML2DBS25FBS292	ML2DBS25FBS242	ML2DBS25FBS503	1/4	–	1/4-19	1	1.79	1.06	0.96	0.87	45.4	26.8	24.5	22	0.26	116
ML2DBS25F	ML2DBS25F292	ML2DBS25F242	ML2DBS25F503	1/4	1/4-18		1	1.73	1.06	0.96	0.87	43.9	26.8	24.5	22	0.26	116
ML4DBS50FBS	ML4DBS50FBS292	ML4DBS50FBS242	ML4DBS50FBS503	1/2	–	1/2-14	1	2.44	1.5	1.4	1.26	61.9	38.2	35.5	32	0.73	330
ML4DBS50F	ML4DBS50F292	ML4DBS50F242	ML4DBS50F503	1/2	1/2-14		1	2.44	1.5	1.4	1.26	61.9	38.2	35.5	32	0.73	330
ML6DBS75FBS	ML6DBS75FBS292	ML6DBS75FBS242	ML6DBS75FBS503	3/4	–	3/4-14	1	3.02	1.89	1.83	1.61	76.8	47.9	46.5	41	1.34	610
ML6DBS75F	ML6DBS75F292	ML6DBS75F242	ML6DBS75F503	3/4	3/4-14		1	3.02	1.89	1.83	1.61	76.8	47.9	46.5	41	1.34	610
ML8DBS100FBS	ML8DBS100FBS292	ML8DBS100FBS242	ML8DBS100FBS503	1	–	1-11	1	3.54	2.26	2.16	1.97	89.9	57.4	54.9	50	2.31	1050
ML8DBS100F	ML8DBS100F292	ML8DBS100F242	ML8DBS100F503	1	1-11 1/2		1	3.42	2.26	2.16	1.97	86.9	57.4	54.9	50	2.31	1050

*Alternative end connections available upon request.

To obtain connected length of coupling, add dimensions A (Fig. 1) and G (Fig. 2) together.

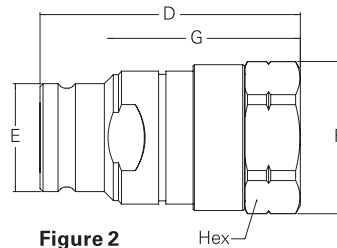

Figure 2

Plugs(Male)

Part Number	Thread Size*(Female)							Dimensions						Weight					
FKM	EPDM	Kalrez® 6375	Generic FFKM	Body Size	NPT	BSPP	Fig.	D (in)	E (in)	F (in)	G (in)	Hex (in)	D (mm)	E (mm)	F (mm)	G (mm)	Hex (mm)	lbs	grams
ML2DBP25FBS	ML2DBP25FBS292	ML2DBP25FBS242	ML2DBP25FBS503	1/4	–	1/4-19	2	1.72	0.65	0.96	1.31	0.87	43.6	16.5	24.5	33.2	22	0.17	78
ML2DBP25F	ML2DBP25F292	ML2DBP25F242	ML2DBP25F503	1/4	1/4-18		2	1.66	0.65	0.96	1.25	0.87	42.1	16.5	24.5	31.7	22	0.17	78
ML4DBP50FBS	ML4DBP50FBS292	ML4DBP50FBS242	ML4DBP50FBS503	1/2	–	1/2-14	2	2.39	0.99	1.4	1.8	1.26	60.7	25.2	35.5	45.7	32	0.46	210
ML4DBP50F	ML4DBP50F292	ML4DBP50F242	ML4DBP50F503	1/2	1/2-14		2	2.39	0.99	1.4	1.8	1.26	60.7	25.2	35.5	45.7	32	0.46	210
ML6DBP75FBS	ML6DBP75FBS292	ML6DBP75FBS242	ML6DBP75FBS503	3/4	–	3/4-14	2	2.97	1.29	1.83	2.11	1.61	75.5	32.8	46.5	53.6	41	0.87	395
ML6DBP75F	ML6DBP75F292	ML6DBP75F242	ML6DBP75F503	3/4	3/4-14		2	2.97	1.29	1.83	2.11	1.61	75.5	32.8	46.5	53.6	41	0.87	395
ML8DBP100FBS	ML8DBP100FBS292	ML8DBP100FBS242	ML8DBP100FBS503	1	–	1-11	2	3.52	1.59	2.16	2.60	1.97	89.4	40.4	54.9	66.1	50	1.54	700
ML8DBP100F	ML8DBP100F292	ML8DBP100F242	ML8DBP100F503	1	1-11 1/2		2	3.4	1.59	2.16	2.48	1.97	86.4	40.4	54.9	63.1	50	1.54	700

*Alternative end connections available upon request.

To obtain connected length of coupling, add dimensions A (Fig. 1) and G (Fig. 2) together.

Seal Kit and Tool for Servicing Sockets (Female)

Body Size	Tool Part Number	Seal Kit Part Number (includes 5 sets)		Seal Kit Part Number (includes 1 set)	
		FKM	EPDM	Kalrez 6375	Generic FFKM
1/4	ML2DBS93	2DBSG143	2DBSG292	2DBSG242	2DBSG503
1/2	ML4DBS93	4DBSG143	4DBSG292	4DBSG242	4DBSG503
3/4	ML6DBS93	6DBSG143	6DBSG292	6DBSG242	6DBSG503
1	ML8DBS93	8DBSG143	8DBSG292	8DBSG242	8DBSG503

For installation instructions, please contact your Eaton sales representative.

Seal Kit for Servicing Plugs (Male)

Body Size	Seal Kit Part Number (includes 5 sets)		Seal Kit Part Number (includes 1 set)	
	FKM	EPDM	Kalrez 6375	Generic FFKM
1/4	2DBPG143	2DBPG292	2DBPG242	2DBPG503
1/2	4DBPG143	4DBPG292	4DBPG242	4DBPG503
3/4	6DBPG143	6DBPG292	6DBPG242	6DBPG503
1	8DBPG143	8DBPG292	8DBPG242	8DBPG503

For installation instructions, please contact your Eaton sales representative. No tool required for servicing of the plug(male).

Color Coding Ring Option*

Body Size	Socket/Female Ring**		Plug/Male Ring**		Tool Part Number	Tool & Rings Kit Part Number***
	Color	Part Number	Color	Part Number		
1/2	Blue	CR12FFSLB	Blue	CR12FFPLB	CR4DBSP93	CRKIT4DB
	Red	CR12FFSRD	Red	CR12FFPRD		
	Yellow	CR12FFSYL	Yellow	CR12FFPYL		
	Green	CR12FFSDG	Green	CR12FFPDG		

*For requests on other sizes, alternative colors or installation instructions, please contact your Eaton sales representative.

**Orders must be in multiples of 10 pcs.

***The kit consists of a tool plus 10 socket rings and 10 plug rings of each color.

5100 Series Thread to Connect



Eaton's 5100 Series brass coupling with steel tubular valve offers minimum air inclusion and fluid loss. Thread together latch provides connect under pressure capability and vibration resistance. The 5100 Series is not rated for continuous hydraulic impulse applications. For hydraulic impulse applications, refer to the FD86 and FD96 Series thread to connect product lines.

Product Features

- Tubular valve construction for virtually no fluid loss during disconnection, reduces environmental and worker safety hazards
- Low air inclusion during connection maintains system performance
- Available with wing or hex nut configurations
- Connect against pressure capability allows connecting of halves even when pressurized up to 500 psi
- Steel flange available for accessible bulkhead mounting
- Standard seal material: Buna-N
- Standard body material: Brass body with high resistance carbon steel with zinc trivalent plated valving components, hex and wing nuts

Physical Characteristics

Body Dash Size	Body Interface Size	Max. Operating Pressure Connected		Max. Operating Pressure Disconnected				Rated Flow	Air Inclusion	Fluid Loss		
				Plug/Male Half S2 and S4		Socket/Female Half S5						
(in)	(in)	(bar)	(psi)	(bar)	(psi)	(bar)	(psi)	(in./Hg)	(lpm)	(gpm)	cc. max.	cc. max.
1/4	1/4	207	3,000	207	3,000	207	3,000	28	15	4	.03	.01
3/8	1/2	207	3,000	207	3,000	207	3,000	28	26	7	.05	.06
1/2	1/2	207	3,000	207	3,000	207	3,000	28	26	7	.05	.10
5/8	3/4	207	3,000	207	3,000	207	3,000	28	68	18	.14	.10
3/4	3/4	207	3,000	207	3,000	207	3,000	28	68	18	.34	.26
1	1	207	3,000	207	3,000	207	3,000	28	151	40	.50	.35
1 1/4	1 1/4	190	2,750	172	2,500	190	2,750	28	284	75	.68	.70
1 1/2	1 1/2	172	2,500	172	2,500	138	2,000	28	379	100	.60	.94

Applications & Markets

- Hydraulics and fluid transfer
- On-highway hydraulic wet lines
- Dump and refuse vehicles
- Bulk liquid transfer

Flow Data

Pressure Drop Versus Flow Graph

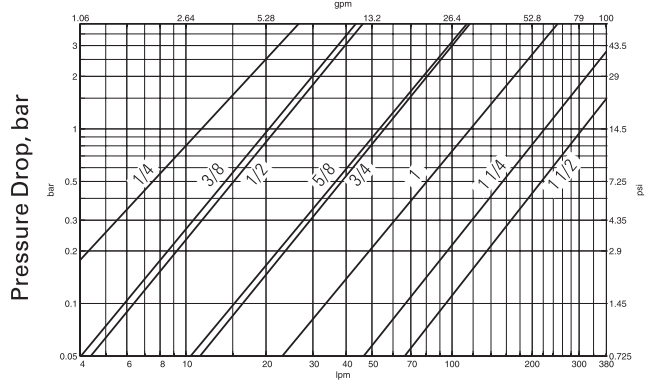

Gallons Per Minute Flow
Test Fluid: MIL-H-5606 Oil at 100°F

5100 Series Thread to Connect

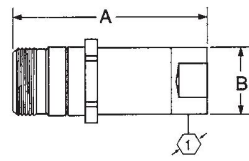

Figure 1

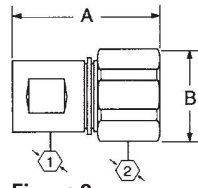

Figure 2

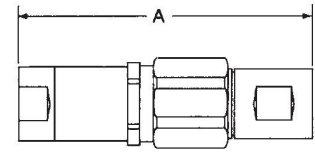

Figure 3

Dimensions (Female NPT, Valved without Flange)

Part Number	Buna-N Type	Coupling Size	Body Size	Port Thread	Type	Fig.	Dimensions		B		Hex ①		Hex ②	
							A	B	mm	(in)	mm	(in)	mm	(in)
5100-S2-4B	Plug/Male	1/4	1/8	1/8-27	Female NPT	1	47.8	(1.88)	22.9	(.90)	17.5	(.69)	-	-
5110-S5-4B	Socket/Female	1/4	1/8	1/8-27	Female NPT	2	53.3	(2.10)	33.5	(1.32)	14.2	(.56)	30.2	(1.19)
5111-4B	Complete	1/4	1/8	1/8-27	Female NPT	3	81.3	(3.20)	-	-	-	-	-	-
5100-S2-6B	Plug/Male	3/8	1/4	1/4-18	Female NPT	1	65.5	(2.58)	26.7	(1.05)	23.9	(.94)	-	-
5110-S5-6B	Socket/Female	3/8	1/4	1/4-18	Female NPT	2	61.0	(2.40)	38.9	(1.53)	19.3	(.76)	35.1	(1.38)
5111-6B	Complete	3/8	1/4	1/4-18	Female NPT	3	104.4	(4.11)	-	-	-	-	-	-
5100-S2-8B	Plug/Male	1/2	3/8	3/8-18	Female NPT	1	65.5	(2.58)	26.7	(1.05)	23.9	(.94)	-	-
5110-S5-8B	Socket/Female	1/2	3/8	3/8-18	Female NPT	2	61.0	(2.40)	38.9	(1.53)	19.3	(.76)	35.1	(1.38)
5111-8B	Complete	1/2	3/8	3/8-18	Female NPT	3	104.4	(4.11)	-	-	-	-	-	-
5100-S2-10B	Plug/Male	5/8	1/2	1/2-14	Female NPT	1	79.0	(3.11)	35.1	(1.38)	30.2	(1.19)	-	-
5110-S5-10B	Socket/Female	5/8	1/2	1/2-14	Female NPT	2	78.0	(3.07)	50.3	(1.98)	29.5	(1.16)	44.5	(1.75)
5111-10B	Complete	5/8	1/2	1/2-14	Female NPT	3	132.3	(5.21)	-	-	-	-	-	-
5100-S2-12B	Plug/Male	3/4	3/4	3/4-14	Female NPT	1	79.0	(3.11)	35.1	(1.38)	30.2	(1.19)	-	-
5110-S5-12B	Socket/Female	3/4	3/4	3/4-14	Female NPT	2	78.0	(3.07)	50.3	(1.98)	29.5	(1.16)	44.5	(1.75)
5111-12B	Complete	3/4	3/4	3/4-14	Female NPT	3	132.3	(5.21)	-	-	-	-	-	-
5100-S2-16B	Plug/Male	1	1	1-11 1/2	Female NPT	1	90.2	(3.55)	44.2	(1.74)	39.6	(1.56)	-	-
5110-S5-16B	Socket/Female	1	1	1-11 1/2	Female NPT	2	93.5	(3.68)	61.2	(2.41)	36.6	(1.44)	53.8	(2.12)
5111-16B	Complete	1	1	1-11 1/2	Female NPT	3	151.9	(5.98)	-	-	-	-	-	-
5100-S2-20B	Plug/Male	1 1/4	1 1/4	1 1/4 - 11 1/2	Female NPT	1	94.2	(3.71)	52.8	(2.08)	47.8	(1.88)	-	-
5110-S5-20B	Socket/Female	1 1/4	1 1/4	1 1/4 - 11 1/2	Female NPT	2	101.6	(4.00)	58.7	(2.31)	45.2	(1.78)	63.5	(2.50)
5111-20B	Complete	1 1/4	1 1/4	1 1/4 - 11 1/2	Female NPT	3	160.3	(6.31)	-	-	-	-	-	-
5100-S2-24B	Plug/Male	1 1/2	1 1/2	1 1/2 - 11 1/2	Female NPT	1	104.6	(4.12)	62.5	(2.46)	55.6	(2.19)	55.6	(2.19)
5110-S5-24B	Socket/Female	1 1/2	1 1/2	1 1/2 - 11 1/2	Female NPT	2	104.1	(4.10)	78.7	(3.10)	50.8	(2.00)	-	-
5111-24B	Complete	1 1/2	1 1/2	1 1/2 - 11 1/2	Female NPT	3	165.6	(6.52)	-	-	-	-	-	-

PNEUMATIC

SPECIAL APPLICATIONS

DIAGNOSTIC

AGRICULTURE

REFRIGERANT

5100 Series Thread to Connect

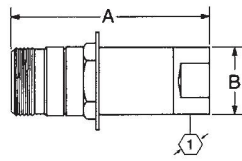

Figure 4

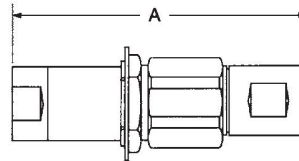

Figure 5

Dimensions (Female NPT, Valved WITH Flange)

Part Number Buna-N	Coupling Type	Body Size	Port Size	Thread	Type	Fig.	Dimensions					
							A		B		Hex ①	
							mm	(in)	mm	(in)	mm	(in)
5100-S4-4B	Plug/Male	1/4	1/8	1/8-27	Female NPT	4	47.8	(1.88)	22.4	(.88)	23.3	(.96)
5110-4B	Complete	1/4	1/8	1/8-27	Female NPT	5	81.3	(3.20)	-	-	-	-
5100-S4-6B	Plug/Male	3/8	1/4	1/4-18	Female NPT	4	65.5	(2.58)	26.7	(1.05)	28.5	(1.12)
5110-6B	Complete	3/8	1/4	1/4-18	Female NPT	5	104.4	(4.11)	-	-	-	-
5100-S4-8B	Plug/Male	1/2	3/8	3/8-18	Female NPT	4	65.5	(2.58)	26.7	(1.05)	28.5	(1.12)
5110-8B	Complete	1/2	3/8	3/8-18	Female NPT	5	104.4	(4.11)	-	-	-	-
5100-S4-10B	Plug/Male	5/8	1/2	1/2-14	Female NPT	4	79.0	(3.11)	35.2	(1.35)	41.2	(1.62)
5110-10B	Complete	5/8	1/2	1/2-14	Female NPT	5	132.3	(5.21)	-	-	-	-
5100-S4-12B	Plug/Male	3/4	3/4	3/4-14	Female NPT	4	79.0	(3.11)	35.2	(1.35)	41.2	(1.62)
5110-12B	Complete	3/4	3/4	3/4-14	Female NPT	5	132.3	(5.21)	-	-	-	-
5100-S4-16B	Plug/Male	1	1	1-11 1/2	Female NPT	4	90.2	(3.55)	44.2	(1.74)	47.8	(1.88)
5100-S4-20B	Plug/Male	1 1/4	1 1/4	1 1/4 - 11 1/2	Female NPT	4	94.2	(3.71)	52.8	(2.08)	53.9	(2.12)
5110-20B	Complete	1 1/4	1 1/4	1 1/4 - 11 1/2	Female NPT	5	160.3	(6.31)	-	-	-	-
5100-S4-24B	Plug/Male	1 1/2	1 1/2	1 1/2 - 11 1/2	Female NPT	4	104.6	(4.12)	62.5	(2.46)	63.5	(2.50)

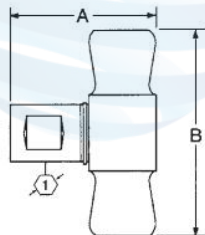

Figure 6

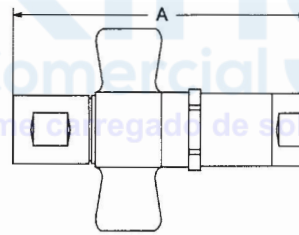

Figure 7

Dimensions (Female NPT, Valved WITH Wing Nut Less Flange)

Part Number Buna-N	Coupling Type	Body Size	Port Size	Thread	Type	Fig.	Dimensions					
							A		B		Hex ①	
							mm	(in)	mm	(in)	mm	(in)
5100-S5-4B	Socket/Female	1/4	1/8	1/8-27	Female NPT	6	53.3	(2.10)	77.0	(3.03)	14.2	(.56)
5101-4B	Complete	1/4	1/8	1/8-27	Female NPT	7	81.3	(3.20)	-	-	-	-
5100-S5-6B	Socket/Female	3/8	1/4	1/4-18	Female NPT	6	61.0	(2.40)	87.4	(3.44)	19.3	(.76)
5101-6B	Complete	3/8	1/4	1/4-18	Female NPT	7	104.4	(4.11)	-	-	-	-
5100-S5-8B	Socket/Female	1/2	3/8	3/8-18	Female NPT	6	61.0	(2.40)	87.4	(3.44)	19.3	(.76)
5101-8B	Complete	1/2	3/8	3/8-18	Female NPT	7	104.4	(4.11)	-	-	-	-
5100-S5-10B	Socket/Female	5/8	1/2	1/2-14	Female NPT	6	78.0	(3.07)	104.9	(4.13)	29.5	(1.16)
5101-10B	Complete	5/8	1/2	1/2-14	Female NPT	7	132.3	(5.21)	-	-	-	-
5100-S5-12B	Socket/Female	3/4	3/4	3/4-14	Female NPT	6	78.0	(3.07)	104.9	(4.13)	29.5	(1.16)
5101-12B	Complete	3/4	3/4	3/4-14	Female NPT	7	132.3	(5.21)	-	-	-	-
5100-S5-16B	Socket/Female	1	1	1-11 1/2	Female NPT	6	93.5	(3.68)	111.3	(4.38)	36.6	(1.44)
5101-16B	Complete	1	1	1-11 1/2	Female NPT	7	151.9	(5.98)	-	-	-	-
5100-S5-20B	Socket/Female	1 1/4	1 1/4	1 1/4 - 11 1/2	Female Pipe	6	101.6	(4.00)	133.9	(5.27)	45.2	(1.78)
5101-20B	Complete	1 1/4	1 1/4	1 1/4 - 11 1/2	Female NPT	7	160.3	(6.31)	-	-	-	-
5100-S5-24B	Socket/Female	1 1/2	1 1/2	1 1/2 - 11 1/2	Female NPT	6	104.1	(4.10)	136.7	(5.38)	50.8	(2.00)
5101-24B	Complete	1 1/2	1 1/2	1 1/2 - 11 1/2	Female NPT	7	165.6	(6.52)	-	-	-	-

Note: Uses the 5100-S2 series plug/male half shown on page 50.

5100 Series Thread to Connect

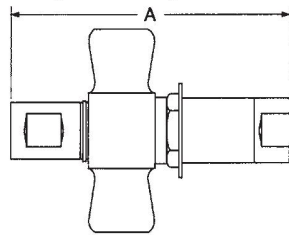

Figure 8

Dimensions (Female NPT, Valved WITH Wing Nut and Flange)

Part Number Buna-N	Coupling Type	Body Size	Port Size	Thread	Type	Fig. A	Dimensions	
							mm	(in)
5100-4B	Complete	1/4	1/8	1/8-27	Female NPT	8	81.3	(3.24)
5100-6B	Complete	3/8	1/4	1/4-18	Female NPT	8	104.4	(4.11)
5100-8B	Complete	1/2	3/8	3/8-18	Female NPT	8	104.4	(4.11)
5100-10B	Complete	5/8	1/2	1/2-14	Female NPT	8	132.3	(5.21)
5100-12B	Complete	3/4	3/4	3/4-14	Female NPT	8	132.3	(5.21)
5100-16B	Complete	1	1	1-11 1/2	Female NPT	8	151.9	(5.89)
5100-20B	Complete	1 1/4	1 1/4	1 1/4 - 11 1/2	Female NPT	8	160.3	(6.33)
5100-24B	Complete	1 1/2	1 1/2	1 1/2 - 11 1/2	Female NPT	8	165.6	(6.54)

Note: Uses the 5100-S2 series plug/male half shown on page 50.

Repair Kits

Part Number Buna-N	Body Size
FF098-04	1/4
FF098-08	3/8 & 1/2
FF098-12	5/8 & 3/4
FF098-16	1
FF098-20	1 1/4
FF098-24	1 1/2

Note: Each kit will repair both plug/male and socket/female halves.

Dust Caps and Dust Plugs

Part Number Dust Cap with Chain	Dust Plug with Chain	Body Size
5100-S7-5	5100-S9-5	1/4
5100-S7-8	5100-S9-8	3/8 & 1/2
5100-S7-12	5100-S9-12	5/8 & 3/4
5100-S7-16	5100-S9-16	1
5100-S7-20	5100-S9-20	1 1/4
5100-S7-24	5100-S9-24	1 1/2



6-Bolt Flange Assembly

Part Number 6-Bolt Flange Assembly	Body Size	Dimensions A		B	
		mm	(in)	mm	(in)
150-22-5	1/4	5.11	(.201)	33.6	(1.44)
150-22-8	3/8 & 1/2	5.11	(.201)	42.9	(1.69)
150-22-12	5/8 & 3/4	5.11	(.201)	53.8	(2.12)
150-22-16	1	5.11	(.201)	60.5	(2.38)
150-22-20	1 1/4	5.11	(.201)	66.5	(2.62)
5100-22-245	1 1/2	5.11	(.201)	82.6	(3.25)

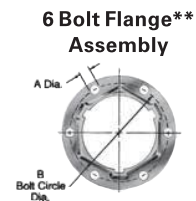

*To order caps and plugs without chain, order cap by part number 5100-32-(size) and plug by part number 5100-41-(size).

**6 Bolt Flange-holes equally spaced. (See "A" for bolt hole diameter, and "B" for bolt circle diameter).

PNEUMATIC

SPECIAL APPLICATIONS

DIAGNOSTIC

AGRICULTURE

REFRIGERANT

FD85 Series Thread to Connect



The Eaton FD85 Series is a thread to connect coupling most commonly used in Oil and Gas applications, but can also be found on demanding applications on both mobile and stationary equipment where operating pressures of 5,000 psi are present.

Product Features

- Thread to connect feature allows for use in high vibration and impulse applications.
- Standard body material: Zinc trivalent plated carbon steel. Stainless steel construction available upon request.
- Connect under residual pressure capability.
- Standard seal material: Buna-N. FKM seals are available upon request.
- Wing nut and wrench flat design allows for easy connection and disconnection.
- 3/4" design is offered in a hex nut design.
- Female NPTF thread ends are standard and BSPP ends are available upon request.

Physical Characteristics

Body Size	Maximum Operating Pressure						Minimum Burst Pressure						Rated Flow		Fluid Loss	Air Inclusion
	Connected	Plug/ Male Half		Socket/ Female Half		Connected	Plug/ Male Half		Socket/ Female Half		L/min	gpm				
(in)	bar	psi	bar	psi	bar	psi	bar	psi	bar	psi	bar	psi			ml-cc.	ml-cc.
3/4"	345	5,000	345	5,000	345	5,000	1,380	20,000	1,380	20,000	1,380	20,000	100	26.4	10	10
1"	345	5,000	345	5,000	345	5,000	1,380	20,000	1,380	20,000	1,380	20,000	189	50	20	26
1 1/4"	345	5,000	345	5,000	345	5,000	1,035	15,000	1,035	15,000	1,035	15,000	288	76	20	40
1 1/2"	345	5,000	345	5,000	345	5,000	1,035	15,000	1,035	15,000	1,035	15,000	379	100	83	85
2"	345	5,000	345	5,000	345	5,000	1,035	15,000	1,035	15,000	1,035	15,000	757	200	181	240

Applications & Markets

- Oilfields
- Offshore Drilling
- Construction
- Oil and Gas

Lloyd's Register Certification

The FD85 Series carries a Lloyd's Registry Certificate for fire conditions outlined in API 16D and EUB Directive 36. These parts meet the requirements that couplings shall be capable of maintaining pressure when exposed to a 700°C (1,300°F) temperature for a five-minute period in connected state.

Certification only applies to those assemblies where both mating parts socket/female and plug/male are Eaton FD85 Series thread to connect couplings.

Flow Data

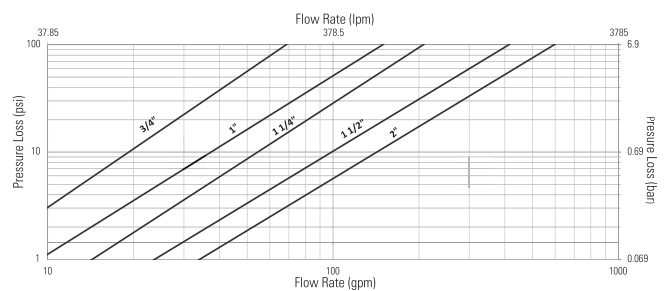

FD85 Series Thread to Connect

FLUID TRANSFER
AND HYDRAULIC

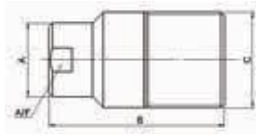

Figure 1

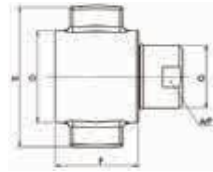

Figure 2

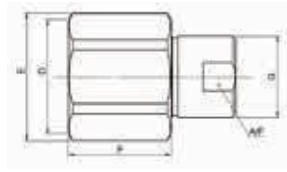

Figure 3

Plugs (Male)

Part Number	Body Size	Thread Size		Fig.	Dimensions									Weight	
		NPT	BSPP		A (in)	B (in)	C (in)	A (mm)	B (mm)	C (mm)	A/F (in)	A/F (mm)	Lbs	grams	
FD85-1001-12-12	3/4	3/4-14		1	1.39	3.27	1.74	35.2	83.1	44.3	11/3	33	1.162	480	
FD85-1017-12-12	3/4		G 3/4-14	1	1.39	3.27	1.74	35.2	83.1	44.3	11/3	33	1.162	480	
FD85-1001-16-16	1	1-11 1/2		1	1.77	4.17	2.25	45	106	57.1	15/8	41	2.921	1120	
FD85-1017-16-16	1		G 1 - 11	1	1.77	4.17	2.25	45	106	57.1	15/8	41	2.974	1120	
FD85-1001-20-20	1 1/4	1 1/4 - 11		1	2.15	5.37	2.62	54.5	136.4	66.6	2	50	5.633	1875	
FD85-1017-20-20	1 1/4		G 1 1/4 - 11	1	2.15	5.37	2.62	54.5	136.4	66.6	2	50	5.633	1875	
FD85-1001-24-24	1 1/2	1 1/2-11 1/2		1	2.5	5.99	3.25	63.5	152.2	82.55	23/8	60	7.721	3150	
FD85-1017-24-24	1 1/2		G 1 1/2 - 11	1	2.5	5.99	3.25	63.5	152.2	82.55	23/8	60	7.721	3150	
FD85-1001-32-32	2	2 - 11 1/2		1	3.25	7	4	82.5	179.2	101.6	3	76	15.046	5635	
FD85-1017-32-32	2		G 2" - 11	1	3.25	7	4	82.5	179.2	101.6	3	76	15.046	5635	

Sockets (Female)

Part Number	Body Size	Thread Size		Fig.	Dimensions									Weight		
		NPT	BSPP		D (in)	E (in)	F (in)	G (in)	D (mm)	E (mm)	F (mm)	G (mm)	A/F (in)	A/F (mm)	Lbs	grams
FD85-1003-12-12	3/4	3/4-14		3	1.94	2.17	1.74	1.39	49.2	55	44.3	35.2	11/3	33	1.162	527
FD85-1019-12-12	3/4		G 3/4-14	3	1.94	2.17	1.74	1.39	49.2	55	44.3	35.2	11/3	33	1.162	527
FD85-1003-16-16	1	1-11 1/2		2	2.68	4.25	2.2	1.77	68	108	56	45	15/8	41	2.921	1325
FD85-1019-16-16	1		G 1 - 11	2	2.68	4.25	2.2	1.77	68	108	56	45	15/8	41	2.974	1349
FD85-1003-20-20	1 1/4	1 1/4 - 11		2	3.15	4.72	2.8	2.15	80	120	71	54.5	2	50	5.633	2555
FD85-1019-20-20	1 1/4		G 1 1/4 - 11	2	3.15	4.72	2.8	2.15	80	120	71	54.5	2	50	5.633	2555
FD85-1003-24-24	1 1/2	1 1/2-11 1/2		2	3.66	5.67	3.31	2.5	93	144	84	63.5	23/8	60	7.721	3502
FD85-1019-24-24	1 1/2		G 1 1/2 - 11	2	3.66	5.67	3.31	2.5	93	144	84	63.5	23/8	60	7.721	3502
FD85-1003-32-32	2	2 - 11 1/2		2	4.67	6.67	4.35	3.25	118.6	169.4	110.5	82.5	3	76	15.046	6825
FD85-1019-32-32	2		G 2" - 11	2	4.67	6.67	4.35	3.25	118.6	169.4	110.5	82.5	3	76	15.046	6825

Complete Sets

Part Number	Coupling Type	Body Size	Thread	Fig.
FD85-1000-12-12	Complete	3/4	3/4-14 NPTF	1 & 3
FD85-1016-12-12	Complete	3/4	3/4-14 BSPP	1 & 3
FD85-1000-16-16	Complete	1	1 1/2-11 NPTF	1 & 2
FD85-1016-16-16	Complete	1	1 1/2 BSPP	1 & 2
FD85-1000-20-20	Complete	1 1/4	1 1/4 - 11 NPTF	1 & 2
FD85-1016-20-20	Complete	1 1/4	1 1/4 - 11 BSPP	1 & 2
FD85-1000-24-24	Complete	1 1/2	1 1/2-11 NPTF	1 & 2
FD85-1016-24-24	Complete	1 1/2	1 1/2-11 BSPP	1 & 2
FD85-1000-32-32	Complete	2	2 - 11 NPTF	1 & 2
FD85-1016-32-32	Complete	2	2 - 11 BSPP	1 & 2

PNEUMATIC

SPECIAL APPLICATIONS

DIAGNOSTIC

AGRICULTURE

REFRIGERANT

FD86 Series

Thread to Connect

5,000 psi Dry Break – High Impulse



Eaton's FD86 Series is a thread together steel quick coupling offering dry break and high impulse technology and capabilities. The maximum operating pressure is 5,000 psi. The FD86 Series is available in either wing nut or hex nut configurations for ease of assembly and disassembly. (For higher pressure applications and additional size requirements, refer to FD96 on page 43.)

Product Features

- Tubular valve and sleeve construction for low fluid loss and air inclusion
- Thread together design using wing or hex nut allows connection and disconnection against pressures up to 750 psi
- Teflon* back-up rings along with secondary metal-to-metal sealing contact provides high impulse capability up to 5,000 psi operating pressure
- Acme threads prevent galling and provide ease of connection
- Steel flange available for bulkhead mounting
- Standard seal material: Buna-N
- Standard body material: High resistance carbon steel with zinc trivalent plating

Physical Characteristics

Body Size (in)	Max. Operating Pressure		Min. Burst Pressure		Vacuum Connected Only (in./Hg)	Rated Flow		Air Inclusion cc. max.	Fluid Loss cc.max.
	(bar)	(psi)	(bar)	(psi)		(lpm)	(gpm)		
1	345	5,000	1,034	15,000	28	189	50	2.90	0.72
1 1/4	345	5,000	1,034	15,000	28	284	75	4.61	1.00

Applications & Markets

- Hydraulic and fluid transfer
- Mining equipment

Flow Data

Pressure Drop Versus Flow Graph

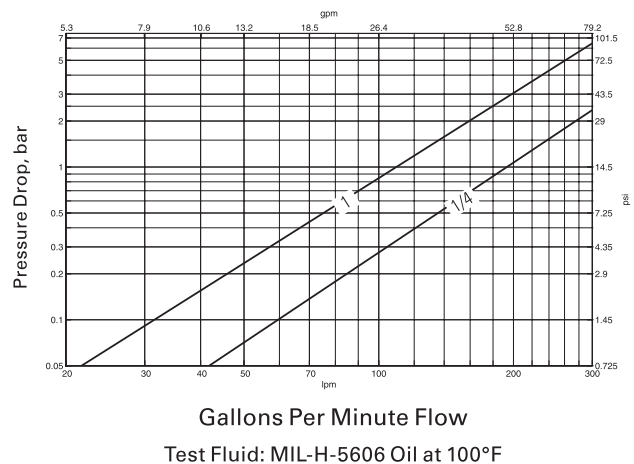

FD86 Series

Thread to Connect

5,000 psi Dry Break – High Impulse

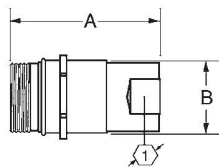

Figure 1

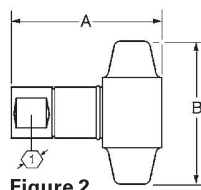

Figure 2

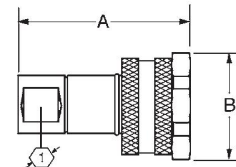

Figure 3

Dimensions (Female SAE O-Ring)

Part Number	Buna-N	FKM	EPDM	Type	Body Size	Port Size	Thread	Type	Fig.	Dimensions			Hex [Ⓜ]	
										Fig. A	Dimensions B	mm	(in)	mm
FD86-1008-16-16	FD86-1043-16-16	FD86-1053-16-16	Plug/Male	1	1 5/16	1 5/16 - 12	Female SAE O-Ring	1	102.4	(4.03)	53.6	(2.11)	44.5	(1.75)
FD86-1010-16-16	FD86-1044-16-16	FD86-1054-16-16	Socket/Female	1	1 5/16	1 5/16 - 12	Female SAE O-Ring	2	117.3	(4.62)	114.3	(4.50)	-	-
FD86-1006-16-16	FD86-1042-16-16	FD86-1052-16-16	Socket/Female	1	1 5/16	1 5/16 - 12	Female SAE O-Ring	3	117.3	(4.62)	71.4	(2.81)	15.8	(1.62)
FD86-1008-20-20	FD86-1043-20-20	FD86-1053-20-20	Plug/Male	1 1/4	1 5/8	1 5/8 - 12	Female SAE O-Ring	1	105.7	(4.16)	63.0	(2.48)	57.2	(2.25)
FD86-1010-20-20	FD86-1044-20-20	FD86-1054-20-20	Socket/Female	1 1/4	1 5/8	1 5/8 - 12	Female SAE O-Ring	2	132.6	(5.22)	133.4	(5.25)	-	-
FD86-1006-20-20	FD86-1042-20-20	FD86-1052-20-20	Socket/Female	1 1/4	1 5/8	1 5/8 - 12	Female SAE O-Ring	3	132.6	(5.22)	86.4	(3.40)	50.8	(2.00)

Dimensions (Female NPT)

Part Number	Buna-N	FKM	EPDM	Type	Body Size	Port Size	Thread	Type	Fig.	Dimensions			Hex [Ⓜ]	
										Fig. A	Dimensions B	mm	(in)	mm
FD86-1002-16-16	FD86-1040-16-16	FD86-1050-16-16	Plug/Male	1	1 - 11 1/2	1 - 11 1/2	Female NPT	1	111.8	(4.40)	53.6	(2.11)	44.5	(1.75)
FD86-1001-16-16	FD86-1039-16-16	FD86-1049-16-16	Socket/Female	1	1 - 11 1/2	1 - 11 1/2	Female NPT	2	126.5	(4.98)	114.3	(4.50)	-	-
FD86-1004-16-16	FD86-1041-16-16	FD86-1051-16-16	Socket/Female	1	1 - 11 1/2	1 - 11 1/2	Female NPT	3	126.5	(4.98)	71.4	(2.81)	15.8	(1.62)
FD86-1002-20-20	FD86-1040-20-20	FD86-1050-20-20	Plug/Male	1 1/4	1 1/4 - 11 1/2	1 1/4 - 11 1/2	Female NPT	1	112.5	(4.43)	63.0	(2.48)	57.2	(2.25)
FD86-1001-20-20	FD86-1039-20-20	FD86-1049-20-20	Socket/Female	1 1/4	1 1/4 - 11 1/2	1 1/4 - 11 1/2	Female NPT	2	142.8	(5.62)	133.4	(5.25)	-	-
FD86-1004-20-20	FD86-1041-20-20	FD86-1051-20-20	Socket/Female	1 1/4	1 1/4 - 11 1/2	1 1/4 - 11 1/2	Female NPT	3	142.8	(5.62)	86.4	(3.40)	50.8	(2.00)

Repair Kits

Part Number	Buna-N	FKM	EPDM	Body Size	Coupling Type
FF10596-16	FF10596-16	FF10597-16	FF10598-16	1	Male
FF10593-16	FF10593-16	FF10594-16	FF10595-16	1	Female
FF10596-20	FF10596-20	FF10597-20	FF10598-20	1 1/4	Male
FF10593-20	FF10593-20	FF10594-20	FF10595-20	1 1/4	Female

Dust Caps and Dust Plugs

Part Number	Dust Cap with Chain	Dust Plug with Chain	Body Size
FD86-1018-16	FD86-1018-16	FD86-1016-16	1
FD86-1018-20	FD86-1018-20	FD86-1016-20	1 1/4

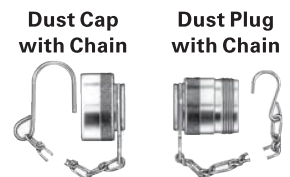

Um nome carregado de soluções

W6000 Series (Steel) Thread-to-Connect



Eaton's W6000 Series steel quick disconnect coupling is a screw-to-connect with a rugged construction. It remains the series users refer to when it deals with severe hydraulic applications such as construction and mining. The design and materials used give this quick disconnect coupling resistance to heavy mechanical loads. Most common examples are ram loads, hydraulic shocks, and severe pulsating pressures.

Product Features

- Proprietary profile
- Thread-to-connect with double shut-off valving
- Optional dust caps and plugs (made of anodized aluminum)
- Can be connected under residual pressure
- Standard body material: Zinc trivalent plated steel
- Standard seal material: NBR, FKM, EPDM

European Pressure Equipment Directive

Couplings with nominal diameters up to and including 25 mm are designed and manufactured under Article 3.3 of the European Pressure Equipment Directive 97/23 EC. Couplings with nominal diameters greater than 25 mm are designed and manufactured in accordance with the stipulations of Module A of the European Pressure Equipment Directive 97/23 EC. They should not be used to convey unstable gases.
Group 1 = Hazardous media / Group 2 = Other media

Physical Characteristics

Body Size	Nominal Flow Diameter	Max. Operating Pressure* Non hazardous liquids & gases in Group 2		Maximum Residual Pressure during Connection*** Non Hazardous liquids & gases in Group 1		Maximum Residual Pressure during Connection***		Rated Flow**		Fluid Loss
		(bar)	(psi)	(bar)	(psi)	(bar)	(psi)	(lpm)	(gpm)	
¼	5.7	1,100	15,950	1,100	15,950	30	435	11.6	3.06	1.1
⅜	7.6	750	10,875	750	10,875	30	435	16.7	4.41	1.9
½	10.3	750	10,875	750	10,875	30	435	25.5	6.74	2.8
¾	14.2	650	9,425	650	9,425	50	725	55	14.53	5.8
1	16.5	450	6,525	450	6,525	30	435	87	22.98	10.9
1¼	20.5	450	6,525	450	6,525	30	435	140	36.98	26.9
1½	25.8	300	4,350	38	550	30	435	208	54.95	37.5
2	34.7	300	4,350	28	405	30	435	357	94.30	81

* For pulsating pressures when disconnected apply a multiplier of 0.5
 ** Indicated values refer to a 1 bar/14.5 psi pressure drop.
 *** When connecting under pressure, the socket nut thread must be lubricated.

Applications & Markets

- Construction
- Oil & Gas
- Material handling
- All industrial and severe applications
- Systems subject to heavy mechanical loads, high pressures

Flow Data

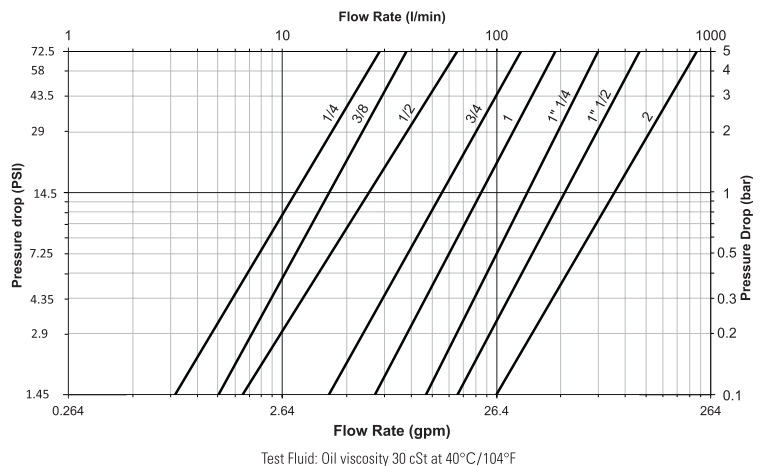

Seal Elastomer Data*

Seal Elastomer	Max. Operation Temperature Range
NBR (Nitrile)	-20°C +100°C/-4°F +212°F
FKM	-20°C +200°C/-4°F +392°F
EPDM (Ethylene-Propylene)	-40°C +150°C/-40°F +302°F

* For reference only, based on Eaton recommended temperatures.
 Contact Eaton technical support for further information on fluid compatibility.

FLUID TRANSFER AND HYDRAULIC
 PNEUMATIC
 SPECIAL APPLICATIONS
 DIAGNOSTIC
 AGRICULTURE
 REFRIGERANT

W6000 Series (Steel) Thread-to-Connect

FLUID TRANSFER
AND HYDRAULIC

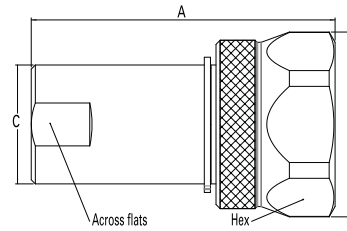

Figure 1

Sockets (Female)

Part Number			Body Size (in)	Nominal Flow Diameter (mm)	Thread Size* (Female)			Dimensions						Weight						
NBR	FKM	EPDM			NPT	BSPP	Metric	Fig. A (in)	B (in)	C (in)	Across Flats (in)	Hex (in)	A (mm)	B (mm)	C (mm)	Across Flats (mm)	Hex (mm)	lbs	grams	
WA0601700	WA06017V0	WA06017E0	¼	5.7	-	¼-19	-	1	2.09	1.38	0.83	0.75	1.26	53	35	21	19	32	0.32	144
WA0621700	WA06217V0	WA06217E0	¼	5.7	¼-18	-	-	1	2.09	1.38	0.83	0.75	1.26	53	35	21	19	32	0.32	144
WA0602700	WA06027V0	WA06027E0	⅜	7.6	-	⅜-19	-	1	2.56	1.50	0.98	0.90	1.38	65	38	25	23	35	0.48	217
WA0622700	WA06227V0	WA06227E0	⅜	7.6	⅜-18	-	-	1	2.56	1.50	0.98	0.90	1.38	65	38	25	23	35	0.48	217
WA0603700	WA06037V0	WA06037E0	½	10.3	-	½-14	-	1	2.91	1.77	1.14	1.06	1.61	74	45	29	27	41	0.71	320
WA0623700	WA06237V0	WA06237E0	½	10.3	½-14	-	-	1	2.91	1.77	1.14	1.06	1.61	74	45	29	27	41	0.71	320
WA0633700	WA06337V0	WA06337E0	½	10.3	-	-	M22x1.5	1	2.91	1.77	1.14	1.06	1.61	74	45	29	27	41	0.71	320
WA0604700	WA06047V0	WA06047E0	¾	14.2	-	¾-14	-	1	3.58	2.16	1.50	1.38	1.97	91	55	38	35	50	1.32	600
WA0624700	WA06247V0	WA06247E0	¾	14.2	¾-14	-	-	1	3.58	2.16	1.50	1.38	1.97	91	55	38	35	50	1.32	600
WA0605700	WA06057V0	WA06057E0	1	16.5	-	1-11	-	1	4.05	2.72	1.81	1.61	2.56	103	69	46	41	65	2.41	1092
WA0625700	WA06257V0	WA06257E0	1	16.5	1-11½	-	-	1	4.05	2.72	1.81	1.61	2.56	103	69	46	41	65	2.41	1092
WA0635700	WA06357V0	WA06357E0	1	16.5	-	-	M33x1.5	1	4.05	2.72	1.81	1.61	2.56	103	69	46	41	65	2.41	1092
WA0606700	WA06067V0	WA06067E0	1¼	20.5	-	1¼-11	-	1	5.71	3.50	2.36	2.16	3.03	145	89	60	55	77	6.13	2780
WA0626700	WA06267V0	WA06267E0	1¼	20.5	1¼-11½	-	-	1	5.71	3.50	2.36	2.16	3.03	145	89	60	55	77	6.13	2780
WA0607700	WA06077V0	WA06077E0	1½	25.8	-	1½-11	-	1	6.81	3.94	2.64	2.48	3.46	173	100	67	63	88	9.26	4200
WA0627700	WA06277V0	WA06277E0	1½	25.8	1½-11½	-	-	1	6.81	3.94	2.64	2.48	3.46	173	100	67	63	88	9.26	4200
WA0609700	WA06097V0	WA06097E0	2	34.7	-	2-11	-	1	8.07	4.60	3.07	2.80	4.13	205	117	78	71	105	14.64	6640
WA0629700	WA06297V0	WA06297E0	2	34.7	2-11½	-	-	1	8.07	4.60	3.07	2.80	4.13	205	117	78	71	105	14.64	6640

* Alternative end connections available upon request.

To obtain connected length of coupling add dimensions A (Fig.1) and G (Fig. 2) together.

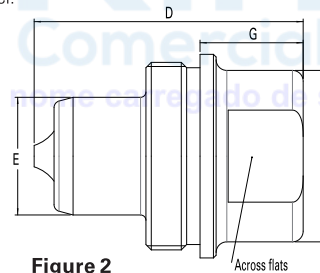

Figure 2

Plugs (Male)

Part Number			Body Size (in)	Nominal Flow Diameter (mm)	Thread Size* (Female)			Dimensions						Weight						
NBR	FKM	EPDM			NPT	BSPP	Metric	Fig. D (in)	E (in)	F (in)	G (in)	Across Flats (in)	D (mm)	E (mm)	F (mm)	G (mm)	Across Flats (mm)	lbs	grams	
WA0601400	WA06014V0	WA06014E0	¼	5.7	-	¼-19	-	2	1.38	0.59	0.90	0.45	0.75	35	15	23	11.5	19	0.16	71
WA0621400	WA06214V0	WA06214E0	¼	5.7	¼-18	-	-	2	1.38	0.59	0.90	0.45	0.75	35	15	23	11.5	19	0.16	71
WA0602400	WA06024V0	WA06024E0	⅜	7.6	-	⅜-19	-	2	1.65	0.75	1.02	0.52	0.90	42	19	26	13	23	0.23	104
WA0622400	WA06224V0	WA06224E0	⅜	7.6	⅜-18	-	-	2	1.65	0.75	1.02	0.52	0.90	42	19	26	13	23	0.23	104
WA0603400	WA06034V0	WA06034E0	½	10.3	-	½-14	-	2	1.97	0.87	1.26	0.77	1.06	50	22	32	19.5	27	0.36	165
WA0623400	WA06234V0	WA06234E0	½	10.3	½-14	-	-	2	1.97	0.87	1.26	0.77	1.06	50	22	32	19.5	27	0.36	165
WA0633400	WA06334V0	WA06334E0	½	10.3	-	-	M22x1.5	2	1.97	0.87	1.26	0.77	1.06	50	22	32	19.5	27	0.36	165
WA0604400	WA06044V0	WA06044E0	¾	14.2	-	¾-14	-	2	2.48	1.14	1.65	1.02	1.38	63	29	42	26	35	0.84	382
WA0624400	WA06244V0	WA06244E0	¾	14.2	¾-14	-	-	2	2.48	1.14	1.65	1.02	1.38	63	29	42	26	35	0.84	382
WA0605400	WA06054V0	WA06054E0	1	16.5	-	1-11	-	2	2.80	1.42	1.89	1.14	1.61	71	36	48	29	41	1.29	585
WA0625400	WA06254V0	WA06254E0	1	16.5	1-11½	-	-	2	2.80	1.42	1.89	1.14	1.61	71	36	48	29	41	1.29	585
WA0635400	WA06354V0	WA06354E0	1	16.5	-	-	M33x1.5	2	2.80	1.42	1.89	1.14	1.61	71	36	48	29	41	1.29	585
WA0606400	WA06064V0	WA06064E0	1¼	20.5	-	1¼-11	-	2	3.82	2.00	2.36	1.45	2.16	97	50.9	60	37	55	3.22	1460
WA0626400	WA06264V0	WA06264E0	1¼	20.5	1¼-11½	-	-	2	3.82	2.00	2.36	1.45	2.16	97	50.9	60	37	55	3.22	1460
WA0607400	WA06074V0	WA06074E0	1½	25.8	-	1½-11	-	2	4.29	2.24	2.64	1.22	2.48	109	56.9	67	31	63	4.50	2040
WA0627400	WA06274V0	WA06274E0	1½	25.8	1½-11½	-	-	2	4.29	2.24	2.64	1.22	2.48	109	56.9	67	31	63	4.50	2040
WA0609400	WA06094V0	WA06094E0	2	34.7	-	2-11	-	2	5.08	2.73	3.07	1.32	2.80	129	69.4	78	33	71	7.05	3200
WA0629400	WA06294V0	WA06294E0	2	34.7	2-11½	-	-	2	5.08	2.73	3.07	1.32	2.80	129	69.4	78	33	71	7.05	3200

* Alternative end connections available upon request.

To obtain connected length of coupling add dimensions A (Fig.1) and G (Fig. 2) together.

PNEUMATIC

SPECIAL APPLICATIONS

DIAGNOSTIC

AGRICULTURE

REFRIGERANT

W6000 Series (Steel) Thread-to-Connect

Dust Plugs and Dust Caps

Body Size	Socket Dust Plug Part Number	Plug Dust Cap Part Number
(in)	Anodized Aluminum	Anodized Aluminum
¼	WD0611700	WD0611400
⅜	WD0612700	WD0612400
½	WD0613700	WD0613400
¾	WD0614700	WD0614400
1	WD0615700	WD0615400
1¼	WD0616700	WD0616400
1½	WD0617700	WD0617400
2	WD0619700	WD0619400



FLUID TRANSFER
AND HYDRAULIC

PNEUMATIC

SPECIAL APPLICATIONS

DIAGNOSTIC

AGRICULTURE

REFRIGERANT

W6000 Series (Stainless Steel) Thread-to-Connect



Eaton's W6000 Series stainless steel quick disconnect coupling is a thread-to-connect with a rugged construction. This quick disconnect coupling utilizes 1.4418 grade stainless steel, which guarantees the same mechanical resistance as the steel version while offering excellent resistance in corrosive environments. It remains the coupling of choice in offshore oil & gas applications but also covers a wide range of alternative hydraulic applications.

Product Features

- Proprietary profile
- Thread-to-connect with double shut-off valving
- Resistance to heavy mechanical loads (hydraulic shocks, severe pulsating pressures, etc.).
- Optional dust caps and plugs (made of anodized aluminum)
- Can be connected under residual pressure
- Standard seal material: FKM, EPDM
- Standard body material: Stainless steel 1.4418 (1.4404 AISI 316L stainless steel available on request at lower operating pressures. Please contact Eaton technical support for further information)

European Pressure Equipment Directive

Couplings with nominal diameters up to and including 25 mm are designed and manufactured under Article 3.3 of the European Pressure Equipment Directive 97/23 EC. Couplings with nominal diameters greater than 25 mm are designed and manufactured in accordance with the stipulations of Module A of the European Pressure Equipment Directive 97/23 EC. They should not be used to convey unstable gases. Group 1 = Hazardous media / Group 2 = Other media

Physical Characteristics

Body Size (in)	Nominal Flow Diameter (mm)	Max. Operating Pressure*				Maximum Residual Pressure during Connection***		Rated Flow**		Fluid Loss ml-cc.
		Non hazardous liquids & gases Group 2		Hazardous liquids & gases Group 1		(bar)	(psi)	(lpm)	(gpm)	
¼	5.7	1,100	15,950	1,100	15,950	30	435	11.6	3.06	1.1
⅜	7.6	750	10,875	750	10,875	30	435	16.7	4.41	1.9
½	10.3	750	10,875	750	10,875	30	435	25.5	6.74	2.8
¾	14.2	650	9,425	650	9,425	50	725	55	14.53	5.8
1	16.5	450	6,525	450	6,525	30	435	87	22.98	10.9
1¼	20.5	450	6,525	450	6,525	30	435	140	36.98	26.9
1½	25.8	300	4,350	38	550	30	435	208	54.95	37.5
2	34.7	300	4,350	28	405	30	435	357	94.30	81.0

* For pulsating pressures when disconnected apply a multiplier of 0.5
 ** Indicated values refer to a 1 bar/14.5 psi pressure drop.
 *** When connecting under pressure, the socket nut thread must be lubricated.

Applications & Markets

- Construction
- Oil & Gas
- Material handling
- All industrial and severe applications
- Systems subject to heavy mechanical loads, high pressures

Flow Data

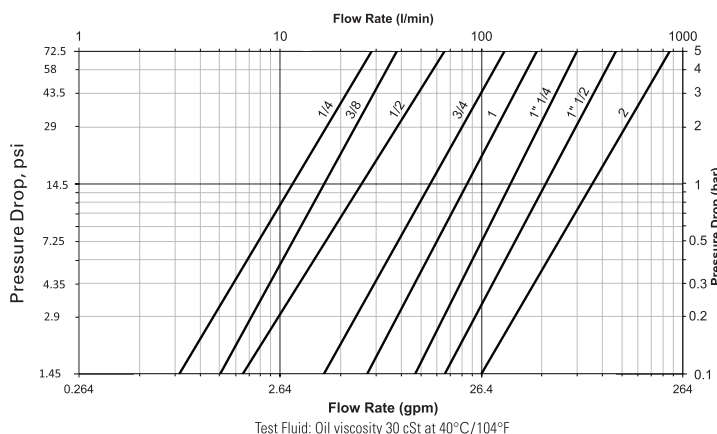

Seal Elastomer Data*

Seal Elastomer	Max. Operation Temperature Range
FKM	-20°C +200°C/-4°F +392°F
EPDM (Ethylene-Propylene)	-40°C +150°C/-40°F +302°F

* For reference only, based on Eaton recommended temperatures. Contact Eaton technical support for further information on fluid compatibility.

W6000 Series (Stainless Steel) Thread-to-Connect

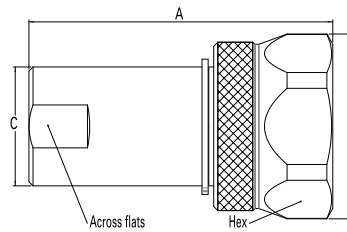

Figure 1

Sockets (Female)

Part Number*		Body Size	Nominal Flow Diameter		Thread Size** (Female)		Dimensions										Weight	
FKM	EPDM		(in)	(mm)	NPT	BSPP	Fig. A (in)	B (in)	C (in)	Across Flats (in)	Hex (in)	A (mm)	B (mm)	C (mm)	Across Flats (mm)	Hex (mm)	lbs	grams
WV06017V0	WV06017E0	¼	5.7	-	¼-19	1	2.09	1.38	0.83	0.75	1.26	53	35	21	19	32	0.32	144
WV06217V0	WV06217E0	¼	5.7	¼-18	-	1	2.09	1.38	0.83	0.75	1.26	53	35	21	19	32	0.32	144
WV06027V0	WV06027E0	⅜	7.6	-	⅜-19	1	2.56	1.50	0.98	0.90	1.38	65	38	25	23	35	0.48	217
WV06227V0	WV06227E0	⅜	7.6	⅜-18	-	1	2.56	1.50	0.98	0.90	1.38	65	38	25	23	35	0.48	217
WV06037V0	WV06037E0	½	10.3	-	½-14	1	2.91	1.77	1.14	1.06	1.61	74	45	29	27	41	0.71	320
WV06237V0	WV06237E0	½	10.3	½-14	-	1	2.91	1.77	1.14	1.06	1.61	74	45	29	27	41	0.71	320
WV06047V0	WV06047E0	¾	14.2	-	¾-14	1	3.58	2.16	1.50	1.38	1.97	91	55	38	35	50	1.32	600
WV06247V0	WV06247E0	¾	14.2	¾-14	-	1	3.58	2.16	1.50	1.38	1.97	91	55	38	35	50	1.32	600
WV06057V0	WV06057E0	1	16.5	-	1-11	1	4.05	2.72	1.81	1.61	2.56	103	69	46	41	65	2.41	1092
WV06257V0	WV06257E0	1	16.5	1-11½	-	1	4.05	2.72	1.81	1.61	2.56	103	69	46	41	65	2.41	1092
WV06067V0	WV06067E0	1¼	20.5	-	1¼-11	1	5.71	3.50	2.36	2.16	3.03	145	89	60	55	77	6.13	2780
WV06267V0	WV06267E0	1¼	20.5	1¼-11½	-	1	5.71	3.50	2.36	2.16	3.03	145	89	60	55	77	6.13	2780
WV06077V0	WV06077E0	1½	25.8	-	1½-11	1	6.81	3.94	2.64	2.48	3.46	173	100	67	63	88	9.26	4200
WV06277V0	WV06277E0	1½	25.8	1½-11½	-	1	6.81	3.94	2.64	2.48	3.46	173	100	67	63	88	9.26	4200
WV06097V0	WV06097E0	2	34.7	-	2-11	1	8.07	4.60	3.07	2.80	4.13	205	117	78	71	105	14.64	6640
WV06297V0	WV06297E0	2	34.7	2-11½	-	1	8.07	4.60	3.07	2.80	4.13	205	117	78	71	105	14.64	6640

* 1.4404 AISI 316L stainless steel available on request. Please contact Eaton technical support for further information.

** Alternative end connections available upon request.

To obtain connected length of coupling add dimensions A (Fig.1) and G (Fig. 2) together.

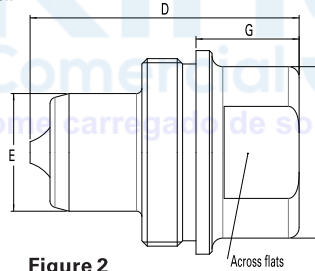

Figure 2

Plugs (Male)

Part Number*		Body Size	Nominal Flow Diameter		Thread Size** (Female)		Dimensions										Weight	
FKM	EPDM		(in)	(mm)	NPT	BSPP	Fig. D (in)	E (in)	F (in)	G (in)	Across Flats (in)	D (mm)	E (mm)	F (mm)	G (mm)	Across Flats (mm)	lbs	grams
WV06014V0	WV06014E0	¼	5.7	-	¼-19	2	1.38	0.59	0.90	0.45	0.75	35	15	23	11.5	19	0.16	71
WV06214V0	WV06214E0	¼	5.7	¼-18	-	2	1.38	0.59	0.90	0.45	0.75	35	15	23	11.5	19	0.16	71
WV06024V0	WV06024E0	⅜	7.6	-	⅜-19	2	1.65	0.75	1.02	0.52	0.90	42	19	26	13	23	0.23	104
WV06224V0	WV06224E0	⅜	7.6	⅜-18	-	2	1.65	0.75	1.02	0.52	0.90	42	19	26	13	23	0.23	104
WV06034V0	WV06034E0	½	10.3	-	½-14	2	1.97	0.87	1.26	0.77	1.06	50	22	32	19.5	27	0.36	165
WV06234V0	WV06234E0	½	10.3	½-14	-	2	1.97	0.87	1.26	0.77	1.06	50	22	32	19.5	27	0.36	165
WV06044V0	WV06044E0	¾	14.2	-	¾-14	2	2.48	1.14	1.65	1.02	1.38	63	29	42	26	35	0.84	382
WV06244V0	WV06244E0	¾	14.2	¾-14	-	2	2.48	1.14	1.65	1.02	1.38	63	29	42	26	35	0.84	382
WV06054V0	WV06054E0	1	16.5	-	1-11	2	2.80	1.42	1.89	1.14	1.61	71	36	48	29	41	1.29	585
WV06254V0	WV06254E0	1	16.5	1-11½	-	2	2.80	1.42	1.89	1.14	1.61	71	36	48	29	41	1.29	585
WV06064V0	WV06064E0	1¼	20.5	-	1¼-11	2	3.82	2.00	2.36	1.45	2.16	97	50.9	60	37	55	3.22	1460
WV06264V0	WV06264E0	1¼	20.5	1¼-11½	-	2	3.82	2.00	2.36	1.45	2.16	97	50.9	60	37	55	3.22	1460
WV06074V0	WV06074E0	1½	25.8	-	1½-11	2	4.29	2.24	2.64	1.22	2.48	109	56.9	67	31	63	4.50	2040
WV06274V0	WV06274E0	1½	25.8	1½-11½	-	2	4.29	2.24	2.64	1.22	2.48	109	56.9	67	31	63	4.50	2040
WV06094V0	WV06094E0	2	34.7	-	2-11	2	5.08	2.73	3.07	1.32	2.80	129	69.4	78	33.5	71	7.05	3200
WV06294V0	WV06294E0	2	34.7	2-11½	-	2	5.08	2.73	3.07	1.32	2.80	129	69.4	78	33.5	71	7.05	3200

* 1.4404 AISI 316L stainless steel available on request. Please contact Eaton technical support for further information.

** Alternative end connections available upon request.

To obtain connected length of coupling add dimensions A (Fig.1) and G (Fig. 2) together.

FLUID TRANSFER AND HYDRAULIC

PNEUMATIC

SPECIAL APPLICATIONS

DIAGNOSTIC

AGRICULTURE

REFRIGERANT

W6000 Series (Stainless Steel) Thread-to-Connect

Dust Plugs and Dust Caps

Body Size	Socket Dust Plug Part Number	Plug Dust Cap Part Number
(in)	Anodized Aluminum	Anodized Aluminum
¼	WD0611700	WD0611400
⅜	WD0612700	WD0612400
½	WD0613700	WD0613400
¾	WD0614700	WD0614400
1	WD0615700	WD0615400
1¼	WD0616700	WD0616400
1½	WD0617700	WD0617400
2	WD0619700	WD0619400



HP3 Series



Eaton's HP3 Series Hydraulic Jack/Enerpac Interchange is designed for high pressure applications up to 700 bar (10,000 psi).

Product Features

- Thread together design
- 700 bar (10,000 psi) operating pressure
- Ball valve
- Seal material: Buna-N
- Body material: High resistance carbon steel with zinc trivalent chromate plating

Applications & Markets

- Hydraulic jack
- Portable hydraulic rams

Physical Characteristics

Body Size (in)	Max. Operating Pressure (Static) Connected		Min. Burst Pressure Connected		Rated Flow	
	(bar)	(psi)	(bar)	(psi)	(lpm)	(gpm)
3/8	700	10,000	1,850	26,800	23	6

* Connect and disconnect under pressure not allowed

Dimensions

Part Number	Coupling Type	Body Size	Port Size	Thread	Type	Fig.	Dimensions					
							A		B		Hex	
							mm	(in)	mm	(in)	mm	(in)
HP3SB37M	Socket/Female	3/8	3/8	3/8-18	Male NPT	1	72,2	(2.84)	35,0	(1.38)	24	.94
HP3PB37F	Plug/Male	3/8	3/8	3/8-18	Female NPT	2	40,0	(1.57)	35,0	(1.38)	32	1.26

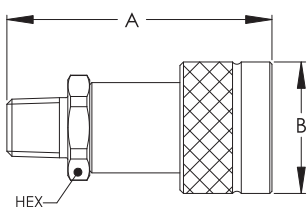

Figure 1

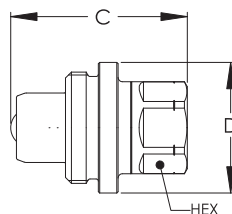

Figure 2

Dust Caps and Dust Plugs

Body Size	Dust Cap	Dust Plug
3/8	WA5612400	WA5612700



W56000 Series



Eaton's W56000 Series is a screw to connect coupling designed to operate at pressures exceeding 10,000 psi or 700 bar. Rugged design makes these couplings suitable for hydraulic jacks and lift loading.

Product Features

- Screw to connect double shut off with poppet valve
- Designed and manufactured under Article 3.3 of the European Pressure Equipment Directive 97/23 EC.
- Interchanges with other couplings with the same profile
- Standard body material: Zinc trivalent plated steel
- Standard seal material: Buna-N

Physical Characteristics

Coupling Size (in)	DN/ND	Max. Operating Pressure		Min. Burst Pressure		Rated Flow		Air Inclusion
		(bar)	(psi)	(bar)	(psi)	(lpm)	(gpm)	ml max
1/4	5.7	700	10,000	2,800	40,000	11	2.9	1.1
3/8	7.6	700	10,000	2,800	40,000	16	4.2	1.9

Applications & Markets

- Hydraulic jacks, Lifts and Emergency Rescue Equipment

Flow Data

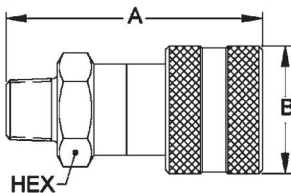
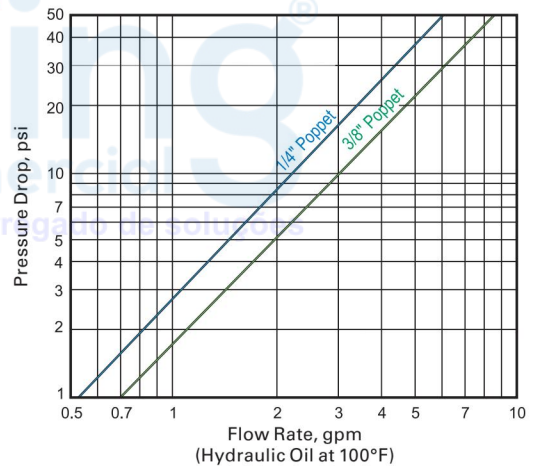

Figure 1

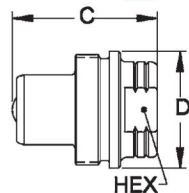

Figure 2

Part Number	DN/ND	Body Size	Coupling Type	Connection	Fig.	Dimensions					
						A (in)	B (in)	Hex (in)	A (mm)	B (mm)	Hex (mm)
WA5651700	5.7	1/4	Socket/Female	1/4 NPT Male	1	2.36	1.12	.88	60	28.5	22
WA5652700	7.6	3/8	Socket/Female	3/8 NPT Male	1	2.76	1.38	1.06	70	35	27

Part Number	DN/ND	Socket/Female	Coupling Type	Connection	Fig.	Dimensions					
						C (in)	D (in)	Hex (in)	C (mm)	D (mm)	Hex (mm)
WA5651400	5.7	1/4	Plug/Male	1/4 NPT Female	2	1.26	1.10	.75	35	15.9	19
WA5652400	7.6	3/8	Plug/Male	3/8 NPT Female	2	1.52	1.26	.91	42	19	23

Dust Caps and Dust Plugs

Body Size	Dust Cap	Dust Plug
1/4	WA5611400	WA5611700
3/8	WA5612400	WA5612700



FLUID TRANSFER AND HYDRAULIC

PNEUMATIC

SPECIAL APPLICATIONS

DIAGNOSTIC

AGRICULTURE

REFRIGERANT

FD35 Series 10,000 psi Ball Latch



Eaton's FD35 Series ball latch has a greater surface contact area for long surface life in rugged high pressure applications. The maximum operating pressure is 10,000 psi.

Product Features

- Safety sleeve lock prevents accidental disconnection
- Heavy duty back-up ring prevents O-Ring extrusion
- Heat treated and plated steel for greater wear and corrosion resistance
- Self-sealing poppet valves provide excellent high and low pressure sealing
- Standard seal material: FKM
- Standard body material: High resistance carbon steel with zinc trivalent plating

Physical Characteristics

Body Size	Max. Operating Pressure		Min. Burst Pressure		Vacuum Connected Only (in./Hg)	Rated Flow		Air Inclusion cc. max.	Fluid Loss cc. max.
	(bar)	(psi)	(bar)	(psi)		(lpm)	(gpm)		
3/8	700	10,000	2,800	40,000	28	8	2	0.50	0.50

Applications & Markets

- 10,000 psi hydraulic applications
- Hydraulic tool
- Hydraulic ram and work loading

Flow Data

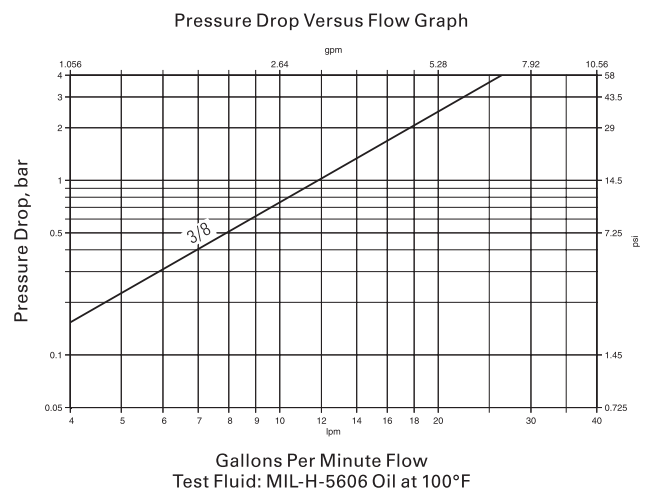

FLUID TRANSFER
AND HYDRAULIC

PNEUMATIC

SPECIAL APPLICATIONS

DIAGNOSTIC

AGRICULTURE

REFRIGERANT

FD35 Series 10,000 psi

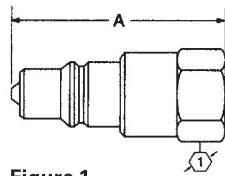

Figure 1

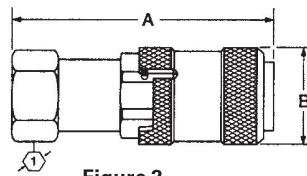

Figure 2

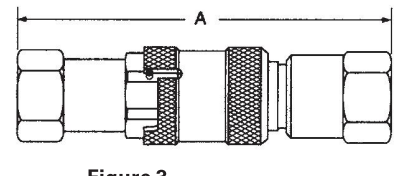

Figure 3

Dimensions (Female NPT, Valved)

Part Number	Coupling Type	Body Size	Port Size	Thread	Type	Fig.	Dimensions					
							A		B		Hex ①	
							mm	(in)	mm	(in)	mm	(in)
FD35-1002-06-06	Plug/Male	3/8	3/8	3/8-18	Female NPT	1	53.8	(2.12)	-	-	23.9	(.94)
FD35-1001-06-06	Socket/Female	3/8	3/8	3/8-18	Female NPT	2	65.0	(2.56)	32.3	(1.27)	23.9	(.94)
FD35-1000-06-06	Complete	3/8	3/8	3/8-18	Female NPT	3	89.9	(3.54)	-	-	-	-

Dimensions (Female SAE O-Ring, Valved)

Part Number	Coupling Type	Body Size	Port Size	Thread	Type	Fig.	Dimensions					
							A		B		Hex ①	
							mm	(in)	mm	(in)	mm	(in)
FD35-1008-06-06	Plug/Male	3/8	9/16	9/16-18	Female SAE O-Ring	1	53.8	(2.12)	-	-	23.9	(.94)
FD35-1007-06-06	Socket/Female	3/8	9/16	9/16-18	Female SAE O-Ring	2	65.0	(2.56)	32.3	(1.27)	23.9	(.94)
FD35-1006-06-06	Complete	3/8	9/16	9/16-18	Female SAE O-Ring	3	89.9	(3.54)	-	-	-	-

Dimensions (Female SAE O-Ring, 125 PSI Bleed Valve)

Part Number	Coupling Type	Body Size	Port Size	Thread	Type	Fig.	Dimensions		Hex ①	
							A			
							mm	(in)	mm	(in)
FD35-1052-06-06	Plug/Male	3/8	9/16	9/16-18	Female SAE O-Ring	1	53.8	(2.12)	23.9	(.94)

Note: Incorporates a special relief valve set at 125 psi, preventing disconnected pressure build-up.

Dust Cap/Plug

Part Number	Body Size
FD35-1042-06	3/8

Note: Fits male and female halves



Dust Cap/Plug

Pneumatic Couplings Selector Chart

Coupling Series	Page	Coupling Style			Interchange				Body Size					Body Material				Locking Mechanism				Options			
		MANUAL CONNECT	PUSH-TO-CONNECT	SAFETY COUPLING	INDUSTRIAL INTERCHANGE	ARO 210/310	TRU-FLATE	CEJN 320/RECTUS 25	HANSEN UNIQUE DESIGN	1/8 INCH	1/4 INCH	3/8 INCH	1/2 INCH	3/4 INCH	ALUMINUM	BRASS	STEEL (Zinc/chromate Finish)	STAINLESS STEEL	PLASTIC (Acetal)	BALL LOCK	PIN LOCK	RING LOCK	PLASTIC FINGERS	SLEEVE LOCK	SEAL MATERIALS (Various)
1000	70	●			●					●					●		●		●				●	●	●
400	74	●			●		●				●				●				●				●	●	●
500	76	●			●							●			●				●				●	●	●
3000	78		●		●					●					●				●		●		●	●	●
4000	82		●		●						●				●				●		●		●	●	●
5000	84		●		●							●			●				●		●		●	●	●
6000	86		●		●							●			●				●		●		●	●	●
Auto-Flo 23	89		●		●	●	●			●					●				●						
Auto-Flo 24	91		●				●			●					●				●						
Safeline	93		●	●	●					●				●		●			●						
180/280	94	●						●		●					●				●					●	
100	96	●						●	●						●				●				●	●	●
600/700	98	●						●		●					●				●				●	●	●
2RL	103		●					●		●						●					●		●	●	●
3RL	106		●					●			●					●					●		●	●	●
Full-Bore	108		●	●	●						●	●				●			●						
210	110		●			●				●						●					●				
310	112		●			●					●					●					●				

▼ Sleeve lock is standard

◆ Polymer Sleeves

FLUID TRANSFER AND HYDRAULIC

PNEUMATIC

SPECIAL APPLICATIONS

DIAGNOSTIC

AGRICULTURE

REFRIGERANT

Pneumatic Couplings One-Way Plug/Male Interchange Chart

FLUID TRANSFER AND HYDRAULIC

The plug/male profiles shown below are actual size. This chart can be used to help select Eaton one-way couplings. The bottom row of this chart and the 180/280 series are unique Eaton plug designs.

PNEUMATIC

SPECIAL APPLICATIONS

DIAGNOSTIC

AGRICULTURE

REFRIGERANT

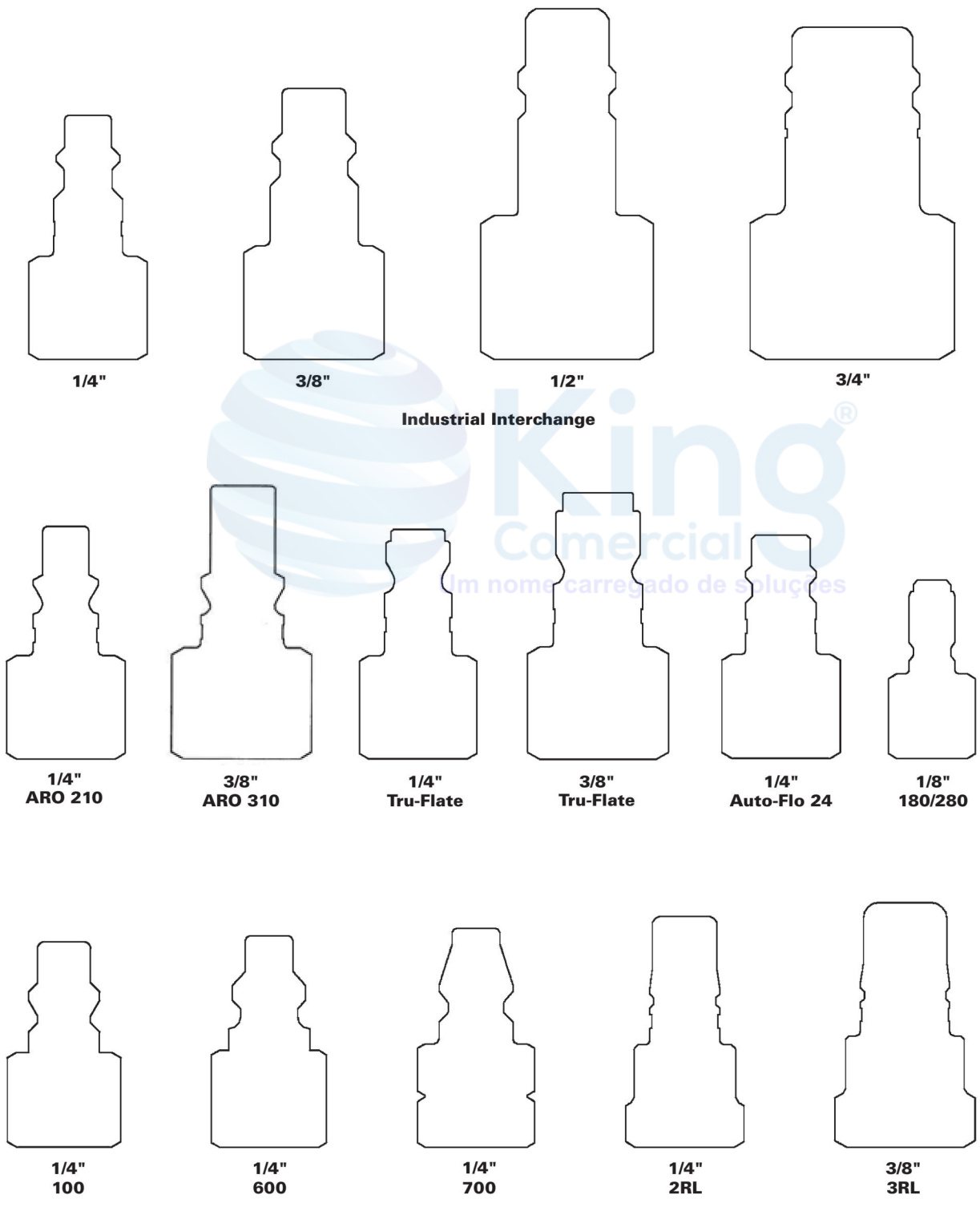

1000/400/500 Series



Eaton's 1000/400/500 Series is an Industrial Interchange pneumatic coupling that is rugged and reliable designed for use with compressed air, gases, and liquids.

Product Features

- Ball latching mechanism
- Optional sleeve lock prevents accidental disconnection
- All sizes accept US Industrial Interchange
- 1/4" & 1/2" accept ISO 6150 B and A-A-59439 plugs/males
- 400 series accepts Tru-Flate Interchange
- Standard body material: Brass with nickel plated steel sleeve
- Standard seal material: Buna-N
- Optional seal materials: Silicone-138, FKM-143, EPDM-192

Physical Characteristics

Series	Body Size	Max. Operating Pressure		Min. Burst Pressure		Rated Flow	
	(in)	(bar)	(psi)	(bar)	(psi)	(lpm)	(gpm)
1000	1/4	138	2,000	552	8,000	679	179
400	3/8	69	1,000	276	4,000	1,274	336
500	1/2	35	500	140	2,000	2,038	538

Applications & Markets

- General Pneumatics
- Construction
- Industrial Plants

Interchangeability

All Sizes	1/4" & 1/2"	400 Series
US Industrial Interchange	ISO 6150 Series B	Tru-Flate
	A-A-59439 (former MIL-C-4109)	

Flow Data

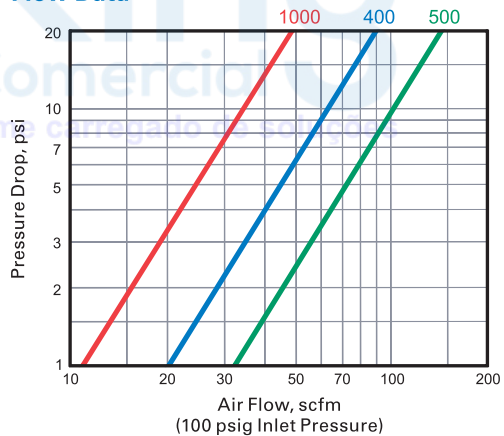

1000 Series

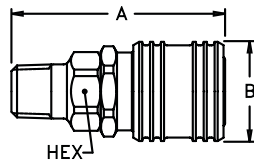

Figure 1

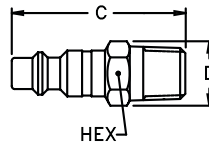

Figure 2

Male NPTF Connections

Part Number	Coupling Type	Body Size	Port Size	Thread	Type	Material	Fig.	Dimensions			A	B	Hex
								A	B	Hex			
								(in)	(in)	(in)	(mm)	(mm)	(mm)
900	Socket/Female	1/4	1/8	1/8-27	NPTF	Brass	1	1.97	1.00	0.69	50.04	25.40	17.53
1100	Socket/Female	1/4	1/4	1/4-18	NPTF	Brass	1	2.16	1.00	0.69	54.86	25.40	17.53
1300	Socket/Female	1/4	3/8	3/8-18	NPTF	Brass	1	2.12	1.00	0.69	53.85	25.40	17.53
LL1100	Socket/Female	1/4	1/4	1/4-18	NPTF	Stainless	1	2.16	1.00	0.69	54.86	25.40	17.53

Part Number	Coupling Type	Body Size	Port Size	Thread	Type	Material	Fig.	Dimensions			C	D	Hex
								C	D	Hex			
								(in)	(in)	(in)	(mm)	(mm)	(mm)
10	Plug/Male	1/4	1/4	1/4-18	NPTF	Steel	2	1.75	0.62	0.56	44.45	15.75	14.22
10C§	Plug/Male	1/4	1/4	1/4-18	NPTF	Steel	2	1.75	0.65	0.56	44.45	16.51	14.22
10G†	Plug/Male	1/4	1/4	1/4-18	NPTF	Steel	2	1.75	0.65	0.56	44.45	16.51	14.22
12E	Plug/Male	1/4	1/8	1/8-27	NPTF	Steel	2	1.59	0.58	0.50	40.38	14.73	12.7
12G†	Plug/Male	1/4	1/8	1/8-27	NPTF	Steel	2	2.38	0.77	0.69	60.45	19.55	17.52
14	Plug/Male	1/4	3/8	3/8-18	NPTF	Steel	2	1.75	0.79	0.69	44.45	20.06	17.52
14G†	Plug/Male	1/4	3/8	3/8-18	NPTF	Steel	2	2.53	0.77	0.69	64.26	19.55	17.52
B10	Plug/Male	1/4	1/4	1/4-18	NPTF	Brass	2	1.75	0.62	0.56	44.45	16.25	14.22
LL10	Plug/Male	1/4	1/4	1/4-18	NPTF	Stainless	2	1.75	0.62	0.56	44.45	16.51	14.22
10NK*	Plug/Male	1/4	1/4	1/4-18	NPTF	Steel	2	1.75	0.62	0.56	44.45	15.75	14.22

§ With Ball Check †With Bleeder Ball Check—Reduces Hose Whip *Nickel plated

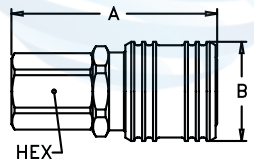

Figure 3

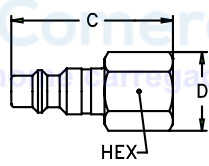

Figure 4

Female NPTF Connections

Part Number	Coupling Type	Body Size	Port Size	Thread	Type	Material	Fig.	Dimensions			A	B	Hex
								A	B	Hex			
								(in)	(in)	(in)	(mm)	(mm)	(mm)
800E	Socket/Female	1/4	1/8	1/8-27	NPTF	Brass	3	1.86	1.00	0.69	47.24	25.40	17.53
1000E	Socket/Female	1/4	1/4	1/4-18	NPTF	Brass	3	2.08	1.00	0.69	52.83	25.40	17.53
1200	Socket/Female	1/4	3/8	3/8-18	NPTF	Brass	3	2.16	1.00	0.75	54.86	25.40	19.05
LL1000	Socket/Female	1/4	1/4	1/4-18	NPTF	Stainless	3	2.08	1.00	0.69	52.83	25.40	17.53

Part Number	Coupling Type	Body Size	Port Size	Thread	Type	Material	Fig.	Dimensions			C	D	Hex
								C	D	Hex			
								(in)	(in)	(in)	(mm)	(mm)	(mm)
11	Plug/Male	1/4	1/4	1/4-18	NPTF	Steel	4	1.63	0.79	0.69	41.40	20.07	17.53
11G†	Plug/Male	1/4	1/4	1/4-18	NPTF	Steel	4	2.44	0.77	0.69	61.98	19.56	17.53
13	Plug/Male	1/4	1/8	1/8-27	NPTF	Steel	4	1.47	0.65	0.56	37.34	16.51	14.22
15E	Plug/Male	1/4	3/8	3/8-18	NPTF	Steel	4	1.69	0.94	0.81	42.93	23.88	20.57
11B	Plug/Male	1/4	1/4	1/4-18	NPTF	Brass	4	1.63	0.78	0.69	41.40	19.81	17.53
LL11	Plug/Male	1/4	1/4	1/4-18	NPTF	Stainless	4	1.63	0.79	0.69	41.40	20.07	17.53
11NK*	Plug/Male	1/4	1/4	1/4-18	NPTF	Steel	4	1.63	0.79	0.69	41.40	20.07	17.53

†With Bleeder Ball Check—Reduces Hose Whip *Nickel plated

1000 Series

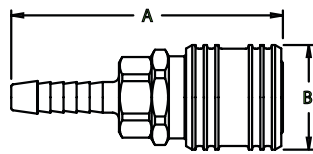

Figure 5

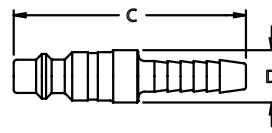

Figure 6

Hose Stem End Connections

Part Number	Coupling Type	Body Size	Hose I.D.	Material	Fig.	Dimensions		A	B
						A	B		
						(in)	(in)	(mm)	(mm)
1600E	Socket/Female	1/4	1/4	Brass	5	2.60	1.00	66.04	25.40
1600P‡	Socket/Female	1/4	1/4	Brass	5, 5A	2.37	1.00	60.20	25.40
1700E	Socket/Female	1/4	3/8	Brass	5	2.60	1.00	66.04	25.40
1700P‡	Socket/Female	1/4	3/8	Brass	5, 5A	2.44	1.00	61.98	25.40
1800	Socket/Female	1/4	5/16	Brass	5	2.60	1.00	66.04	25.40

Part Number	Coupling Type	Body Size	Hose I.D.	Material	Fig.	Dimensions		C	D
						C	D		
						(in)	(in)	(mm)	(mm)
16	Plug/Male	1/4	1/4	Steel	6	2.22	0.50	56.39	12.70
16G†	Plug/Male	1/4	1/4	Steel	6	2.97	0.77	75.44	19.56
16P‡	Plug/Male	1/4	1/4	Steel	6, 6A	2.00	0.58	50.80	14.73
17	Plug/Male	1/4	3/8	Steel	6	2.22	0.5	56.39	12.70
17G‡	Plug/Male	1/4	3/8	Steel	6	2.96	0.77	75.18	19.56
17P‡	Plug/Male	1/4	3/8	Steel	6, 6A	2.06	0.5	52.32	12.70
18E	Plug/Male	1/4	5/16	Steel	6	2.22	0.50	56.39	12.70
B17	Plug/Male	1/4	3/8	Brass	6	2.22	0.5	56.39	12.70
16NK*	Plug/Male	1/4	1/4	Steel	6	2.22	0.50	56.39	12.70
17NK*	Plug/Male	1/4	3/8	Steel	6	2.22	0.5	56.39	12.70

†With Bleeder Ball Check—Reduces Hose Whip ‡ For use with push-on style hose *Nickel plated

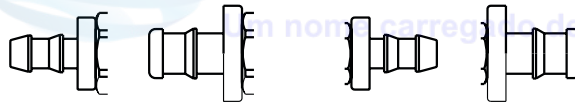

1600P 1700P
Figure 5A

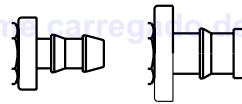

16P 17P
Figure 6A

FLUID TRANSFER
AND HYDRAULIC

PNEUMATIC

SPECIAL APPLICATIONS

DIAGNOSTIC

AGRICULTURE

REFRIGERANT

1000 Series

FLUID TRANSFER
AND HYDRAULIC

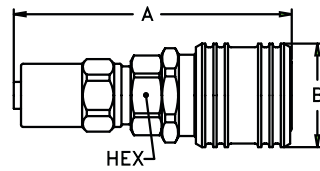

Figure 7

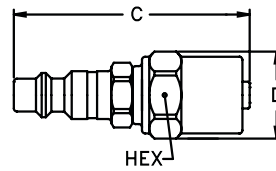

Figure 8

Hose Clamp End Connections

Part Number	Coupling Type	Body Size	Hose I.D.	Hose O.D.	Material	Fig.	Dimensions			A	B	Hex
							A	B	Hex			
							(in)	(in)	(in)	(mm)	(mm)	(mm)
1SB1	Socket/Female	1/4	1/4	15/32	Brass	7	2.69	1.00	0.69	68.33	25.40	17.53
1SB3	Socket/Female	1/4	1/4	1/2	Brass	7	2.69	1.00	0.69	68.33	25.40	17.53
1SB5E	Socket/Female	1/4	1/4	9/16	Brass	7	2.69	1.00	0.69	68.33	25.40	17.53
1SB7	Socket/Female	1/4	1/4	5/8	Brass	7	2.69	1.00	0.69	68.33	25.40	17.53
1SC5	Socket/Female	1/4	5/16	9/16	Brass	7	2.75	1.00	0.69	69.85	25.40	17.53
1SC7	Socket/Female	1/4	5/16	5/8	Brass	7	2.75	1.00	0.69	69.85	25.40	17.53
1SC9	Socket/Female	1/4	5/16	11/16	Brass	7	2.75	1.00	0.69	69.85	25.40	17.53
1SD5	Socket/Female	1/4	3/8	9/16	Brass	7	2.81	1.00	0.69	71.37	25.40	17.53
1SD7	Socket/Female	1/4	3/8	5/8	Brass	7	2.81	1.00	0.69	71.37	25.40	17.53
1SD9	Socket/Female	1/4	3/8	11/16	Brass	7	2.81	1.00	0.69	71.37	25.40	17.53
1SD11	Socket/Female	1/4	3/8	3/4	Brass	7	2.81	1.00	0.69	71.37	25.40	17.53

Part Number	Coupling Type	Body Size	Hose I.D.	Hose O.D.	Material	Fig.	Dimensions			C	D	Hex
							C	D	Hex			
							(in)	(in)	(in)	(mm)	(mm)	(mm)
3PB1	Plug/Male	1/4	1/4	15/32	Steel	8	2.31	0.70	0.63	58.67	17.78	16.00
3PB3	Plug/Male	1/4	1/4	1/2	Steel	8	2.31	0.70	0.63	58.67	17.78	16.00
3PB5	Plug/Male	1/4	1/4	9/16	Steel	8	2.31	0.77	0.69	58.67	19.56	17.53
3PB7	Plug/Male	1/4	1/4	5/8	Steel	8	2.31	0.84	0.75	58.67	21.34	19.05
3PB9	Plug/Male	1/4	1/4	11/16	Steel	8	2.31	0.94	0.81	58.67	23.88	20.57
3PB11	Plug/Male	1/4	1/4	3/4	Steel	8	2.31	0.98	0.88	58.67	24.89	22.35
3PC5	Plug/Male	1/4	5/16	9/16	Steel	8	2.38	0.77	0.69	60.45	19.56	17.53
3PC7	Plug/Male	1/4	5/16	5/8	Steel	8	2.38	0.84	0.75	60.45	21.34	19.05
3PC9	Plug/Male	1/4	5/16	11/16	Steel	8	2.38	0.91	0.81	60.45	23.11	20.57
3PD5	Plug/Male	1/4	3/8	9/16	Steel	8	2.44	0.77	0.69	61.98	19.56	17.53
3PD7	Plug/Male	1/4	3/8	5/8	Steel	8	2.44	0.84	0.75	61.98	21.34	19.05
3PD9	Plug/Male	1/4	3/8	11/16	Steel	8	2.44	0.91	0.81	61.98	23.11	20.57
3PD11	Plug/Male	1/4	3/8	3/4	Steel	8	2.44	1.01	0.88	61.98	25.65	22.35

PNEUMATIC

SPECIAL APPLICATIONS

DIAGNOSTIC

AGRICULTURE

REFRIGERANT

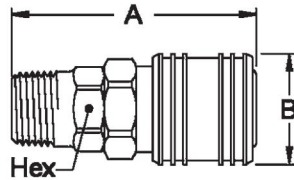

Figure 1

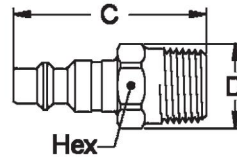

Figure 2

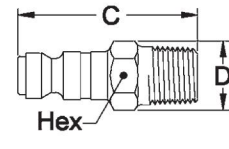

Figure 2A

Male NPTF Connections

Part Number	Coupling Type	Body Size	Port Size	Thread	Type	Material	Fig.	Dimensions			A	B	Hex
								A	B	Hex			
410	Socket/Female	3/8	1/4	1/4-18	NPTF	Brass	1	2.35	1.13	0.88	59.69	28.70	22.35
430	Socket/Female	3/8	3/8	3/8-18	NPTF	Brass	1	2.35	1.13	0.88	59.69	28.70	22.35
450	Socket/Female	3/8	1/2	1/2-14	NPTF	Brass	1	2.54	1.13	0.88	64.52	28.70	22.35
Part Number	Coupling Type	Body Size	Port Size	Thread	Type	Material	Fig.	Dimensions			C	D	Hex
								C	D	Hex			
38	Plug/Male	3/8	1/8	1/8-27	NPTF	Steel	2	1.72	0.72	0.63	43.69	18.29	16.00
40	Plug/Male	3/8	1/4	1/4-18	NPTF	Steel	2	1.88	0.72	0.63	47.75	18.29	16.00
40NK*	Plug/Male	3/8	1/4	1/4-18	NPTF	Steel	2	1.88	0.72	0.63	47.75	18.29	16.00
40G†	Plug/Male	3/8	1/4	1/4-18	NPTF	Steel	2	2.65	0.77	0.69	67.31	19.56	17.53
42	Plug/Male	3/8	3/8	3/8-18	NPTF	Steel	2	1.88	0.79	0.69	47.75	20.07	17.53
42G†	Plug/Male	3/8	3/8	3/8-18	NPTF	Steel	2	2.65	0.77	0.69	67.31	19.56	17.53
44	Plug/Male	3/8	1/2	1/2-14	NPTF	Steel	2	2.09	1.01	0.88	53.09	25.65	22.35
B40	Plug/Male	3/8	1/4	1/4-18	NPTF	Brass	2	1.88	0.70	0.63	47.75	17.78	16.00
B42	Plug/Male	3/8	3/8	3/8-18	NPTF	Brass	2	1.88	0.77	0.69	47.75	19.56	17.53
31AP25M	Plug/Male	3/8	1/4	1/4-18	NPTF	Steel	2A	1.85	0.72	0.63	46.99	18.29	16.00
31AP37M	Plug/Male	3/8	3/8	3/8-18	NPTF	Steel	2A	1.85	0.79	0.69	46.99	20.07	17.53

†With Bleeder Ball Check—Reduces Hose Whip *Nickel plated

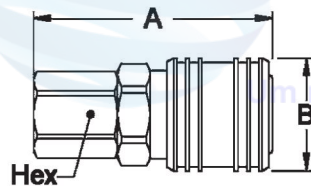

Figure 3

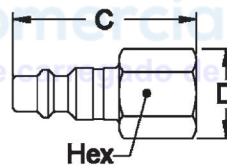

Figure 4

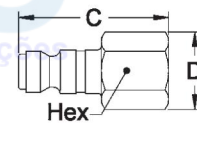

Figure 4A

Female NPTF Connections

Part Number	Coupling Type	Body Size	Port Size	Thread	Type	Material	Fig.	Dimensions			A	B	Hex
								A	B	Hex			
400	Socket/Female	3/8	1/4	1/4-18	NPTF	Brass	3	2.10	1.13	0.88	53.34	28.70	22.35
420	Socket/Female	3/8	3/8	3/8-18	NPTF	Brass	3	2.35	1.13	0.88	59.69	28.70	22.35
440	Socket/Female	3/8	1/2	1/2-14	NPTF	Brass	3	2.62	1.13	1.00	66.55	28.70	25.40
Part Number	Coupling Type	Body Size	Port Size	Thread	Type	Material	Fig.	Dimensions			C	D	Hex
								C	D	Hex			
41	Plug/Male	3/8	1/4	1/4-18	NPTF	Steel	4	1.63	0.79	0.69	41.40	20.07	17.53
41NK*	Plug/Male	3/8	1/4	1/4-18	NPTF	Steel	4	1.63	0.79	0.69	41.40	20.07	17.53
41G†	Plug/Male	3/8	1/4	1/4-18	NPTF	Steel	4	2.56	0.77	0.69	65.02	19.56	17.53
43	Plug/Male	3/8	3/8	3/8-18	NPTF	Steel	4	1.81	0.94	0.81	45.97	23.88	20.57
43G†	Plug/Male	3/8	3/8	3/8-18	NPTF	Steel	4	2.62	0.84	0.75	66.55	21.34	19.05
45E	Plug/Male	3/8	1/2	1/2-14	NPTF	Steel	4	2.06	1.15	1.00	52.32	29.21	25.40
B43	Plug/Male	3/8	3/8	3/8-18	NPTF	Brass	4	1.81	0.91	0.81	45.97	23.11	20.57
31AP25F	Plug/Male	3/8	1/4	1/4-18	NPTF	Steel	4A	1.60	0.79	0.69	40.64	20.07	17.53
31AP37F	Plug/Male	3/8	3/8	3/8-18	NPTF	Steel	4A	1.78	0.94	0.81	45.21	23.88	20.57

†With Bleeder Ball Check—Reduces Hose Whip *Nickel plated

400 Series

FLUID TRANSFER
AND HYDRAULIC

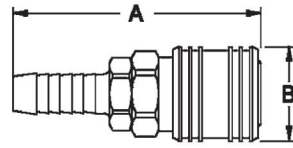

Figure 5

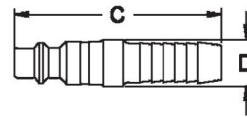

Figure 6

Hose Stem End Connections

Part Number	Coupling Type	Body Size	Hose I.D.	Material	Fig.	Dimensions		A	B
						A	B		
4004E	Socket/Female	3/8	1/4	Brass	5	2.82	1.13	71.63	28.70
4050E	Socket/Female	3/8	5/16	Brass	5	2.82	1.13	71.63	28.70
4006E	Socket/Female	3/8	3/8	Brass	5	2.82	1.13	71.63	28.70
4008E	Socket/Female	3/8	1/2	Brass	5	2.82	1.13	71.63	28.70

Part Number	Coupling Type	Body Size	Hose I.D.	Material	Fig.	Dimensions		C	D
						C	D		
404	Plug/Male	3/8	1/4	Steel	6	2.34	0.72	59.44	18.29
406	Plug/Male	3/8	3/8	Steel	6	2.34	0.63	59.44	16.00
408	Plug/Male	3/8	1/2	Steel	6	2.34	0.81	59.44	20.57
B406E	Plug/Male	3/8	3/8	Brass	6	2.34	0.63	59.44	16.00

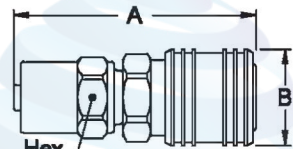

Figure 7

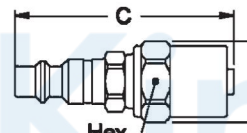

Figure 8

Hose Clamp End Connections

Part Number	Coupling Type	Body Size	Hose I.D.	Hose O.D.	Material	Fig.	Dimensions			A	B	Hex
							A	B	Hex			
40SD7	Socket/Female	3/8	3/8	5/8	Brass	7	3.04	1.13	0.75	77.22	28.70	19.05
40SD9	Socket/Female	3/8	3/8	11/16	Brass	7	3.04	1.13	0.81	77.22	28.70	20.57
40SD11	Socket/Female	3/8	3/8	3/4	Brass	7	3.04	1.13	0.88	77.22	28.70	22.35
40SP13	Socket/Female	3/8	1/2	13/16	Brass	7	3.67	1.13	0.94	93.22	28.70	23.88
40SP15	Socket/Female	3/8	1/2	7/8	Brass	7	3.67	1.13	1.00	93.22	28.70	25.40
40SP17	Socket/Female	3/8	1/2	5/16	Brass	7	3.67	1.13	1.00	93.22	28.70	25.40
40SP19	Socket/Female	3/8	1/2	1	Brass	7	3.67	1.13	1.13	93.22	28.70	28.70

Part Number	Coupling Type	Body Size	Hose I.D.	Hose O.D.	Material	Fig.	Dimensions			C	D	Hex
							C	D	Hex			
4PB3	Plug/Male	3/8	1/4	1/2	Steel	8	2.44	0.70	0.63	61.98	17.78	16.00
4PB5	Plug/Male	3/8	1/4	9/16	Steel	8	2.44	0.77	0.69	61.98	19.56	17.53
4PB7	Plug/Male	3/8	1/4	5/8	Steel	8	2.44	0.84	0.75	61.98	21.34	19.05
4PD7	Plug/Male	3/8	3/8	5/8	Steel	8	2.56	0.84	0.75	65.02	21.34	19.05
4PD9	Plug/Male	3/8	3/8	11/16	Steel	8	2.56	0.91	0.81	65.02	23.11	20.57
4PD11	Plug/Male	3/8	3/8	3/4	Steel	8	2.56	0.98	0.88	65.02	24.89	22.35
4PD15	Plug/Male	3/8	3/8	7/8	Steel	8	2.56	1.12	1.00	65.02	28.45	25.40
4PP13	Plug/Male	3/8	1/2	13/16	Steel	8	3.25	1.05	0.94	82.55	26.67	23.88
4PP15	Plug/Male	3/8	1/2	7/8	Steel	8	3.25	1.12	1.00	82.55	28.45	25.40
4PP19	Plug/Male	3/8	1/2	1	Steel	8	3.25	1.26	1.13	82.55	32.00	28.58

Dust Plugs

Series	Dust Plug Number
1000	PSDC1HK
400	PSDC2HK



Vinyl Dust Plug

PNEUMATIC

SPECIAL APPLICATIONS

DIAGNOSTIC

AGRICULTURE

REFRIGERANT

500 Series

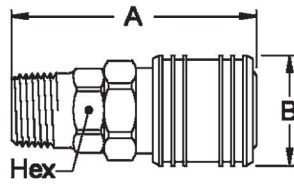

Figure 1

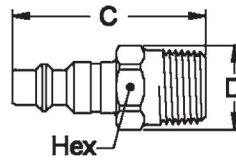

Figure 2

Male End Connections

Part Number	Coupling Type	Body Size	Port Size	Thread	Type	Material	Fig.	Dimensions			A	B	Hex
								A	B	Hex			
								(in)	(in)	(in)	(mm)	(mm)	(mm)
501	Socket/Female	1/2	1/4	1/4-18	NPTF	Brass	1	2.77	1.19	1.00	70.36	30.23	25.40
510	Socket/Female	1/2	3/8	3/8-18	NPTF	Brass	1	2.78	1.19	1.00	70.61	30.23	25.40
530E	Socket/Female	1/2	1/2	1/2-14	NPTF	Brass	1	2.97	1.19	1.00	75.44	30.23	25.40
550	Socket/Female	1/2	3/4	3/4-14	NPTF	Brass	1	2.97	1.19	1.06	75.44	30.23	26.92
530143	Socket/Female	1/2	1/2	1/2-14	NPTF	Brass	1	2.97	1.19	1.00	75.44	30.23	25.40
550NV	Socket/Female	1/2	3/4	3/4-14	NPTF	Brass	1	2.97	1.19	1.06	75.44	30.23	26.92
Part Number	Coupling Type	Body Size	Port Size	Thread	Type	Material	Fig.	Dimensions			C	D	Hex
								C	D	Hex			
								(in)	(in)	(in)	(mm)	(mm)	(mm)
50E	Plug/Male	1/2	1/4	1/4-18	NPTF	Steel	2	2.25	0.79	0.69	57.15	20.07	17.53
50G†	Plug/Male	1/2	1/4	1/4-18	NPTF	Steel	2	2.90	0.98	0.88	73.66	24.89	22.35
52	Plug/Male	1/2	3/8	3/8-18	NPTF	Steel	2	2.25	0.87	0.75	57.15	22.10	19.05
52G†	Plug/Male	1/2	3/8	3/8-18	NPTF	Steel	2	2.90	0.98	0.88	73.66	24.89	22.35
54E	Plug/Male	1/2	1/2	1/2-14	NPTF	Steel	2	2.44	1.01	0.88	61.98	25.65	22.35
54G†	Plug/Male	1/2	1/2	1/2-14	NPTF	Steel	2	3.09	0.98	0.88	78.49	24.89	22.35
56	Plug/Male	1/2	3/4	3/4-14	NPTF	Steel	2	2.50	1.23	1.06	63.50	31.24	26.92
56G†	Plug/Male	1/2	3/4	3/4-14	NPTF	Steel	2	3.14	1.19	1.06	79.76	30.23	26.92
B52	Plug/Male	1/2	3/8	3/8-18	NPTF	Brass	2	2.25	0.87	0.75	57.15	22.10	19.05
B54	Plug/Male	1/2	1/2	1/2-14	NPTF	Brass	2	2.44	1.01	0.88	61.98	25.65	22.35

†With Bleeder Ball Check—Reduces Hose Whip

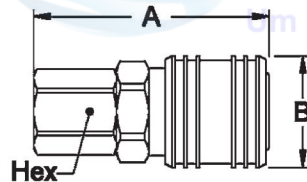

Figure 3

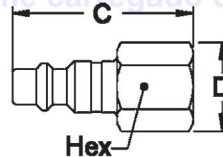

Figure 4

Female End Connections

Part Number	Coupling Type	Body Size	Port Size	Thread	Type	Material	Fig.	Dimensions			A	B	Hex
								A	B	Hex			
								(in)	(in)	(in)	(mm)	(mm)	(mm)
500A	Socket/Female	1/2	1/4	1/4-18	NPTF	Brass	3	2.72	1.19	1.00	69.1	30.2	25.4
500	Socket/Female	1/2	3/8	3/8-18	NPTF	Brass	3	2.78	1.19	1.00	70.6	30.2	25.4
520	Socket/Female	1/2	1/2	1/2-14	NPTF	Brass	3	3.06	1.19	1.00	77.7	30.2	25.4
540	Socket/Female	1/2	3/4	3/4-14	NPTF	Brass	3	3.09	1.19	1.19	78.5	30.2	30.2
Part Number	Coupling Type	Body Size	Port Size	Thread	Type	Material	Fig.	Dimensions			C	D	Hex
								C	D	Hex			
								(in)	(in)	(in)	(mm)	(mm)	(mm)
53A	Plug/Male	1/2	1/4	1/4-18	NPTF	Steel	4	1.92	0.79	0.69	48.8	20.1	17.5
53	Plug/Male	1/2	3/8	3/8-18	NPTF	Steel	4	2.06	0.94	0.81	52.3	23.9	20.6
53G†	Plug/Male	1/2	3/8	3/8-18	NPTF	Steel	4	2.90	0.98	0.88	73.7	24.9	22.4
55	Plug/Male	1/2	1/2	1/2-14	NPTF	Steel	4	2.34	1.15	1.00	59.4	29.2	25.4
55G†	Plug/Male	1/2	1/2	1/2-14	NPTF	Steel	4	3.17	1.15	1.00	80.5	29.2	25.4
57	Plug/Male	1/2	3/4	3/4-14	NPTF	Steel	4	2.44	1.37	1.19	62.0	34.8	30.2

†With Bleeder Ball Check—Reduces Hose Whip

FLUID TRANSFER AND HYDRAULIC

PNEUMATIC

SPECIAL APPLICATIONS

DIAGNOSTIC

AGRICULTURE

REFRIGERANT

500 Series

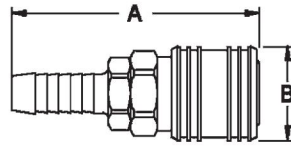

Figure 5

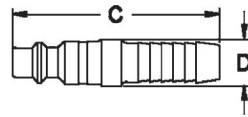

Figure 6

Hose Stem End Connections

Part Number	Coupling Type	Body Size	Hose I.D.	Material	Fig.	Dimensions		A	B
						(in)	(in)		
570	Socket/Female	1/2	3/8	Brass	5	3.32	1.19	84.3	30.2
580	Socket/Female	1/2	1/2	Brass	5	3.24	1.19	82.3	30.2
590	Socket/Female	1/2	3/4	Brass	5	4.09	1.19	103.9	30.2

Part Number	Coupling Type	Body Size	Hose I.D.	Material	Fig.	Dimensions		C	D
						(in)	(in)		
585	Plug/Male	1/2	5/16	Steel	6	2.66	0.69	67.6	17.5
585G†	Plug/Male	1/2	5/16	Brass	6	3.37	0.98	85.6	24.9
59	Plug/Male	1/2	3/8	Steel	6	2.66	0.69	67.6	17.5
59G†	Plug/Male	1/2	3/8	Brass	6	3.37	0.98	85.6	24.9
60	Plug/Male	1/2	1/2	Steel	6	2.66	0.75	67.6	19.1
60G†	Plug/Male	1/2	1/2	Brass	6	3.37	0.98	85.6	24.9
61E	Plug/Male	1/2	3/4	Steel	6	3.50	1.00	88.9	25.4
61G†	Plug/Male	1/2	3/4	Brass	6	4.22	1.00	107.2	25.4

†With Bleeder Ball Check—Reduces Hose Whip

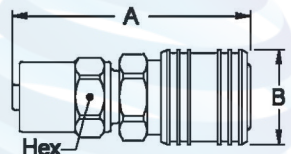

Figure 7

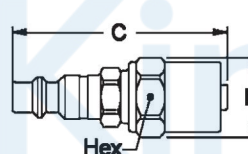

Figure 8

Hose Clamp End Connections

Part Number	Coupling Type	Body Size	Hose I.D.	Hose O.D.	Material	Fig.	Dimensions			A	B	Hex
							(in)	(in)	(in)			
50SP13	Socket/Female	1/2	1/2	13/16	Brass	7	4.09	1.19	0.94	103.9	30.2	23.9
50SP15	Socket/Female	1/2	1/2	7/8	Brass	7	4.09	1.19	1.00	103.9	30.2	25.4
5019E	Socket/Female	1/2	1/2	1	Brass	7	4.09	1.26	1.13	103.9	32.0	28.7
50SR23	Socket/Female	1/2	3/4	1 1/8	Brass	7	4.22	1.19	1.25	107.2	30.2	31.8
50SR25	Socket/Female	1/2	3/4	1 3/16	Brass	7	4.22	1.19	1.31	107.2	30.2	33.3
50SR27	Socket/Female	1/2	3/4	1 1/4	Brass	7	4.22	1.19	1.38	107.2	30.2	35.1

Part Number	Coupling Type	Body Size	Hose I.D.	Hose O.D.	Material	Fig.	Dimensions			C	D	Hex
							(in)	(in)	(in)			
5PB3	Plug/Male	1/2	1/4	1/2	Steel	8	2.81	0.70	0.63	71.4	17.8	16.0
5PB5	Plug/Male	1/2	1/4	9/16	Steel	8	2.81	0.77	0.69	71.4	19.6	17.5
5PB7	Plug/Male	1/2	1/4	5/8	Steel	8	2.81	0.84	0.75	71.4	21.3	19.1
5PD5	Plug/Male	1/2	3/8	9/16	Steel	8	2.94	0.77	0.69	74.7	19.6	17.5
5PD7	Plug/Male	1/2	3/8	5/8	Steel	8	2.94	0.84	0.75	74.7	21.3	19.1
5PD9	Plug/Male	1/2	3/8	11/16	Steel	8	2.94	0.91	0.81	74.7	23.1	20.6
5PD11	Plug/Male	1/2	3/8	3/4	Steel	8	2.94	0.98	0.88	74.7	24.9	22.4
5PD13	Plug/Male	1/2	3/8	13/16	Steel	8	2.94	1.05	0.94	74.7	26.7	23.9
5PP13	Plug/Male	1/2	1/2	13/16	Steel	8	3.62	1.05	0.94	91.9	26.7	23.9
5PP15	Plug/Male	1/2	1/2	7/8	Steel	8	3.62	1.12	1.00	91.9	28.4	25.4
5PR23	Plug/Male	1/2	3/4	1 1/8	Steel	8	3.75	1.40	1.25	95.3	35.6	31.8
5PR25	Plug/Male	1/2	3/4	1 3/16	Steel	8	3.75	1.47	1.31	95.3	37.3	33.3
5PR27	Plug/Male	1/2	3/4	1 1/4	Steel	8	3.75	1.54	1.38	95.3	39.1	35.1

3000/4000/5000/6000 Series



Eaton's 3000/4000/5000/6000 Series Industrial Interchange pin lock pneumatic quick disconnect couplings are designed for compressed air, gases, and liquids. This series sets the industry standard for pin lock style pneumatic couplings.

FLUID TRANSFER
AND HYDRAULIC

PNEUMATIC

SPECIAL APPLICATIONS

DIAGNOSTIC

AGRICULTURE

REFRIGERANT

Product Features

- Easy, automatic, push-to-connect design provides instantaneous connection and disconnection of lines, plus automatic shut-off of socket/female end of line
- All sizes accept US industrial Interchange; 1/4" & 1/2" also accept ISO 6150 Series B and A-A-59439 plugs/males
- Optional sleeve lock option prevents accidental disconnection
- Standard body material: Brass
- Standard seal material: Buna-N
- Optional seal and valve materials: Silicone-138, FKM-143, EPDM-192

Physical Characteristics

Series	Body Size	Max. Operating Pressure		Min. Burst Pressure		Rated Flow	
	(in)	(bar)	(psi)	(bar)	(psi)	(lpm)	scfm
3000	1/4	138	2,000	552	8,000	680	24
4000	3/8	69	1,000	276	4,000	1,274	45
5000	1/2	35	500	140	2,000	2,040	72
6000	3/4	15	220	60	880	3,540	125

Applications & Markets

- Industrial Breathing Air
- General Pneumatics
- Maintenance & Repair
- Fluid Transfer

Interchangeability

All Sizes	1/4" & 1/2"
US Industrial Interchange	ISO 6150 Series B
	A-A-59439 (former MIL-C-4109)

Flow Data

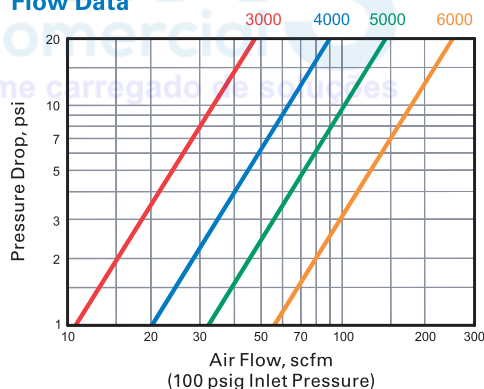

3000 Series

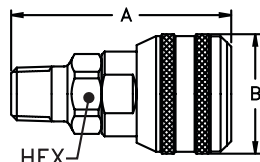

Figure 1

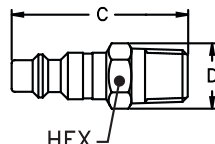

Figure 2

Male End Connections

Part Number	Coupling Type	Body Size	Port Size	Thread	Type	Material	Fig.	Dimensions			A	B	Hex
								A	B	Hex			
2900	Socket/Female	1/4	1/8	1/8-27	NPTF	Brass	1	2.00	1.19	0.69	50.80	30.23	17.53
3100E	Socket/Female	1/4	1/4	1/4-18	NPTF	Brass	1	2.19	1.19	0.69	55.63	30.23	17.53
3300E	Socket/Female	1/4	3/8	3/8-18	NPTF	Brass	1	2.15	1.19	0.69	54.61	30.23	17.53
300043*	Socket/Female	1/4	7/16	7/16-20	UNF	Brass	1	2.10	1.19	0.69	53.34	30.23	17.53

Part Number	Coupling Type	Body Size	Port Size	Thread	Type	Material	Fig.	Dimensions			C	D	Hex
								C	D	Hex			
10	Plug/Male	1/4	1/4	1/4-18	NPTF	Steel	2	1.75	0.62	0.56	44.45	15.85	14.22
10C§	Plug/Male	1/4	1/4	1/4-18	NPTF	Steel	2	1.75	0.65	0.56	44.45	16.51	14.22
10G†	Plug/Male	1/4	1/4	1/4-18	NPTF	Steel	2	1.75	0.65	0.56	44.45	16.51	14.22
12E	Plug/Male	1/4	1/8	1/8-27	NPTF	Steel	2	1.59	0.58	0.50	40.39	14.73	12.70
12G†	Plug/Male	1/4	1/8	1/8-27	NPTF	Steel	2	2.38	0.77	0.69	60.45	19.56	17.53
14	Plug/Male	1/4	3/8	3/8-18	NPTF	Steel	2	1.75	0.79	0.69	44.45	20.07	17.53
14G†	Plug/Male	1/4	3/8	3/8-18	NPTF	Steel	2	2.53	0.77	0.69	64.26	19.56	17.53
B10	Plug/Male	1/4	1/4	1/4-18	NPTF	Brass	2	1.75	0.62	0.56	44.45	15.75	14.22
LL10	Plug/Male	1/4	1/4	1/4-18	NPTF	Stainless	2	1.75	0.62	0.56	44.45	15.85	14.22
10NK**	Plug/Male	1/4	1/4	1/4-18	NPTF	Steel	2	1.75	0.62	0.56	44.45	15.75	14.22

*45° Male Flare § With Ball Check †With Bleeder Ball Check—Reduces Hose Whip **Nickel plated

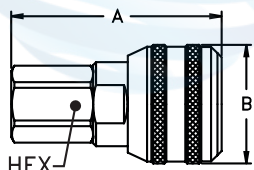

Figure 3

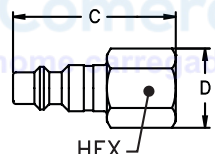

Figure 4

Female End Connections

Part Number	Coupling Type	Body Size	Port Size	Thread	Type	Material	Fig.	Dimensions			A	B	Hex
								A	B	Hex			
2800	Socket/Female	1/4	1/8	1/8-27	NPTF	Brass	3	1.89	1.19	0.69	48.01	30.23	17.53
3000	Socket/Female	1/4	1/4	1/4-18	NPTF	Brass	3	2.11	1.19	0.69	53.59	30.23	17.53
3200	Socket/Female	1/4	3/8	3/8-18	NPTF	Brass	3	2.19	1.19	0.75	55.63	30.23	19.05

Part Number	Coupling Type	Body Size	Port Size	Thread	Type	Material	Fig.	Dimensions			C	D	Hex
								C	D	Hex			
11	Plug/Male	1/4	1/4	1/4-18	NPTF	Steel	4	1.63	0.79	0.69	41.40	20.07	17.53
11G†	Plug/Male	1/4	1/4	1/4-18	NPTF	Steel	4	2.44	0.77	0.69	61.98	19.56	17.53
13	Plug/Male	1/4	1/8	1/8-27	NPTF	Steel	4	1.47	0.65	0.56	37.34	16.51	14.22
15E	Plug/Male	1/4	3/8	3/8-18	NPTF	Steel	4	1.69	0.94	0.81	42.93	23.88	20.57
11B	Plug/Male	1/4	1/4	1/4-18	NPTF	Brass	4	1.63	0.79	0.69	41.40	20.07	17.53
LL11	Plug/Male	1/4	1/4	1/4-18	NPTF	Stainless	4	1.63	0.79	0.69	41.40	20.07	17.53
11NK*	Plug/Male	1/4	1/4	1/4-18	NPTF	Steel	4	1.63	0.79	0.69	41.40	20.07	17.53

†With Bleeder Ball Check—Reduces Hose Whip *Nickel plated

3000 Series

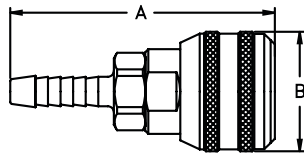

Figure 5

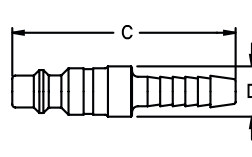

Figure 6

Hose Stem End Connections

Part Number	Coupling Type	Body Size	Hose I.D.	Material	Fig.	Dimensions		A	B
						A	B		
						(in)	(in)	(mm)	(mm)
3600	Socket/Female	1/4	1/4	Brass	5	2.63	1.19	66.80	30.23
3600P‡	Socket/Female	1/4	1/4	Brass	5, 5A	2.40	1.19	60.96	30.23
3700E	Socket/Female	1/4	3/8	Brass	5	2.63	1.19	66.80	30.23
3700P‡	Socket/Female	1/4	3/8	Brass	5, 5A	2.47	1.19	62.74	30.23
3800	Socket/Female	1/4	5/16	Brass	5	2.63	1.19	66.80	30.23
Part Number	Coupling Type	Body Size	Hose I.D.	Material	Fig.	Dimensions		C	D
						C	D		
						(in)	(in)	(mm)	(mm)
16	Plug/Male	1/4	1/4	Steel	6	2.22	0.50	56.39	12.70
16G†	Plug/Male	1/4	1/4	Steel	6	2.97	0.77	75.44	19.56
16P‡	Plug/Male	1/4	1/4	Steel	6, 6A	2.00	0.58	50.80	14.73
17	Plug/Male	1/4	3/8	Steel	6	2.22	0.50	56.39	12.70
17G†	Plug/Male	1/4	3/8	Steel	6	2.96	0.77	75.18	19.56
17P‡	Plug/Male	1/4	3/8	Steel	6, 6A	2.06	0.5	52.32	12.70
18E	Plug/Male	1/4	5/16	Steel	6	2.22	0.50	56.39	12.70
B17	Plug/Male	1/4	3/8	Brass	6	2.22	0.50	56.39	12.70
16NK*	Plug/Male	1/4	1/4	Steel	6	2.22	0.5	56.39	12.70
17NK*	Plug/Male	1/4	3/8	Steel	6	2.22	0.5	56.39	12.70

†With Bleeder Ball Checkv—Reduces Hose Whip ‡ For use with push-on style hose *Nickel plated

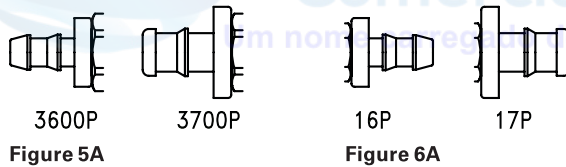

Figure 5A

Figure 6A

FLUID TRANSFER AND HYDRAULIC

PNEUMATIC

SPECIAL APPLICATIONS

DIAGNOSTIC

AGRICULTURE

REFRIGERANT

3000 Series

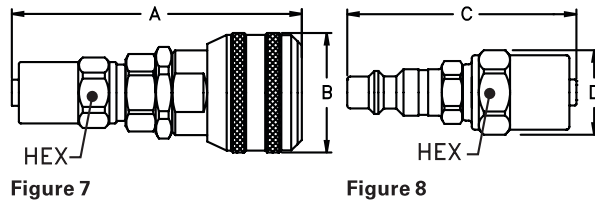

Figure 7

Figure 8

Hose Clamp End Connections

Part Number	Coupling Type	Body Size	Hose I.D.	Hose O.D.	Material	Fig.	Dimensions			Hex	A	B	Hex
							A	B	Hex				
							(in)	(in)	(in)	(mm)	(mm)	(mm)	
3SA0	Socket/Female	1/4	3/16	7/16	Brass	7	2.65	1.19	0.56	67.31	30.23	14.22	
3SB1	Socket/Female	1/4	1/4	15/32	Brass	7	2.72	1.19	0.63	69.09	30.23	16.00	
3SB3	Socket/Female	1/4	1/4	1/2	Brass	7	2.72	1.19	0.63	69.09	30.23	16.00	
3SB5	Socket/Female	1/4	1/4	9/16	Brass	7	2.72	1.19	0.69	69.09	30.23	17.53	
3SB7	Socket/Female	1/4	1/4	5/8	Brass	7	2.72	1.19	0.75	69.09	30.23	19.05	
3SB9	Socket/Female	1/4	1/4	11/16	Brass	7	2.72	1.19	0.81	69.09	30.23	20.57	
3SC5	Socket/Female	1/4	5/16	9/16	Brass	7	2.78	1.19	0.69	70.61	30.23	17.53	
3SC7	Socket/Female	1/4	5/16	5/8	Brass	7	2.78	1.19	0.75	70.61	30.23	19.05	
3SC9	Socket/Female	1/4	5/16	11/16	Brass	7	2.78	1.19	0.81	70.61	30.23	20.57	
3SD5	Socket/Female	1/4	3/8	9/16	Brass	7	2.84	1.19	0.69	72.14	30.23	17.53	
3SD7	Socket/Female	1/4	3/8	5/8	Brass	7	2.84	1.19	0.75	72.14	30.23	19.05	
3SD9	Socket/Female	1/4	3/8	11/16	Brass	7	2.84	1.19	0.81	72.14	30.23	20.57	
3SD11	Socket/Female	1/4	3/8	3/4	Brass	7	2.84	1.19	0.88	72.14	30.23	22.35	
Part Number	Coupling Type	Body Size	Hose I.D.	Hose O.D.	Material	Fig.	Dimensions			Hex	C	D	Hex
							C	D	Hex				
							(in)	(in)	(in)	(mm)	(mm)	(mm)	
3PB1	Plug/Male	1/4	1/4	15/32	Steel	8	2.31	0.70	0.63	58.67	17.78	16.00	
3PB3	Plug/Male	1/4	1/4	1/2	Steel	8	2.31	0.70	0.63	58.67	17.78	16.00	
3PB5	Plug/Male	1/4	1/4	9/16	Steel	8	2.31	0.77	0.69	58.67	19.56	17.53	
3PB7	Plug/Male	1/4	1/4	5/8	Steel	8	2.31	0.84	0.75	58.67	21.34	19.05	
3PB9	Plug/Male	1/4	1/4	11/16	Steel	8	2.31	0.91	0.81	58.67	23.11	20.57	
3PB11	Plug/Male	1/4	1/4	3/4	Steel	8	2.31	0.98	0.88	58.67	24.89	22.35	
3PC5	Plug/Male	1/4	5/16	9/16	Steel	8	2.38	0.77	0.69	60.45	19.56	17.53	
3PC7	Plug/Male	1/4	5/16	5/8	Steel	8	2.38	0.84	0.75	60.45	21.34	19.05	
3PC9	Plug/Male	1/4	5/16	11/16	Steel	8	2.38	0.91	0.81	60.45	23.11	20.57	
3PD5	Plug/Male	1/4	3/8	9/16	Steel	8	2.44	0.77	0.69	61.98	19.56	17.53	
3PD7	Plug/Male	1/4	3/8	5/8	Steel	8	2.44	0.84	0.75	61.98	21.34	19.05	
3PD9	Plug/Male	1/4	3/8	11/16	Steel	8	2.44	0.91	0.81	61.98	23.11	20.57	
3PD11	Plug/Male	1/4	3/8	3/4	Steel	8	2.44	0.98	0.88	61.98	24.89	22.35	

FLUID TRANSFER AND HYDRAULIC

PNEUMATIC

SPECIAL APPLICATIONS

DIAGNOSTIC

AGRICULTURE

REFRIGERANT

4000 Series

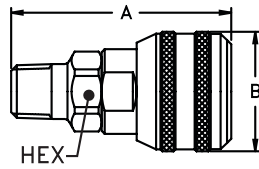

Figure 1

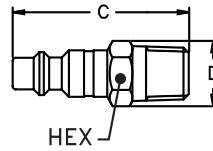

Figure 2

Male End Connections

Part Number	Coupling Type	Body Size	Port Size	Thread	Type	Material	Fig.	Dimensions			A	B	Hex
								A	B	Hex			
4100A	Socket/Female	3/8	1/8	1/8-27	NPTF	Brass	1	2.20	1.38	0.88	55.88	35.05	22.35
4100	Socket/Female	3/8	1/4	1/4-18	NPTF	Brass	1	2.35	1.38	0.88	59.69	35.05	22.35
4300	Socket/Female	3/8	3/8	3/8-18	NPTF	Brass	1	2.35	1.38	0.88	59.69	35.05	22.35
4500E	Socket/Female	3/8	1/2	1/2-14	NPTF	Brass	1	2.54	1.38	0.88	64.52	35.05	22.35
Part Number	Coupling Type	Body Size	Port Size	Thread	Type	Material	Fig.	Dimensions			C	D	Hex
								C	D	Hex			
38	Plug/Male	3/8	1/8	1/8-27	NPTF	Steel	2	1.72	0.72	0.63	43.69	18.29	16.00
40	Plug/Male	3/8	1/4	1/4-18	NPTF	Steel	2	1.88	0.72	0.63	47.75	18.29	16.00
40G†	Plug/Male	3/8	1/4	1/4-18	NPTF	Steel	2	2.65	0.77	0.69	67.31	19.56	17.53
42	Plug/Male	3/8	3/8	3/8-18	NPTF	Steel	2	1.88	0.79	0.69	47.75	20.07	17.53
42G†	Plug/Male	3/8	3/8	3/8-18	NPTF	Steel	2	2.65	0.77	0.69	67.31	19.56	17.53
44	Plug/Male	3/8	1/2	1/2-14	NPTF	Steel	2	2.09	1.01	0.88	53.09	25.65	22.35
B40	Plug/Male	3/8	1/4	1/4-18	NPTF	Brass	2	1.88	0.70	0.63	47.75	17.78	16.00
B42	Plug/Male	3/8	3/8	3/8-18	NPTF	Brass	2	1.88	0.77	0.69	47.75	19.56	17.53
40NK*	Plug/Male	3/8	1/4	1/4-18	NPTF	Steel	2	1.88	0.72	0.63	47.75	18.29	16.00

†With Bleeder Ball Check—Reduces Hose Whip *Nickel plated

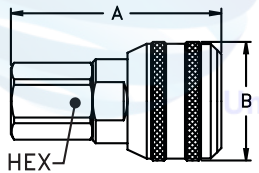

Figure 3

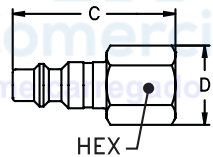

Figure 4

Female End Connections

Part Number	Coupling Type	Body Size	Port Size	Thread	Type	Material	Fig.	Dimensions			A	B	Hex
								A	B	Hex			
4000A	Socket/Female	3/8	1/8	1/8-27	NPTF	Brass	3	2.10	1.38	0.88	53.34	35.05	22.35
4000	Socket/Female	3/8	1/4	1/4-18	NPTF	Brass	3	2.10	1.38	0.88	53.34	35.05	22.35
4200	Socket/Female	3/8	3/8	3/8-18	NPTF	Brass	3	2.35	1.38	0.88	59.69	35.05	22.35
4400	Socket/Female	3/8	1/2	1/2-14	NPTF	Brass	3	2.62	1.38	1	66.55	35.05	25.40
Part Number	Coupling Type	Body Size	Port Size	Thread	Type	Material	Fig.	Dimensions			C	D	Hex
								C	D	Hex			
41	Plug/Male	3/8	1/4	1/4-18	NPTF	Steel	4	1.63	0.79	0.69	41.40	20.07	17.53
41G†	Plug/Male	3/8	1/4	1/4-18	NPTF	Steel	4	2.56	0.77	0.69	65.02	19.56	17.53
43	Plug/Male	3/8	3/8	3/8-18	NPTF	Steel	4	1.81	0.94	0.81	45.97	23.88	20.57
43G†	Plug/Male	3/8	3/8	3/8-18	NPTF	Steel	4	2.62	0.84	0.75	66.55	21.34	19.05
45E	Plug/Male	3/8	1/2	1/2-14	NPTF	Steel	4	2.06	1.15	1	52.32	29.21	25.40
B43	Plug/Male	3/8	3/8	3/8-18	NPTF	Brass	4	1.81	0.91	0.81	45.97	23.11	20.57
41NK*	Plug/Male	3/8	1/4	1/4-18	NPTF	Steel	4	1.63	0.79	0.69	41.40	20.07	17.53

†With Bleeder Ball Check—Reduces Hose Whip *Nickel plated

FLUID TRANSFER
AND HYDRAULIC

PNEUMATIC

SPECIAL APPLICATIONS

DIAGNOSTIC

AGRICULTURE

REFRIGERANT

4000 Series

FLUID TRANSFER
AND HYDRAULIC

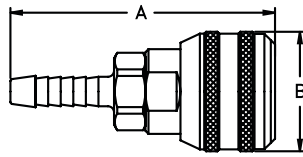

Figure 5

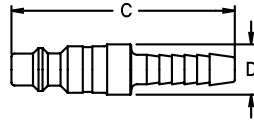

Figure 6

Hose Stem End Connections

Part Number	Coupling Type	Body Size	Hose I.D.	Material	Fig.	Dimensions			
						A	B	A	B
						(in)	(in)	(mm)	(mm)
40400E	Socket/Female	3/8	1/4	Brass	5	2.82	1.38	71.63	35.05
40500E	Socket/Female	3/8	5/16	Brass	5	2.82	1.38	71.63	35.05
40600	Socket/Female	3/8	3/8	Brass	5	2.82	1.38	71.63	35.05
40800	Socket/Female	3/8	1/2	Brass	5	2.82	1.38	71.63	35.05
Part Number	Coupling Type	Body Size	Hose I.D.	Material	Fig.	Dimensions			
						C	D	C	D
						(in)	(in)	(mm)	(mm)
404	Plug/Male	3/8	1/4	Steel	6	2.34	0.72	59.44	18.29
406	Plug/Male	3/8	3/8	Steel	6	2.34	0.63	59.44	16.00
408	Plug/Male	3/8	1/2	Steel	6	2.34	0.81	59.44	20.57
B406E	Plug/Male	3/8	3/8	Brass	6	2.34	0.63	59.44	16.00

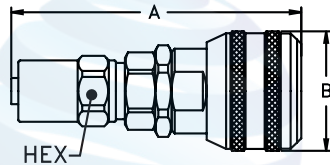

Figure 7

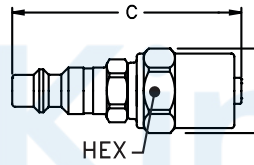

Figure 8

Hose Clamp End Connections

Part Number	Coupling Type	Body Size	Hose I.D.	Hose O.D.	Material	Fig.	Dimensions					
							A	B	Hex	A	B	Hex
							(in)	(in)	(in)	(mm)	(mm)	(mm)
4SB3	Socket/Female	3/8	1/4	1/2	Brass	7	2.92	1.38	0.63	74.17	35.05	16.00
4SB7	Socket/Female	3/8	1/4	5/8	Brass	7	2.92	1.38	0.75	74.17	35.05	19.05
4SC7	Socket/Female	3/8	5/16	5/8	Brass	7	2.98	1.38	0.75	75.69	35.05	19.05
4SD7	Socket/Female	3/8	3/8	5/8	Brass	7	3.04	1.38	0.75	77.22	35.05	19.05
4SD9	Socket/Female	3/8	3/8	11/16	Brass	7	3.04	1.38	0.81	77.22	35.05	20.57
4SD11	Socket/Female	3/8	3/8	3/4	Brass	7	3.04	1.38	0.88	77.22	35.05	22.35
4SP13	Socket/Female	3/8	1/2	13/16	Brass	7	3.67	1.38	0.94	93.22	35.05	23.88
4SP15	Socket/Female	3/8	1/2	7/8	Brass	7	3.67	1.38	1.00	93.22	35.05	25.40
Part Number	Coupling Type	Body Size	Hose I.D.	Hose O.D.	Material	Fig.	Dimensions					
							C	D	Hex	C	D	Hex
							(in)	(in)	(in)	(mm)	(mm)	(mm)
4PB3	Plug/Male	3/8	1/4	1/2	Steel	8	2.44	0.70	0.63	61.98	17.78	16.00
4PB7	Plug/Male	3/8	1/4	5/8	Steel	8	2.44	0.84	0.75	61.98	21.34	19.05
4PD7	Plug/Male	3/8	3/8	5/8	Steel	8	2.56	0.84	0.75	65.02	21.34	19.05
4PD9	Plug/Male	3/8	3/8	11/16	Steel	8	2.56	0.91	0.81	65.02	23.11	20.57
4PD11	Plug/Male	3/8	3/8	3/4	Steel	8	2.56	0.98	0.88	65.02	24.89	22.35
4PD15	Plug/Male	3/8	3/8	7/8	Steel	8	2.56	1.12	1.00	65.02	28.45	25.40
4PP13	Plug/Male	3/8	1/2	13/16	Steel	8	3.25	1.05	0.94	82.55	26.67	23.88
4PP15	Plug/Male	3/8	1/2	7/8	Steel	8	3.25	1.12	1.00	82.55	28.45	25.40
4PP19	Plug/Male	3/8	1/2	1	Steel	8	3.25	1.26	1.13	82.55	32.00	28.70
4PB5	Plug/Male	3/8	1/4	9/16	Steel	8	2.44	0.77	0.69	61.98	19.56	17.53

PNEUMATIC

SPECIAL APPLICATIONS

DIAGNOSTIC

AGRICULTURE

REFRIGERANT

5000 Series

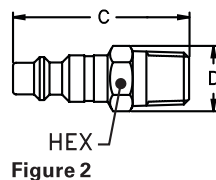
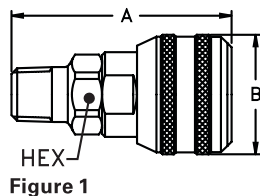

Male End Connections

Part Number	Coupling Type	Body Size	Port Size	Thread	Type	Material	Fig.	Dimensions			A	B	Hex
								A	B	Hex			
50100	Socket/Female	1/2	1/4	1/4-18	NPTF	Brass	1	2.78	1.50	1.00	70.61	38.10	25.40
5100E	Socket/Female	1/2	3/8	3/8-18	NPTF	Brass	1	2.79	1.50	1.00	70.87	38.10	25.40
5300E	Socket/Female	1/2	1/2	1/2-14	NPTF	Brass	1	2.98	1.50	1.00	75.69	38.10	25.40
5500	Socket/Female	1/2	3/4	3/4-14	NPTF	Brass	1	2.98	1.50	1.06	75.69	38.10	26.92
Part Number	Coupling Type	Body Size	Port Size	Thread	Type	Material	Fig.	Dimensions			C	D	Hex
								C	D	Hex			
50E	Plug/Male	1/2	1/4	1/4-18	NPTF	Steel	2	2.25	0.79	0.69	57.15	20.07	17.53
50G†	Plug/Male	1/2	1/4	1/4-18	NPTF	Steel	2	2.90	0.98	0.88	73.66	24.89	22.35
52	Plug/Male	1/2	3/8	3/8-18	NPTF	Steel	2	2.25	0.87	0.75	57.15	22.10	19.05
52G†	Plug/Male	1/2	3/8	3/8-18	NPTF	Steel	2	2.90	0.98	0.88	73.66	24.89	22.35
54E	Plug/Male	1/2	1/2	1/2-14	NPTF	Steel	2	2.44	1.01	0.88	61.98	25.65	22.35
54G†	Plug/Male	1/2	1/2	1/2-14	NPTF	Steel	2	3.09	0.98	0.88	78.49	24.89	22.35
56	Plug/Male	1/2	3/4	3/4-14	NPTF	Steel	2	2.50	1.23	1.06	63.50	31.24	26.92
56G†	Plug/Male	1/2	3/4	3/4-14	NPTF	Steel	2	3.14	1.19	1.06	79.76	30.23	26.92
B52	Plug/Male	1/2	3/8	3/8-18	NPTF	Brass	2	2.25	0.87	0.75	57.15	22.10	19.05
B54	Plug/Male	1/2	1/2	1/2-14	NPTF	Brass	2	2.44	1.01	0.88	61.98	25.65	22.35

†With Bleeder Ball Check—Reduces Hose Whip

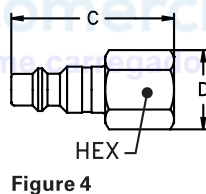
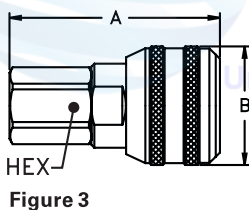

Female End Connections

Part Number	Coupling Type	Body Size	Port Size	Thread	Type	Material	Fig.	Dimensions			A	B	Hex
								A	B	Hex			
5000A	Socket/Female	1/2	1/4	1/4-18	NPTF	Brass	3	2.72	1.50	1.00	69.09	38.10	25.40
5000	Socket/Female	1/2	3/8	3/8-18	NPTF	Brass	3	2.79	1.50	1.00	70.87	38.10	25.40
5200	Socket/Female	1/2	1/2	1/2-14	NPTF	Brass	3	3.07	1.50	1.00	77.98	38.10	25.40
5400E	Socket/Female	1/2	3/4	3/4-14	NPTF	Brass	3	3.10	1.50	1.19	78.74	38.10	30.23
Part Number	Coupling Type	Body Size	Port Size	Thread	Type	Material	Fig.	Dimensions			C	D	Hex
								C	D	Hex			
53A	Plug/Male	1/2	1/4	1/4-18	NPTF	Steel	4	1.92	0.79	0.69	48.77	20.07	17.53
53	Plug/Male	1/2	3/8	3/8-18	NPTF	Steel	4	2.06	0.94	0.81	52.32	23.88	20.57
53G†	Plug/Male	1/2	3/8	3/8-18	NPTF	Steel	4	2.9	0.98	0.88	73.66	24.89	22.35
55	Plug/Male	1/2	1/2	1/2-14	NPTF	Steel	4	2.34	1.15	1	59.44	29.21	25.40
55G†	Plug/Male	1/2	1/2	1/2-14	NPTF	Steel	4	3.17	1.15	1.00	80.52	29.21	25.40
57	Plug/Male	1/2	3/4	3/4-14	NPTF	Steel	4	2.44	1.37	1.19	61.98	34.80	30.23

†With Bleeder Ball Check—Reduces Hose Whip

FLUID TRANSFER
AND HYDRAULIC

PNEUMATIC

SPECIAL APPLICATIONS

DIAGNOSTIC

AGRICULTURE

REFRIGERANT

5000 Series

FLUID TRANSFER
AND HYDRAULIC

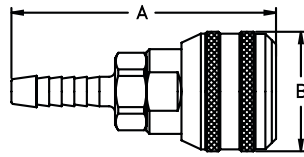

Figure 5

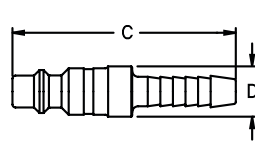

Figure 6

Hose Stem End Connections

Part Number	Coupling Type	Body Size	Hose I.D.	Material	Fig.	Dimensions		A	B
						A	B		
						(in)	(in)	(mm)	(mm)
50400	Socket/Female	1/2	1/4	Brass	5	3.29	1.50	83.57	38.10
5700E	Socket/Female	1/2	3/8	Brass	5	3.33	1.50	84.58	38.10
5800E	Socket/Female	1/2	1/2	Brass	5	3.25	1.50	82.55	38.10
5900	Socket/Female	1/2	3/4	Brass	5	4.10	1.50	104.14	38.10
Part Number	Coupling Type	Body Size	Hose I.D.	Material	Fig.	Dimensions		C	D
						C	D		
						(in)	(in)	(mm)	(mm)
585	Plug/Male	1/2	5/16	Steel	6	2.66	0.69	67.56	17.53
585G†	Plug/Male	1/2	5/16	Brass	6	3.37	0.98	85.60	24.89
59	Plug/Male	1/2	3/8	Steel	6	2.66	0.69	67.56	17.53
59G†	Plug/Male	1/2	3/8	Brass	6	3.37	0.98	85.60	24.89
60	Plug/Male	1/2	1/2	Steel	6	2.66	0.75	67.56	19.05
60G†	Plug/Male	1/2	1/2	Brass	6	3.37	0.98	85.60	24.89
61E	Plug/Male	1/2	3/4	Steel	6	3.50	1.00	88.90	25.40
61G†	Plug/Male	1/2	3/4	Brass	6	4.22	0.98	107.19	24.89
B60	Plug/Male	1/2	1/2	Brass	6	2.75	0.88	69.85	22.35

†With Bleeder Ball Check—Reduces Hose Whip

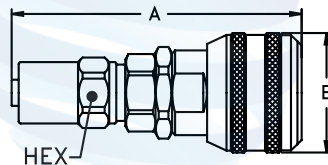

Figure 7

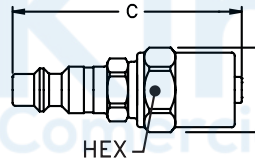

Figure 8

Hose Clamp End Connections

Part Number	Coupling Type	Body Size	Hose I.D.	Hose O.D.	Material	Fig.	Dimensions			A	B	Hex
							A	B	Hex			
							(in)	(in)	(in)	(mm)	(mm)	(mm)
5SD5	Socket/Female	1/2	3/8	9/16	Brass	7	3.50	1.50	0.69	88.90	38.10	17.53
5SD7	Socket/Female	1/2	3/8	5/8	Brass	7	3.50	1.50	0.75	88.90	38.10	19.05
5SD9	Socket/Female	1/2	3/8	11/16	Brass	7	3.50	1.50	0.81	88.90	38.10	20.57
5SD11	Socket/Female	1/2	3/8	3/4	Brass	7	3.50	1.50	0.88	88.90	38.10	22.35
5SP13	Socket/Female	1/2	1/2	13/16	Brass	7	4.10	1.50	0.94	104.14	38.10	23.88
5SP15	Socket/Female	1/2	1/2	7/8	Brass	7	4.10	1.50	1.00	104.14	38.10	25.40
5SR23	Socket/Female	1/2	3/4	1 1/8	Brass	7	4.23	1.50	1.25	107.44	38.10	31.75
5SR25	Socket/Female	1/2	3/4	1 3/16	Brass	7	4.23	1.50	1.31	107.44	38.10	33.27
5SR27	Socket/Female	1/2	3/4	1 1/4	Brass	7	4.23	1.54	1.38	107.44	39.12	35.05
Part Number	Coupling Type	Body Size	Hose I.D.	Hose O.D.	Material	Fig.	Dimensions			C	D	Hex
							C	D	Hex			
							(in)	(in)	(in)	(mm)	(mm)	(mm)
5PB3	Plug/Male	1/2	1/4	1/2	Steel	8	2.81	0.70	0.63	71.37	17.78	16.00
5PB5	Plug/Male	1/2	1/4	9/16	Steel	8	2.81	0.77	0.69	71.37	19.56	17.53
5PB7	Plug/Male	1/2	1/4	5/8	Steel	8	2.81	0.84	0.75	71.37	21.34	19.05
5PD5	Plug/Male	1/2	3/8	9/16	Steel	8	2.94	0.77	0.69	74.68	19.56	17.53
5PD7	Plug/Male	1/2	3/8	5/8	Steel	8	2.94	0.84	0.75	74.68	21.34	19.05
5PD9	Plug/Male	1/2	3/8	11/16	Steel	8	2.94	0.91	0.81	74.68	23.11	20.57
5PD11	Plug/Male	1/2	3/8	3/4	Steel	8	2.94	0.98	0.88	74.68	24.89	22.35
5PD13	Plug/Male	1/2	3/8	13/16	Steel	8	2.94	1.05	0.94	74.68	26.67	23.88
5PP13	Plug/Male	1/2	1/2	13/16	Steel	8	3.62	1.05	0.94	91.95	26.67	23.88
5PP15	Plug/Male	1/2	1/2	7/8	Steel	8	3.62	1.12	1.00	91.95	28.45	25.40
5PR23	Plug/Male	1/2	3/4	1 1/8	Steel	8	3.75	1.40	1.25	95.25	35.56	31.75
5PR25	Plug/Male	1/2	3/4	1 3/16	Steel	8	3.75	1.47	1.31	95.25	37.34	33.27
5PR27	Plug/Male	1/2	3/4	1 1/4	Steel	8	3.75	1.54	1.38	95.25	39.12	35.05

PNEUMATIC

SPECIAL APPLICATIONS

DIAGNOSTIC

AGRICULTURE

REFRIGERANT

6000 Series

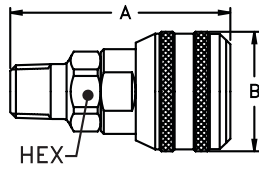

Figure 1

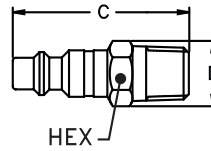

Figure 2

Male End Connections

Part Number	Coupling Type	Body Size	Port Size	Thread	Type	Material	Fig.	Dimensions			A	B	Hex
								A	B	Hex			
								(in)	(in)	(in)	(mm)	(mm)	(mm)
6300	Socket/Female	3/4	1/2	1/2-14	NPTF	Brass	1	2.94	1.90	1.31	74.68	48.26	33.27
6500	Socket/Female	3/4	3/4	3/4-14	NPTF	Brass	1	2.94	1.90	1.31	74.68	48.26	33.27
6700E	Socket/Female	3/4	1	1-11 1/2	NPTF	Brass	1	3.13	1.90	1.31	79.50	48.26	33.27

Part Number	Coupling Type	Body Size	Port Size	Thread	Type	Material	Fig.	Dimensions			C	D	Hex
								C	D	Hex			
								(in)	(in)	(in)	(mm)	(mm)	(mm)
64A	Plug/Male	3/4	1/2	1/2-14	NPTF	Steel	2	2.31	1.15	1.00	58.67	29.21	25.40
64GA†	Plug/Male	3/4	1/2	1/2-14	NPTF	Steel	2	3.26	1.12	1.00	82.80	28.45	25.40
66AE	Plug/Male	3/4	3/4	3/4-14	NPTF	Steel	2	2.38	1.23	1.06	60.45	31.24	26.92
66GA†	Plug/Male	3/4	3/4	3/4-14	NPTF	Steel	2	3.26	1.19	1.06	82.80	30.23	26.92
68A	Plug/Male	3/4	1	1-11 1/2	NPTF	Steel	2	2.56	1.51	1.31	65.02	38.35	33.27
B64A	Plug/Male	3/4	1/2	1/2-14	NPTF	Brass	2	2.31	1.12	1.00	58.67	28.45	25.40
B66A	Plug/Male	3/4	3/4	3/4-14	NPTF	Brass	2	2.38	1.18	1.06	60.45	30.07	26.92

†With Bleeder Ball Check—Reduces Hose Whip

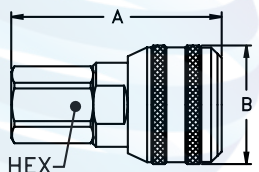

Figure 3

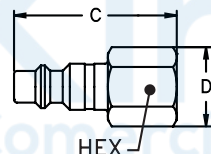

Figure 4

Female End Connections

Part Number	Coupling Type	Body Size	Port Size	Thread	Type	Material	Fig.	Dimensions			A	B	Hex
								A	B	Hex			
								(in)	(in)	(in)	(mm)	(mm)	(mm)
6200E	Socket/Female	3/4	1/2	1/2-14	NPTF	Brass	3	2.85	1.90	1.31	72.39	48.26	33.27
6400E	Socket/Female	3/4	3/4	3/4-14	NPTF	Brass	3	3.00	1.90	1.31	76.20	48.26	33.27
6600E	Socket/Female	3/4	1	1-11 1/2	NPTF	Brass	3	3.19	1.90	1.56	81.03	48.26	39.62

Part Number	Coupling Type	Body Size	Port Size	Thread	Type	Material	Fig.	Dimensions			C	D	Hex
								C	D	Hex			
								(in)	(in)	(in)	(mm)	(mm)	(mm)
65A	Plug/Male	3/4	1/2	1/2-14	NPTF	Steel	4	2.22	1.15	1.00	56.39	29.21	25.40
65GAS†	Plug/Male	3/4	1/2	1/2-14	NPTF	Steel	4	3.35	1.12	1.00	85.09	28.45	25.40
67A	Plug/Male	3/4	3/4	3/4-14	NPTF	Steel	4	2.22	1.33	1.19	56.39	33.78	30.23
67GAS†	Plug/Male	3/4	3/4	3/4-14	NPTF	Steel	4	3.38	1.33	1.19	85.85	33.78	30.23
69A	Plug/Male	3/4	1	1-11 1/2	NPTF	Steel	4	2.41	1.80	1.56	61.21	45.72	39.62

†With Bleeder Ball Check—Reduces Hose Whip

FLUID TRANSFER AND HYDRAULIC

PNEUMATIC

SPECIAL APPLICATIONS

DIAGNOSTIC

AGRICULTURE

REFRIGERANT

6000 Series

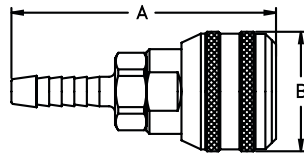

Figure 5

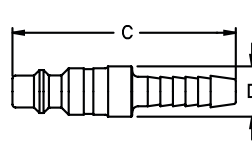

Figure 6

Hose Stem End Connections

Part Number	Coupling Type	Body Size	Hose I.D.	Material	Fig.	Dimensions			
						A	B	A	B
						(in)	(in)	(mm)	(mm)
6800E	Socket/Female	3/4	1/2	Brass	5	3.21	1.88	81.53	47.75
6900	Socket/Female	3/4	3/4	Brass	5	4.06	1.88	103.12	47.75
7000E	Socket/Female	3/4	1	Brass	5	4.07	1.88	103.38	47.75

Part Number	Coupling Type	Body Size	Hose I.D.	Material	Fig.	Dimensions			
						C	D	C	D
						(in)	(in)	(mm)	(mm)
70A	Plug/Male	3/4	1/2	Steel	6	2.53	0.94	64.26	23.88
70GA†	Plug/Male	3/4	1/2	Steel	6	3.53	1.12	89.66	28.45
71A	Plug/Male	3/4	3/4	Steel	6	3.44	1.06	87.38	26.92
71GA†	Plug/Male	3/4	3/4	Steel	6	4.38	1.12	111.25	28.45
72A	Plug/Male	3/4	1	Steel	6	3.44	1.31	87.38	33.27
B71A	Plug/Male	3/4	3/4	Steel	6	3.44	1.06	87.38	26.92

†With Bleeder Ball Check—Reduces Hose Whip

Dust Caps and Dust Plugs

Series	Dust Cap		Dust Plug	
	Metal	Vinyl	Metal	Vinyl
3000	PDC3000*	—	SDC3000*	PSDC1HK
4000	—	—	—	PSDC2HK
5000	—	PPDC2HK	—	—
6000	—	PPDC3HK	—	—

*Brass



FLUID TRANSFER AND HYDRAULIC

PNEUMATIC

SPECIAL APPLICATIONS

DIAGNOSTIC

AGRICULTURE

REFRIGERANT

Auto-Flo 23/24 Series



Eaton's Auto-Flo 23/24 Series of pneumatic couplings were designed with high flow and easy automatic connection for compressed air in mind. The universal design makes the Auto-Flo an extremely flexible coupling series.

Product Features

- Auto-Flo 23 is the first automatic universal quick disconnect coupling designed to operate with Industrial, ARO 210 and Tru-Flate Interchange plugs/males
- Auto-Flo 24 operates with CEJN 320 and Rectus 25 Interchange plugs/males
- Easy, automatic, push-to-connect design provides instantaneous connection and disconnection of lines, plus automatic shut-off of socket/female end of line
- Sleeve guard protects against accidental disconnection
- Standard body material: Brass
- Standard seal material: Buna-N

Physical Characteristics

Series	Max. Operating Pressure		Min. Burst Pressure		Rated Flow	
	(bar)	(psi)	(bar)	(psi)	(lpm)	scfm
Auto-Flo 23	10	150	40	600	792	28
Auto-Flo 24	10	150	40	600	1,274	45

Applications & Markets

- General Pneumatics
- Air Tools
- Construction

Interchangeability

Auto-Flo 23	Auto-Flo 24
US Industrial Interchange	(Euro Interchange)
ISO 6150 Series B	
A-A-59439 (former MIL-C-4109)	CEJN 320
Tru-Flate Interchange	RECTUS 25
ARO 210 Interchange	

Flow Data

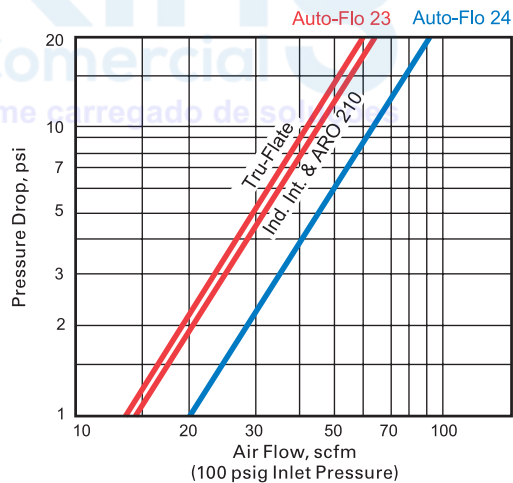

Auto-Flo 23 Series

FLUID TRANSFER
AND HYDRAULIC

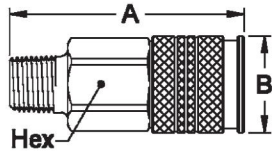

Figure 1

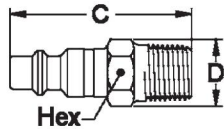

Figure 2

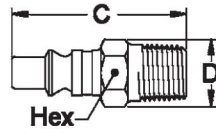

Figure 3 (ARO 210)

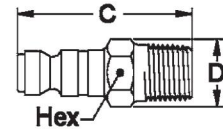

Figure 4 (Tru-Flate)

Male End Connections

Part Number	Coupling Type	Body Size	Port Size	Thread	Type	Material	Fig.	Dimensions			A	B	Hex
								A	B	Hex			
B23AS25M	Socket/Female	1/4	1/4	1/4-18	NPTF	Brass	1	(in)	(in)	(in)	(mm)	(mm)	(mm)
B23AS25MBST	Socket/Female	1/4	1/4	1/4-19	BSPT	Brass	1	2.23	0.96	0.81	56.64	24.38	20.57
B23AS37M	Socket/Female	1/4	3/8	3/8-18	NPTF	Brass	1	2.23	0.96	0.81	56.64	24.38	20.57
B23AS37MBST	Socket/Female	1/4	3/8	3/8-19	BSPT	Brass	1	2.23	0.96	0.81	56.64	24.38	20.57
B23AS50MBST	Socket/Female	1/4	1/2	1/2-14	BSPT	Brass	1	2.23	0.96	0.88	56.64	24.38	22.35

Part Number	Coupling Type	Body Size	Port Size	Thread	Type	Material	Fig.	Dimensions			C	D	Hex
								C	D	Hex			
10	Plug/Male	1/4	1/4	1/4-18	NPTF	Steel	2	(in)	(in)	(in)	(mm)	(mm)	(mm)
10C§	Plug/Male	1/4	1/4	1/4-18	NPTF	Steel	2	1.75	0.62	0.56	44.45	15.75	14.22
10G†	Plug/Male	1/4	1/4	1/4-18	NPTF	Steel	2	1.75	0.65	0.56	44.45	16.51	14.22
12E	Plug/Male	1/4	1/8	1/8-27	NPTF	Steel	2	1.59	0.58	0.5	40.39	14.73	12.70
12G†	Plug/Male	1/4	1/8	1/8-27	NPTF	Steel	2	2.38	0.77	0.69	60.45	19.56	17.53
14	Plug/Male	1/4	3/8	3/8-18	NPTF	Steel	2	1.75	0.79	0.69	44.45	20.07	17.53
14G†	Plug/Male	1/4	3/8	3/8-18	NPTF	Steel	2	2.53	0.77	0.69	64.26	19.56	17.53
B10	Plug/Male	1/4	1/4	1/4-18	NPTF	Brass	2	1.75	0.62	0.56	44.45	15.75	14.22
LL10	Plug/Male	1/4	1/4	1/4-18	NPTF	Stainless	2	1.75	0.62	0.56	44.45	15.75	14.22
2607	Plug/Male	1/4	1/8	1/8-27	NPTF	Steel	3	1.42	0.58	0.5	36.07	14.73	12.70
2608	Plug/Male	1/4	1/4	1/4-18	NPTF	Steel	3	1.68	0.65	0.56	42.67	16.51	14.22
2608B	Plug/Male	1/4	1/4	1/4-19	BSPT	Steel	3	1.68	0.65	0.56	42.67	16.51	14.22
20AP37M	Plug/Male	1/4	3/8	3/8-18	NPTF	Steel	3	1.68	0.79	0.69	42.67	20.07	17.53
21AP25M	Plug/Male	1/4	1/4	1/4-18	NPTF	Steel	4	1.65	0.65	0.56	41.91	16.51	14.22
10NK*	Plug/Male	1/4	1/4	1/4-18	NPTF	Steel	2	1.75	0.62	0.56	44.45	15.75	14.22

§With Ball Check †With Bleeder Ball Check—Reduces Hose Whip *Nickel plated

PNEUMATIC

SPECIAL APPLICATIONS

DIAGNOSTIC

AGRICULTURE

REFRIGERANT

Auto-Flo 23 Series

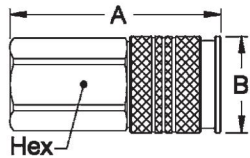

Figure 1

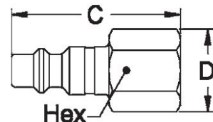

Figure 2

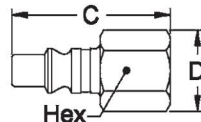

Figure 3 (ARO 210)

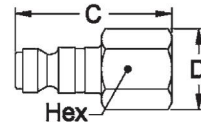

Figure 4 (Tru-Flate)

Female End Connections

Part Number	Coupling Type	Body Size	Port Size	Thread	Type	Material	Fig.	Dimensions			A	B	Hex
								A	B	Hex			
								(in)	(in)	(in)	(mm)	(mm)	(mm)
B23AS25F	Socket/Female	1/4	1/4	1/4-18	NPTF	Brass	1	2.02	0.96	0.81	51.31	24.38	20.57
B23AS25FBS	Socket/Female	1/4	1/4	1/4-19	BSPP	Brass	1	2.02	0.96	0.81	51.31	24.38	20.57
B23AS37F	Socket/Female	1/4	3/8	3/8-18	NPTF	Brass	1	2.02	0.96	0.81	51.31	24.38	20.57
B23AS37FBS	Socket/Female	1/4	3/8	3/8-19	BSPP	Brass	1	2.02	0.96	0.81	51.31	24.38	20.57

Part Number	Coupling Type	Body Size	Port Size	Thread	Type	Material	Fig.	Dimensions			C	D	Hex
								C	D	Hex			
								(in)	(in)	(in)	(mm)	(mm)	(mm)
11	Plug/Male	1/4	1/4	1/4-18	NPTF	Steel	2	1.63	0.79	0.69	41.40	20.07	17.53
11G†	Plug/Male	1/4	1/4	1/4-18	NPTF	Steel	2	2.44	0.77	0.69	61.98	19.56	17.53
13	Plug/Male	1/4	1/8	1/8-27	NPTF	Steel	2	1.47	0.65	0.56	37.34	16.51	14.22
15E	Plug/Male	1/4	3/8	3/8-18	NPTF	Steel	2	1.69	0.94	0.81	42.93	23.88	20.57
11B	Plug/Male	1/4	1/4	1/4-18	NPTF	Brass	2	1.63	0.79	0.69	41.40	20.07	17.53
LL11	Plug/Male	1/4	1/4	1/4-18	NPTF	Stainless	2	1.63	0.79	0.69	41.40	20.07	17.53
2609	Plug/Male	1/4	1/4	1/4-18	NPTF	Steel	3	1.55	0.79	0.69	39.37	20.07	17.53
2609B	Plug/Male	1/4	1/4	1/4-19	BSPP	Steel	3	1.52	0.79	0.69	38.61	20.07	17.53
20AP37F	Plug/Male	1/4	3/8	3/8-18	NPTF	Steel	3	1.61	0.94	0.81	40.89	23.88	20.57
21AP25F	Plug/Male	1/4	1/4	1/4-18	NPTF	Steel	4	1.53	0.79	0.69	38.86	20.07	17.53
11NK*	Plug/Male	1/4	1/4	1/4-18	NPTF	Steel	2	1.63	0.79	0.69	41.40	20.07	17.53

†With Bleeder Ball Check—Reduces Hose Whip *Nickel plated

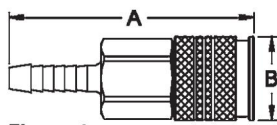

Figure 1

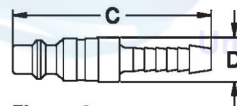

Figure 2

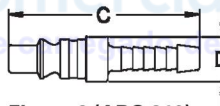

Figure 3 (ARO 210)

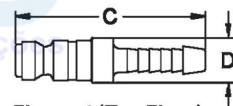

Figure 4 (Tru-Flate)

Hose Stem End Connections

Part Number	Coupling Type	Body Size	Hose I.D.	Material	Fig.	Dimensions		A	B
						A	B		
						(in)	(in)	(mm)	(mm)
B23AS25H	Socket/Female	1/4	1/4	Brass	1	2.76	0.96	70.10	24.38
B23AS31H	Socket/Female	1/4	5/16	Brass	1	2.73	0.96	69.34	24.38
B23AS37H	Socket/Female	1/4	3/8	Brass	1	2.73	0.96	69.34	24.38
B23AS50H	Socket/Female	1/4	1/2	Brass	1	2.7	0.96	68.58	24.38

Part Number	Coupling Type	Body Size	Hose I.D.	Material	Fig.	Dimensions		C	D
						C	D		
						(in)	(in)	(mm)	(mm)
16	Plug/Male	1/4	1/4	Steel	2	2.22	0.5	56.39	12.70
16G†	Plug/Male	1/4	1/4	Steel	2	2.97	0.77	75.44	19.56
16P‡	Plug/Male	1/4	1/4	Steel	2	2.00	0.58	50.80	14.73
17	Plug/Male	1/4	3/8	Steel	2	2.22	0.5	56.39	12.70
17G†	Plug/Male	1/4	3/8	Steel	2	2.96	0.77	75.18	19.56
17P‡	Plug/Male	1/4	3/8	Steel	2	2.06	0.5	52.32	12.70
18E	Plug/Male	1/4	5/16	Steel	2	2.22	0.5	56.39	12.70
B17	Plug/Male	1/4	3/8	Brass	2	2.22	0.5	56.39	12.70
3946	Plug/Male	1/4	1/4	Steel	3	2.14	0.5	54.36	12.70
3947	Plug/Male	1/4	5/16	Steel	3	2.14	0.5	54.36	12.70
22238E	Plug/Male	1/4	3/8	Steel	3	2.14	0.5	54.36	12.70
21AP25H	Plug/Male	1/4	1/4	Steel	4	2.12	0.5	53.85	12.70
16NK*	Plug/Male	1/4	1/4	Steel	2	2.22	0.5	56.39	12.70
17NK*	Plug/Male	1/4	3/8	Steel	2	2.22	0.5	56.39	12.70

†With Bleeder Ball Check—Reduces Hose Whip ‡For use with push-on style hose *Nickel plated

FLUID TRANSFER AND HYDRAULIC

PNEUMATIC

SPECIAL APPLICATIONS

DIAGNOSTIC

AGRICULTURE

REFRIGERANT

Auto-Flo 24 Series

FLUID TRANSFER
AND HYDRAULIC

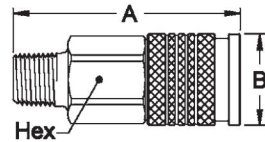

Figure 1

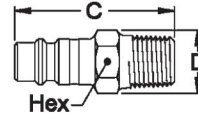

Figure 2

Male End Connections

Part Number	Coupling Type	Body Size	Port Size	Thread	Type	Material	Fig.	Dimensions			A	B	Hex
								A	B	Hex			
								(in)	(in)	(in)	(mm)	(mm)	(mm)
B24AS25M	Socket/Female	1/4	1/4	1/4-18	NPTF	Brass	1	2.27	0.96	0.81	57.66	24.38	20.57

Part Number	Coupling Type	Body Size	Port Size	Thread	Type	Material	Fig.	Dimensions			C	D	Hex
								C	D	Hex			
								(in)	(in)	(in)	(mm)	(mm)	(mm)
24AP25MBST	Plug/Male	1/4	1/4	1/4-19	BSPT	Steel	2	1.62	0.65	0.56	41.15	16.51	14.22
24AP50MBST	Plug/Male	1/4	1/2	1/2-14	BSPT	Steel	2	1.88	1.01	0.88	47.75	25.65	22.35

PNEUMATIC

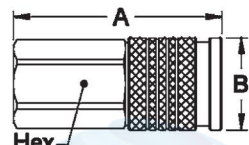

Figure 1

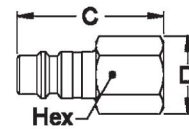

Figure 2

Female End Connections

Part Number	Coupling Type	Body Size	Port Size	Thread	Type	Material	Fig.	Dimensions			A	B	Hex
								A	B	Hex			
								(in)	(in)	(in)	(mm)	(mm)	(mm)
B24AS25F	Socket/Female	1/4	1/4	1/4-18	NPTF	Brass	1	2.06	0.96	0.81	52.32	24.38	20.57
B24AS25FBS	Socket/Female	1/4	1/4	1/4-19	BSPP	Brass	1	2.06	0.96	0.81	52.32	24.38	20.57
B24AS37FBS	Socket/Female	1/4	3/8	3/8-19	BSPP	Brass	1	2.06	0.96	0.81	52.32	24.38	20.57
B24AS50FBS	Socket/Female	1/4	1/2	1/2-14	BSPP	Brass	1	2.38	0.96	1.06	60.45	24.38	26.92

Part Number	Coupling Type	Body Size	Port Size	Thread	Type	Material	Fig.	Dimensions			C	D	Hex
								C	D	Hex			
								(in)	(in)	(in)	(mm)	(mm)	(mm)
24AP25FG	Plug/Male	1/4	1/4	1/4-18	NPTF	Steel	2	1.49	0.79	0.69	37.85	20.07	17.53
24AP25FBS	Plug/Male	1/4	1/4	1/4-19	BSPP	Steel	2	1.46	0.79	0.69	37.08	20.07	17.53

SPECIAL APPLICATIONS

DIAGNOSTIC

AGRICULTURE

REFRIGERANT

Safeline Series



Eaton's Safeline Series is an Industrial Interchange pneumatic coupling with push button safety feature designed for use with compressed air. Two-step disconnect procedure shuts off air supply and releases downstream air pressure before plug can be removed from socket/female, which prevents hose whip.

Product Features

- Safe and easy to connect and disconnect
- Light weight, compact ergonomic design
- Accepts 1/4" ISO 6150 Series B and A-A-59439 plugs/males
- Accepts all US Industrial plugs/males
- Standard body material: Aluminum
- Standard seal material: Buna-N

Physical Characteristics

Series	Max. Operating Pressure		Min. Burst Pressure		Rated Flow	
	(bar)	(psi)	(bar)	(psi)	(lpm)	scfm
GD10500	16	232	64	928	566	20

Applications & Markets

- General Pneumatics
- Air Tools
- Industrial Plants
- Maintenance and Repair

Flow Data

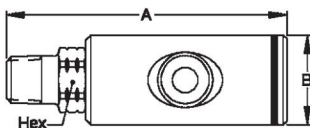
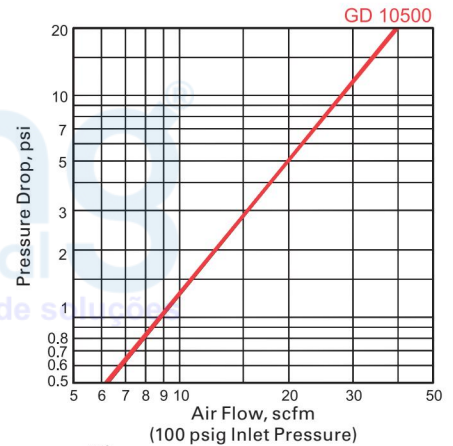

Figure 1

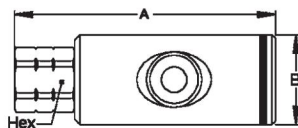

Figure 2

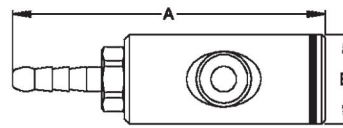

Figure 3

Male End Connections

Part Number	Coupling Type	Body Size	Port Size	Thread	Type	Fig.	Dimensions			A	B	Hex
							A	B	Hex			
							(in)	(in)	(in)	(mm)	(mm)	(mm)
GD1053641	Socket/Female	1/4	1/4	1/4	NPT	1	3.20	1.02	0.67	81.3	25.9	17.0
GD1053683	Socket/Female	1/4	3/8	3/8	NPT	1	3.18	1.02	0.75	80.8	25.9	19.1

Female End Connections

Part Number	Coupling Type	Body Size	Port Size	Thread	Type	Fig.	Dimensions			A	B	Hex
							A	B	Hex			
							(in)	(in)	(in)	(mm)	(mm)	(mm)
GD1052641	Socket/Female	1/4	1/4	1/4	NPT	2	2.98	1.02	0.67	75.7	25.9	17.0
GD1052683	Socket/Female	1/4	3/8	3/8	NPT	2	3.18	1.02	0.87	80.8	25.9	22.1

Hose Stem End Connections

Part Number	Coupling Type	Body Size	Hose I.D.	Fig.	Dimensions			A	B	Hex
					A	B	Hex			
					(in)	(in)	(in)	(mm)	(mm)	(mm)
GD1055601	Socket/Female	1/4	3/8	3	3.58	1.02	0.67	90.9	25.9	17.0

180/280 Series



Eaton's 180/280 series miniature ball lock quick disconnect couplings are designed for use with compressed air, gases and liquids.

Product Features

- Series 180 and 280 sockets/females mate with all Series 180 plugs/males
- Series 180 sockets/females have a tire valve
- Series 280 sockets/females have a 1HK valve, which provides higher flow capacity
- Chrome plating available as well as additional seal options
- Standard body material: Brass
- Standard seal material: Buna-N
- Interchange is proprietary to Eaton

Physical Characteristics

Series	Body Size (in)	Max. Operating Pressure		Min. Burst Pressure		Rated Flow	
		(bar)	(psi)	(bar)	(psi)	(lpm)	(scfm)
180	1/8	48	700	192	2,800	71	2.5
280	1/8	207	3,000	828	1,200	283	10

Applications & Markets

- Recreation and Entertainment
- Breathing Air
- General Pneumatics
- Pharmaceutical
- Laboratory Uses
- Medical

Flow Data

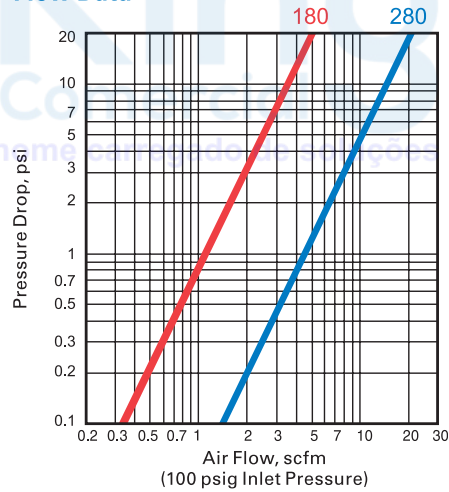

FLUID TRANSFER AND HYDRAULIC

PNEUMATIC

SPECIAL APPLICATIONS

DIAGNOSTIC

AGRICULTURE

REFRIGERANT

180/280 Series

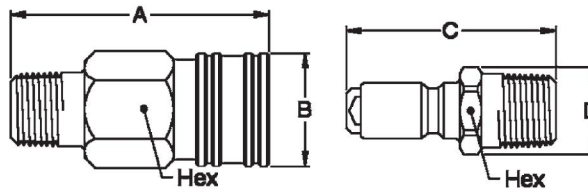

Figure 1

Figure 2

Male End Connections

Part Number	Coupling Type	Body Size	Port Size	Thread	Type	Fig.	Dimensions			A	B	Hex
							A	B	Hex			
							(in)	(in)	(in)	(mm)	(mm)	(mm)
180	Socket/Female	1/8	1/8	1/8-27	NPTF	1	1.42	0.63	0.56	36.1	16.0	14.2
28S25M	Socket/Female	1/8	1/4	1/4-18	NPTF	1	1.39	0.63	0.56	35.3	16.0	14.2

Part Number	Coupling Type	Body Size	Port Size	Thread	Type	Fig.	Dimensions			C	D	Hex
							C	D	Hex			
							(in)	(in)	(in)	(mm)	(mm)	(mm)
185E	Plug/Male	1/8	1/8	1/8-27	NPTF	2	1.16	0.51	0.44	29.5	13.0	11.2
186	Plug/Male	1/8	1/4	1/4-18	NPTF	2	1.44	0.63	0.56	36.6	16.0	14.2

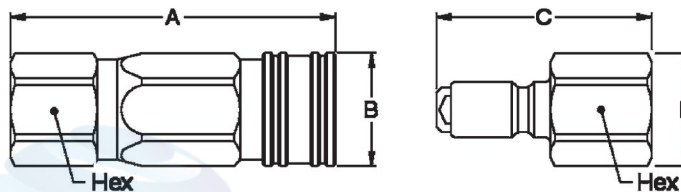

Figure 1

Figure 2

Female End Connections

Part Number	Coupling Type	Body Size	Port Size	Thread	Type	Fig.	Dimensions			A	B	Hex
							A	B	Hex			
							(in)	(in)	(in)	(mm)	(mm)	(mm)
28S12F	Socket/Female	1/8	1/8	1/8-27	NPTF	1	1.79	0.63	0.56	45.5	16.0	14.2

Part Number	Coupling Type	Body Size	Port Size	Thread	Type	Fig.	Dimensions			C	D	Hex
							C	D	Hex			
							(in)	(in)	(in)	(mm)	(mm)	(mm)
183	Plug/Male	1/8	1/8	1/8-27	NPTF	2	1.19	0.58	0.50	30.2	14.7	12.7



Figure 1

Figure 2

Hose Stem End Connections

Part Number	Coupling Type	Body Size	Hose I.D.	Fig.	Dimensions			
					C	D	C	D
					(in)	(in)	(mm)	(mm)
187	Plug/Male	1/8	1/8	1	1.25	0.38	31.8	9.7
189	Plug/Male	1/8	3/16	2	1.50	0.38	38.1	9.7

FLUID TRANSFER AND HYDRAULIC

PNEUMATIC

SPECIAL APPLICATIONS

DIAGNOSTIC

AGRICULTURE

REFRIGERANT

100 Series



Eaton's 100 Series quick disconnect couplings are designed to prevent the crossing of lines. These couplings are used for compressed air and gases.

Product Features

- Non-interchangeable design prevents crossing of lines
- Standard body material: Brass
- Standard seal material: Buna-N

Physical Characteristics

Series	Body Size	Max. Operating Pressure		Min. Burst Pressure		Rated Flow	
	(in)	(bar)	(psi)	(bar)	(psi)	(lpm)	scfm
100	1/4	24	350	96	2,800	566	20

Applications & Markets

- General Pneumatics
- Industrial Plants

Flow Data

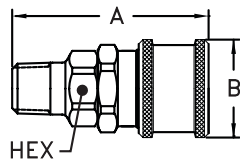
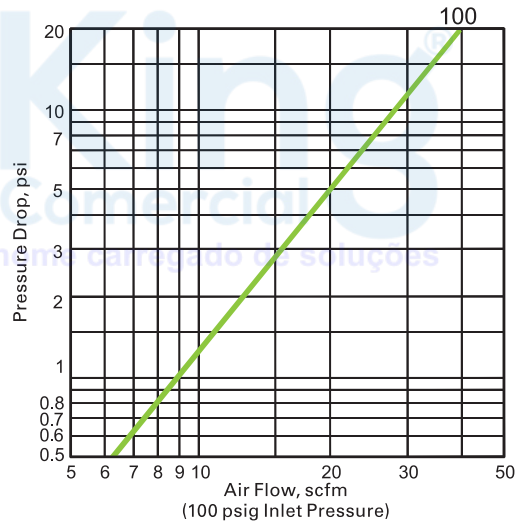

Figure 1

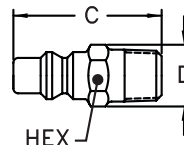

Figure 2

Male End Connections

Part Number	Coupling Type	Body Size	Port Size	Thread	Type	Fig.	Dimensions			A	B	Hex
							A	B	Hex			
101	Socket/Female	1/4	1/8	1/8-27	NPTF	1	1.86	1.03	0.69	47.2	26.2	17.5
103	Socket/Female	1/4	1/4	1/4-18	NPTF	1	2.05	1.03	0.69	52.1	26.2	17.5
105	Socket/Female	1/4	3/8	3/8-18	NPTF	1	2.01	1.03	0.69	51.1	26.2	17.5

Part Number	Coupling Type	Body Size	Port Size	Thread	Type	Fig.	Dimensions			C	D	Hex
							C	D	Hex			
1G1	Plug/Male	1/4	1/8	1/8-27	NPTF	2	1.38	0.65	0.56	35.1	16.5	14.2
1G3E	Plug/Male	1/4	1/4	1/4-18	NPTF	2	1.56	0.65	0.56	39.6	16.5	14.2
1G5E	Plug/Male	1/4	3/8	3/8-18	NPTF	2	1.56	0.79	0.69	39.6	20.1	17.5

100 Series

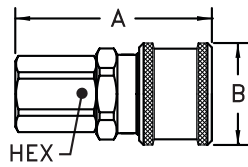

Figure 1

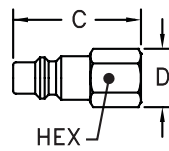

Figure 2

Female End Connections

Part Number	Coupling Type	Body Size	Port Size	Thread	Type	Fig.	Dimensions			A	B	Hex
							A	B	Hex			
							(in)	(in)	(in)	(mm)	(mm)	(mm)
100E	Socket/Female	1/4	1/8	1/8-27	NPTF	1	1.75	1.03	0.69	44.5	26.2	17.5
102E	Socket/Female	1/4	1/4	1/4-18	NPTF	1	1.97	1.03	0.69	50.0	26.2	17.5
104	Socket/Female	1/4	3/8	3/8-18	NPTF	1	2.05	1.03	0.75	52.1	26.2	19.1

Part Number	Coupling Type	Body Size	Port Size	Thread	Type	Fig.	Dimensions			C	D	Hex
							C	D	Hex			
							(in)	(in)	(in)	(mm)	(mm)	(mm)
1G2	Plug/Male	1/4	1/4	1/4-18	NPTF	2	1.43	0.79	0.69	36.3	20.1	17.5

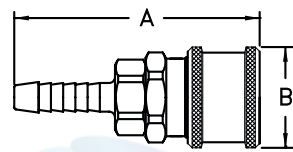

Figure 1

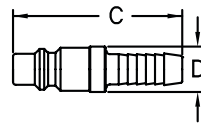

Figure 2

Hose Stem End Connections

Part Number	Coupling Type	Body Size	Hose I.D.	Fig.	Dimensions		A	B
					A	B		
					(in)	(in)	(mm)	(mm)
110E	Socket/Female	1/4	1/4	1	2.49	1.03	63.2	26.2
111E	Socket/Female	1/4	5/16	1	2.49	1.03	63.2	26.2
112E	Socket/Female	1/4	3/8	1	2.49	1.03	63.2	26.2

Part Number	Coupling Type	Body Size	Hose I.D.	Fig.	Dimensions		C	D
					C	D		
					(in)	(in)	(mm)	(mm)
1G10E	Plug/Male	1/4	1/4	2	2.00	0.56	50.8	14.2
1G12E	Plug/Male	1/4	3/8	2	2.03	0.56	51.6	14.2

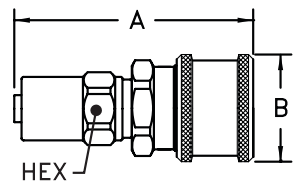

Figure 1

Hose Clamp End Connections

Part Number	Coupling Type	Body Size	Hose I.D.	Hose O.D.	Fig.	Dimensions			A	B	Hex	
						A	B	Hex				
							(in)	(in)	(in)	(mm)	(mm)	(mm)
1GB3	Socket/Female	1/4	1/4	1/2	1	2.58	1.03	0.63	65.5	26.2	16.0	
1GB7	Socket/Female	1/4	1/4	5/8	1	2.58	1.03	0.75	65.5	26.2	19.1	
1GD9	Socket/Female	1/4	3/8	11/16	1	2.70	1.03	0.81	68.6	26.2	20.6	

Dust Caps and Dust Plugs

Series	Dust Cap	Dust Plug
100	PPDC1HK	PSDC1HK



FLUID TRANSFER AND HYDRAULIC

PNEUMATIC

SPECIAL APPLICATIONS

DIAGNOSTIC

AGRICULTURE

REFRIGERANT

600/700 Series



Eaton's 600/700 Series quick connect couplings are designed for use in oxyacetylene service. The 600/700 Series can also be used with compressed air and other gases.

Product Features

- Safety sleeve lock prevents accidental disconnections
- Non-Interchangeable design prevents crossing of lines
- Color coded sleeves for easy identification: -600 green, -700 red
- Designed for use with compressed air and other gases
- OSHA compliant
- Standard body material: Brass
- Standard seal material: Buna-N

Physical Characteristics

Series	Body Size	Max. Operating Pressure		Min. Burst Pressure		Rated Flow	
	(in)	(bar)	(psi)	(bar)	(psi)	(lpm)	scfm
600 & 700	1/4	103	1,500	412	6,000	595	21

Applications & Markets

- Breathing Equipment
- Welding
- Shipyards
- General Pnuematics
- Construction
- Nitrous Oxide
- Series 600 couplings are not to be used with oxygen at pressures exceeding 100 psig.
- Series 700 couplings are not to be used with acetylene at pressures exceeding 15 psig.

Flow Data

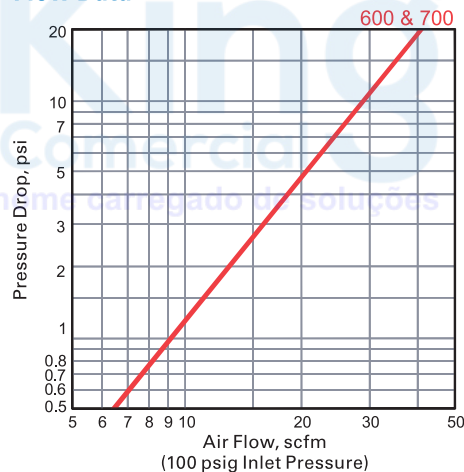

! Series 600 and 700 couplings with sleeve lock feature comply with OSHA requirements,* which state couplings shall be a type that cannot be unlocked or disconnected by means of straight pull without rotary motion.

! WARNING

Oxygen increases combustibility. Fire and explosion could occur causing severe bodily injury or death. Be sure to select the proper coupling for your application and use it only within the specified service pressure range.

*Series 600 and 700 couplings with sleeve lock feature comply with O.S.H.A. requirements, Sec. 1915.35 (f)(5), 1916.35 (f)(5), 1917.35 (f)(5), and 1926.350 (f)(5).

600 Series

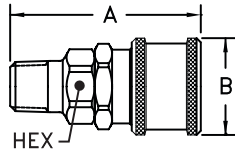

Figure 1

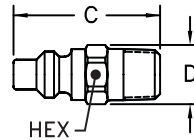

Figure 2

Male End Connections

Part Number Standard*	Oxygen Service	Coupling Type	Body Size	Port Size	Thread	Type	Material	Fig.	Dimensions					
									A	B	Hex	A	B	Hex
									(in)	(in)	(in)	(mm)	(mm)	(mm)
GR601	GR601SL	Socket/Female	1/4	1/8	1/8-27	NPTF	Brass	1	1.84	1.00	0.69	46.7	25.4	17.5
GR603	GR603SL	Socket/Female	1/4	1/4	1/4-18	NPTF	Brass	1	2.03	1.00	0.69	51.6	25.4	17.5
GR604R†	GR604RSL	Socket/Female	1/4	9/16	9/16-18	UNF	Brass	1	1.92	1.00	0.69	48.8	25.4	17.5
GR605	GR605SL	Socket/Female	1/4	3/8	3/8-18	NPTF	Brass	1	1.99	1.00	0.69	50.5	25.4	17.5

Part Number Standard*	Oxygen Service	Coupling Type	Body Size	Port Size	Thread	Type	Material	Fig.	Dimensions					
									C	D	Hex	C	D	Hex
									(in)	(in)	(in)	(mm)	(mm)	(mm)
01A	—	Plug/Male	1/4	1/8	1/8-27	NPTF	Brass	2	1.41	0.63	0.56	35.8	16.0	14.2
03A	—	Plug/Male	1/4	1/4	1/4-18	NPTF	Brass	2	1.56	0.63	0.56	39.6	16.0	14.2
04R†	—	Plug/Male	1/4	9/16	9/16-18	UNF	Brass	2	1.41	0.63	0.56	35.8	16.0	14.2

†R.H. Thread—30° Female Flare
*Without sleeve lock

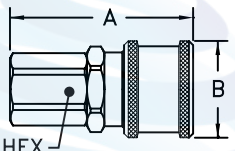

Figure 1

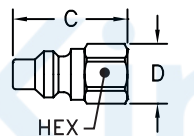

Figure 2

Female End Connections

Part Number Standard*	Oxygen Service	Coupling Type	Body Size	Port Size	Thread	Type	Material	Fig.	Dimensions					
									A	B	Hex	A	B	Hex
									(in)	(in)	(in)	(mm)	(mm)	(mm)
GR600	GR600SL	Socket/Female	1/4	1/8	1/8-27	NPTF	Brass	1	1.73	1.00	0.69	43.9	25.4	17.5
GR602	GR602SL	Socket/Female	1/4	1/4	1/4-18	NPTF	Brass	1	1.95	1.00	0.69	49.5	25.4	17.5
GR604	GR604SL	Socket/Female	1/4	3/8	3/8-18	NPTF	Brass	1	2.03	1.00	0.69	51.6	25.4	17.5
GR605R†	GR605RSL	Socket/Female	1/4	9/16	9/16-18	UNF	Brass	1	1.95	1.00	0.69	49.5	25.4	17.5

Part Number Standard*	Oxygen Service	Coupling Type	Body Size	Port Size	Thread	Type	Material	Fig.	Dimensions					
									C	D	Hex	C	D	Hex
									(in)	(in)	(in)	(mm)	(mm)	(mm)
00A	—	Plug/Male	1/4"	1/8	1/8-27	NPTF	Brass	2	1.22	0.63	0.56	31.0	16.0	14.2
02A	—	Plug/Male	1/4"	1/4	1/4-18	NPTF	Brass	2	1.41	0.77	0.69	35.8	19.6	17.5
05R†	—	Plug/Male	1/4	9/16	9/16-18	UNF	Brass	2	1.38	0.77	0.69	35.1	19.6	17.5

†R.H. Thread—Inverted Flare
*Without sleeve lock

FLUID TRANSFER
AND HYDRAULIC

PNEUMATIC

SPECIAL APPLICATIONS

DIAGNOSTIC

AGRICULTURE

REFRIGERANT

600 Series

FLUID TRANSFER
AND HYDRAULIC

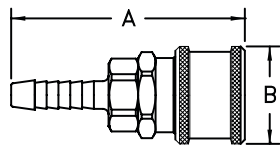

Figure 1

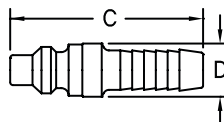
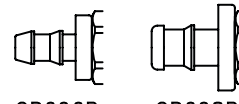

Figure 2



GR606P
Figure 1A

GR608P

Hose Stem End Connections

Part Number Standard*	Oxygen Service	Coupling Type	Body Size	Hose I.D.	Material	Fig.	Dimensions			
							A	B	A	B
							(in)	(in)	(mm)	(mm)
GR606	GR606SL	Socket/Female	1/4	1/4	Brass	1	2.47	1.00	62.74	25.40
GR606P§	GR606PSL§	Socket/Female	1/4	1/4	Brass	1, 1A	2.24	1.00	56.90	25.40
GR607	GR607SL	Socket/Female	1/4	5/16	Brass	1	2.47	1.00	62.74	25.40
GR608	GR608SL	Socket/Female	1/4	3/8	Brass	1	2.47	1.00	62.74	25.40
GR608P§	—	Socket/Female	1/4	3/8	Brass	1, 1A	2.31	1.00	58.67	25.40

Part Number Standard*	Oxygen Service	Coupling Type	Body Size	Hose I.D.	Material	Fig.	Dimensions			
							C	D	C	D
							(in)	(in)	(mm)	(mm)
07A	—	Plug/Male	1/4	1/4	Brass	2	2.03	0.56	51.56	14.22
08A	—	Plug/Male	1/4	5/16	Brass	2	2.03	0.56	51.56	14.22
09A	—	Plug/Male	1/4	3/8	Brass	2	2.04	0.56	51.82	14.22

§For use with push-on style hose
*Without sleeve lock

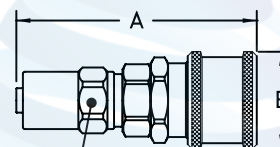

Figure 1

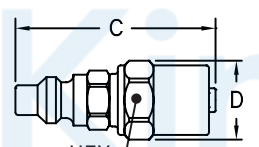

Figure 2

Hose Clamp End Connections

Part Number Standard*	Oxygen Service	Coupling Type	Body Size	Hose I.D.	Hose O.D.	Material	Fig.	Dimensions					
								A	B	Hex	A	B	Hex
								(in)	(in)	(in)	(mm)	(mm)	(mm)
GR60B3	GR60B3SL	Socket/Female	1/4	1/4	1/2	Brass	1	2.56	1.00	0.63	65.0	25.4	16.0
GR60B5	GR60B5SL	Socket/Female	1/4	1/4	9/16	Brass	1	2.56	1.00	0.69	65.0	25.4	17.5
GR60B7	GR60B7SL	Socket/Female	1/4	1/4	5/8	Brass	1	2.56	1.00	0.75	65.0	25.4	19.1
GR60C5	—	Socket/Female	1/4	5/16	9/16	Brass	1	2.62	1.00	0.69	66.5	25.4	17.5
GR60D7	—	Socket/Female	1/4	3/8	5/8	Brass	1	2.68	1.00	0.75	68.1	25.4	19.1
GR60D9	—	Socket/Female	1/4	3/8	11/16	Brass	1	2.68	1.00	0.81	68.1	25.4	20.6
GR60D11	—	Socket/Female	1/4	3/8	3/4	Brass	1	2.68	1.00	0.88	68.1	25.4	22.4

Part Number Standard*	Oxygen Service	Coupling Type	Body Size	Hose I.D.	Hose O.D.	Material	Fig.	Dimensions					
								C	D	Hex	C	D	Hex
								(in)	(in)	(in)	(mm)	(mm)	(mm)
6B3	—	Plug/Male	1/4	1/4	1/2	Brass	2	2.13	0.70	0.63	54.1	17.8	16.0
6B5	—	Plug/Male	1/4	1/4	9/16	Brass	2	2.13	0.77	0.69	54.1	19.6	17.5
6B7	—	Plug/Male	1/4	1/4	5/8	Brass	2	2.13	0.84	0.75	54.1	21.3	19.1
6D7	—	Plug/Male	1/4	3/8	5/8	Brass	2	2.25	0.84	0.75	57.2	21.3	19.1
6D9	—	Plug/Male	1/4	3/8	11/16	Brass	2	2.25	0.91	0.81	57.2	23.1	20.6
6D11	—	Plug/Male	1/4	3/8	3/4	Brass	2	2.25	0.98	0.88	57.2	24.9	22.4

*Without sleeve lock

PNEUMATIC

SPECIAL APPLICATIONS

DIAGNOSTIC

AGRICULTURE

REFRIGERANT

700 Series

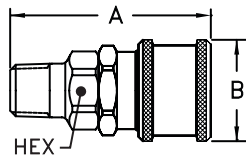

Figure 1

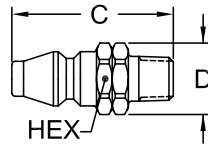

Figure 2

Male End Connections

Part Number Standard*	Acetylene Service	Coupling Type	Body Size	Port Size	Thread	Type	Material	Fig.	Dimensions			A	B	Hex
									A	B	Hex			
RD701	—	Socket/Female	1/4	1/8	1/8-27	NPTF	Brass	1	1.85	1.00	0.69	47.0	25.4	17.5
RD703	RD703SL	Socket/Female	1/4	1/4	1/4-18	NPTF	Brass	1	2.04	1.00	0.69	51.8	25.4	17.5
RD704L†	RD704LSL	Socket/Female	1/4	9/16	9/16-18	UNF	Brass	1	1.93	1.00	0.69	49.0	25.4	17.5
RD705	RD705SL	Socket/Female	1/4	3/8	3/8-18	NPTF	Brass	1	2.00	1.00	0.69	50.8	25.4	17.5

Part Number Standard*	Acetylene Service	Coupling Type	Body Size	Port Size	Thread	Type	Material	Fig.	Dimensions			C	D	Hex
									C	D	Hex			
A1	—	Plug/Male	1/4	1/8	1/8-27	NPTF	Brass	2	1.47	0.63	0.56	37.3	16.0	14.2
A3P	—	Plug/Male	1/4	1/4	1/4-18	NPTF	Brass	2	1.63	0.63	0.56	41.4	16.0	14.2
A4L†	—	Plug/Male	1/4	9/16	9/16-18	UNF	Brass	2	1.50	0.63	0.56	38.1	16.0	14.2

†L.H. Thread—30° Female Flare
*Without sleeve lock

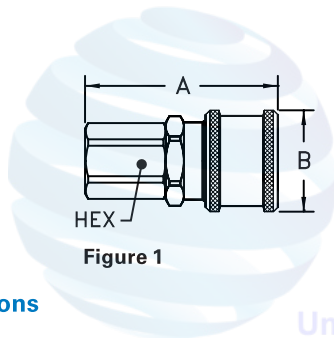

Figure 1

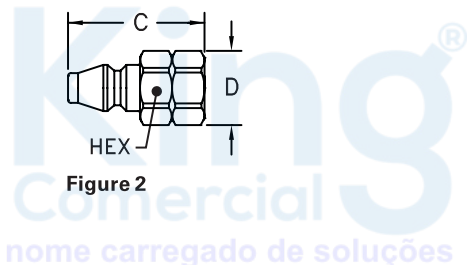

Figure 2

Female End Connections

Part Number Standard*	Acetylene Service	Coupling Type	Body Size	Port Size	Thread	Type	Material	Fig.	Dimensions			A	B	Hex
									A	B	Hex			
RD700	RD700SL	Socket/Female	1/4	1/8	1/8-27	NPTF	Brass	1	1.74	1.00	0.69	44.2	25.4	17.5
RD702	RD702SL	Socket/Female	1/4	1/4	1/4-18	NPTF	Brass	1	1.96	1.00	0.69	49.8	25.4	17.5
RD704	RD704SL	Socket/Female	1/4	3/8	3/8-18	NPTF	Brass	1	2.04	1.00	0.69	51.8	25.4	17.5
RD705L‡	RD705LSL	Socket/Female	1/4	9/16	9/16-18	UNF	Brass	1	1.96	1.00	0.69	49.8	25.4	17.5

Part Number Standard*	Acetylene Service	Coupling Type	Body Size	Port Size	Thread	Type	Material	Fig.	Dimensions			C	D	Hex
									C	D	Hex			
A2	—	Plug/Male	1/4	1/4	1/4-18	NPTF	Brass	2	1.46	0.77	0.69	37.1	19.6	17.5
A5L‡	—	Plug/Male	1/4	9/16	9/16-18	UNF	Brass	2	1.38	0.77	0.69	35.1	19.6	17.5

‡L.H. Thread—Inverted Flare
*Without sleeve lock

Um nome carregado de soluções

FLUID TRANSFER
AND HYDRAULIC

PNEUMATIC

SPECIAL APPLICATIONS

DIAGNOSTIC

AGRICULTURE

REFRIGERANT

700 Series

FLUID TRANSFER
AND HYDRAULIC

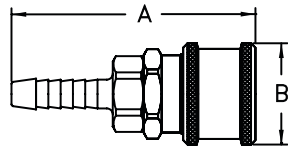

Figure 1

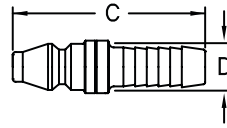
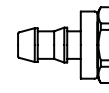
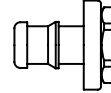

Figure 2



RD706P
Figure 1A



RD708P

Hose Stem End Connections

Part Number Standard*	Acetylene Service	Coupling Type	Body Size	Hose I.D.	Material	Fig.	Dimensions			
							A	B	A	B
							(in)	(in)	(mm)	(mm)
RD706	RD706SL	Socket/Female	1/4	1/4	Brass	1	2.48	1.00	63.0	25.4
RD706P§	—	Socket/Female	1/4	1/4	Brass	1	2.25	1.00	57.2	25.4
RD707	RD707SL	Socket/Female	1/4	5/16	Brass	1	2.48	1.00	63.0	25.4
RD708	RD708SL	Socket/Female	1/4	3/8	Brass	1	2.48	1.00	63.0	25.4
RD708P	—	Socket/Female	1/4	3/8	Brass	1	2.32	1.00	58.9	25.4

Part Number Standard*	Acetylene Service	Coupling Type	Body Size	Hose I.D.	Material	Fig.	Dimensions			
							C	D	C	D
							(in)	(in)	(mm)	(mm)
A7	—	Plug/Male	1/4	1/4	Brass	2	2.00	0.56	50.8	14.2
A8	—	Plug/Male	1/4	5/16	Brass	2	2.06	0.56	52.3	14.2
A9	—	Plug/Male	1/4	3/8	Brass	2	2.10	0.56	53.3	14.2

§For use with push-on style hose
*Without sleeve lock

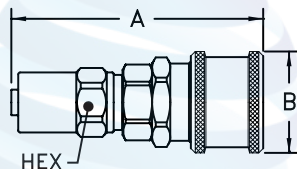

Figure 1

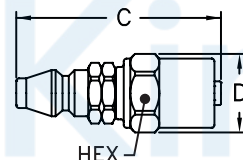

Figure 2

Hose Clamp End Connections

Part Number Standard*	Acetylene Service	Coupling Type	Body Size	Hose I.D.	Hose O.D.	Material	Fig.	Dimensions					
								A	B	Hex	A	B	Hex
								(in)	(in)	(in)	(mm)	(mm)	(mm)
RD70B3	RD70B3SL	Socket	1/4	1/4	1/2	Brass	1	2.57	1.00	0.63	65.3	25.4	16.0
RD70B7	—	Socket	1/4	1/4	5/8	Brass	1	2.57	1.00	0.75	65.3	25.4	19.1
RD70D7	—	Socket	1/4	3/8	5/8	Brass	1	2.69	1.00	0.75	68.3	25.4	19.1
RD70D9	—	Socket	1/4	3/8	11/16	Brass	1	2.69	1.00	0.81	68.3	25.4	20.6

Part Number Standard*	Acetylene Service	Coupling Type	Body Size	Hose I.D.	Hose O.D.	Material	Fig.	Dimensions					
								C	D	Hex	C	D	Hex
								(in)	(in)	(in)	(mm)	(mm)	(mm)
7B3	—	Plug	1/4	1/4	1/2	Brass	2	2.19	0.70	0.63	55.6	17.8	16.0
7B7	—	Plug	1/4	1/4	5/8	Brass	2	2.19	0.84	0.75	55.6	21.3	19.1

*Without sleeve lock

Dust Caps and Dust Plugs

Series	Dust Cap	Dust Plug
600	PPDC1HK	PSDC1HK
700	PPDC1HK	PSDC1HK



PNEUMATIC

SPECIAL APPLICATIONS

DIAGNOSTIC

AGRICULTURE

REFRIGERANT

2RL/3RL Series



Eaton's 2RL/3RL ring lock series quick disconnect pneumatic couplings have a unique interchange which Eaton designed for use with compressed air.

FLUID TRANSFER
AND HYDRAULIC

PNEUMATIC

SPECIAL APPLICATIONS

DIAGNOSTIC

AGRICULTURE

REFRIGERANT

Product Features

- High Flow capacity
- Push to connect with a ring lock sleeve
- Ring lock design prevents accidental disconnection
- To disconnect rotate sleeve 20 degrees
- Standard body material: Zinc trivalent plated steel
- Standard seal material: Buna-N
- Optional seal materials: Silicone-138, FKM-143, EPDM-192

Physical Characteristics

Series	Coupling Size (in)	Max. Operating Pressure		Min. Burst Pressure		Rated Flow	
		(bar)	(psi)	(bar)	(psi)	(lpm)	scfm
2RL	1/4	20	300	80	1,200	1,350	48
3RL	3/8	20	300	80	1,200	2,250	80

Applications & Markets

- Shipyards
- General Pneumatics
- Mining
- Marine

Flow Data

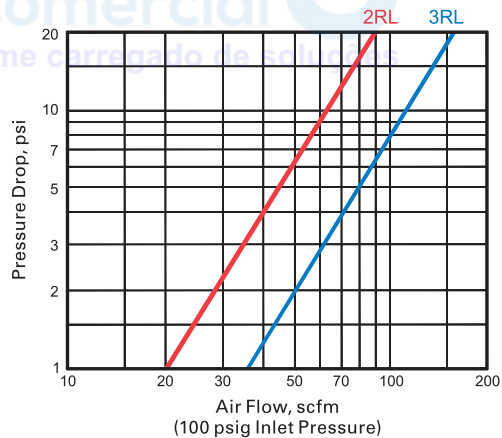

2RL Series

FLUID TRANSFER
AND HYDRAULIC

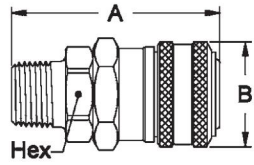

Figure 1

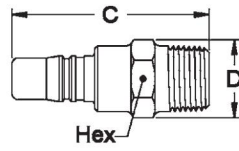

Figure 2

Male End Connections

Part Number	Coupling Type	Body Size	Port Size	Thread	Type	Fig.	Dimensions			A	B	Hex
							A	B	Hex			
							(in)	(in)	(in)	(mm)	(mm)	(mm)
2R10	Socket/Female	1/4	1/8	1/8-27	NPTF	1	2.01	1.06	0.88	51.1	26.9	22.4
2R15	Socket/Female	1/4	1/4	1/4-18	NPTF	1	2.16	1.06	0.88	54.9	26.9	22.4
2R20	Socket/Female	1/4	3/8	3/8-18	NPTF	1	2.16	1.06	0.88	54.9	26.9	22.4
2R25	Socket/Female	1/4	1/2	1/2-14	NPTF	1	2.35	1.06	0.88	59.7	26.9	22.4
Part Number	Coupling Type	Body Size	Port Size	Thread	Type	Fig.	Dimensions			C	D	Hex
							C	D	Hex			
							(in)	(in)	(in)	(mm)	(mm)	(mm)
2L10	Plug/Male	1/4	1/8	1/8-27	NPTF	2	1.51	0.58	0.50	38.4	14.7	12.7
2L15	Plug/Male	1/4	1/4	1/4-18	NPTF	2	1.66	0.65	0.56	42.2	16.5	14.2
2L15G†	Plug/Male	1/4	1/4	1/4-18	NPTF	2	2.64	0.77	0.69	67.1	19.6	17.5
2L20	Plug/Male	1/4	3/8	3/8-18	NPTF	2	2.04	0.79	0.69	51.8	20.1	17.5
2L20G†	Plug/Male	1/4	3/8	3/8-18	NPTF	2	2.64	0.77	0.69	67.1	19.6	17.5
2L25	Plug/Male	1/4	1/2	1/2-14	NPTF	2	2.31	1.01	0.88	58.7	25.7	22.4

†With Bleeder Ball Check—Reduces Hose Whip

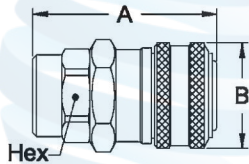

Figure 1

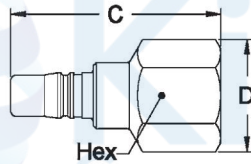

Figure 2

Female End Connections

Part Number	Coupling Type	Body Size	Port Size	Thread	Type	Fig.	Dimensions			A	B	Hex
							A	B	Hex			
							(in)	(in)	(in)	(mm)	(mm)	(mm)
2R11	Socket/Female	1/4	1/8	1/8-27	NPTF	1	1.91	1.06	0.88	48.5	26.9	22.4
2R16	Socket/Female	1/4	1/4	1/4-18	NPTF	1	1.91	1.06	0.88	48.5	26.9	22.4
2R21	Socket/Female	1/4	3/8	3/8-18	NPTF	1	2.16	1.06	0.88	54.9	26.9	22.4
2R26	Socket/Female	1/4	1/2	1/2-14	NPTF	1	2.43	1.06	1.00	61.7	26.9	25.4
Part Number	Coupling Type	Body Size	Port Size	Thread	Type	Fig.	Dimensions			C	D	Hex
							C	D	Hex			
							(in)	(in)	(in)	(mm)	(mm)	(mm)
2L11	Plug/Male	1/4	1/8	1/8-27	NPTF	2	1.36	0.65	0.56	34.5	16.5	14.2
2L16	Plug/Male	1/4	1/4	1/4-18	NPTF	2	1.54	0.79	0.69	39.1	20.1	17.5
2L16G†	Plug/Male	1/4	1/4	1/4-18	NPTF	2	2.55	0.77	0.69	64.8	19.6	17.5
2L21	Plug/Male	1/4	3/8	3/8-18	NPTF	2	1.88	0.94	0.81	47.8	23.9	20.6
2L26	Plug/Male	1/4	1/2	1/2-14	NPTF	2	2.18	1.15	1.00	55.4	29.2	25.4

†With Bleeder Ball Check—Reduces Hose Whip

PNEUMATIC

SPECIAL APPLICATIONS

DIAGNOSTIC

AGRICULTURE

REFRIGERANT

2RL Series

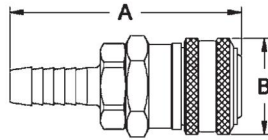

Figure 1

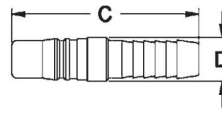

Figure 2

Hose Stem End Connections

Part Number	Coupling Type	Body Size	Hose I.D.	Fig.	Dimensions		A	B
					A	B		
					(in)	(in)	(mm)	(mm)
2R17	Socket/Female	1/4	1/4	1	2.63	1.06	66.8	26.9
2R195	Socket/Female	1/4	5/16	1	2.63	1.06	66.8	26.9
2R22	Socket/Female	1/4	3/8	1	2.63	1.06	66.8	26.9
2R27	Socket/Female	1/4	1/2	1	2.63	1.06	66.8	26.9

Part Number	Coupling Type	Body Size	Hose I.D.	Fig.	Dimensions		C	D
					C	D		
					(in)	(in)	(mm)	(mm)
2L17	Plug/Male	1/4	1/4	2	2.13	0.50	54.1	12.7
2L195	Plug/Male	1/4	5/16	2	2.13	0.50	54.1	12.7
2L22	Plug/Male	1/4	3/8	2	2.13	0.50	54.1	12.7
2L27	Plug/Male	1/4	1/2	2	2.5	0.81	63.5	20.6

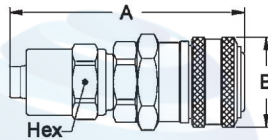

Figure 1

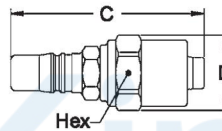

Figure 2

Hose Clamp End Connections

Part Number	Coupling Type	Body Size	Hose I.D.	Hose O.D.	Fig.	Dimensions			A	B	Hex
						A	B	Hex			
						(in)	(in)	(in)	(mm)	(mm)	(mm)
2R18B1	Socket/Female	1/4	1/4	15/32	1	2.73	1.06	0.63	69.3	26.9	16.00
2R18B3	Socket/Female	1/4	1/4	1/2	1	2.73	1.06	0.63	69.3	26.9	16.00
2R18B7	Socket/Female	1/4	1/4	5/8	1	2.73	1.06	0.75	69.3	26.9	19.05
2R18B11	Socket/Female	1/4	1/4	3/4	1	2.73	1.06	0.88	69.3	26.9	22.35
2R185C7	Socket/Female	1/4	5/16	5/8	1	2.79	1.06	0.75	70.9	26.9	19.05
2R185C9	Socket/Female	1/4	5/16	11/16	1	2.79	1.06	0.81	70.9	26.9	20.57
2R23D7	Socket/Female	1/4	3/8	5/8	1	2.85	1.06	0.75	72.4	26.9	19.05
2R23D9	Socket/Female	1/4	3/8	11/16	1	2.85	1.06	0.81	72.4	26.9	20.57
2R23D11	Socket/Female	1/4	3/8	3/4	1	2.85	1.06	0.88	72.4	26.9	22.35
2R23D13	Socket/Female	1/4	3/8	13/16	1	2.85	1.06	0.94	72.4	26.9	23.88
2R28P13	Socket/Female	1/4	1/2	13/16	1	3.48	1.06	0.94	88.4	26.9	23.88
2R28P15	Socket/Female	1/4	1/2	7/8	1	3.48	1.06	1.00	88.4	26.9	25.40

Part Number	Coupling Type	Body Size	Hose I.D.	Hose O.D.	Fig.	Dimensions			C	D	Hex
						C	D	Hex			
						(in)	(in)	(in)	(mm)	(mm)	(mm)
2L18B3	Plug/Male	1/4	1/4	1/2	2	2.23	0.70	0.63	56.6	17.8	16.00
2L185C7	Plug/Male	1/4	5/16	5/8	2	2.29	0.84	0.75	58.2	21.3	19.05
2L185C9	Plug/Male	1/4	5/16	11/16	2	2.29	0.91	0.81	58.2	23.1	20.57
2L23D5	Plug/Male	1/4	3/8	9/16	2	2.35	0.77	0.69	59.7	19.6	17.53
2L23D7	Plug/Male	1/4	3/8	5/8	2	2.35	0.84	0.75	59.7	21.3	19.05
2L23D9	Plug/Male	1/4	3/8	11/16	2	2.35	0.91	0.81	59.7	23.1	20.57
2L23D11	Plug/Male	1/4	3/8	3/4	2	2.35	0.98	0.88	59.7	24.9	22.35
2L23D13	Plug/Male	1/4	3/8	13/16	2	2.35	1.05	0.94	59.7	26.7	23.88
2L28P13	Plug/Male	1/4	1/2	13/16	2	3.41	1.05	0.94	86.6	26.7	23.88
2L28P15	Plug/Male	1/4	1/2	7/8	2	3.41	1.12	1.00	86.6	28.4	25.40

FLUID TRANSFER AND HYDRAULIC

PNEUMATIC

SPECIAL APPLICATIONS

DIAGNOSTIC

AGRICULTURE

REFRIGERANT

3RL Series

FLUID TRANSFER
AND HYDRAULIC

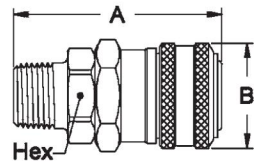

Figure 1

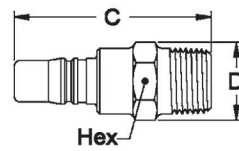

Figure 2

Male End Connections

Part Number	Coupling Type	Body Size	Port Size	Thread	Type	Fig.	Dimensions			Hex	A	B	Hex
							A	B	Hex				
							(in)	(in)	(in)	(mm)	(mm)	(mm)	
3R15	Socket/Female	3/8	1/4	1/4-18	NPTF	1	2.34	1.31	1.00	59.4	33.3	25.4	
3R20	Socket/Female	3/8	3/8	3/8-18	NPTF	1	2.35	1.31	1.00	59.7	33.3	25.4	
3R25	Socket/Female	3/8	1/2	1/2-14	NPTF	1	2.54	1.31	1.00	64.5	33.3	25.4	
3R30	Socket/Female	3/8	3/4	3/4-14	NPTF	1	2.54	1.31	1.06	64.5	33.3	26.9	

Part Number	Coupling Type	Body Size	Port Size	Thread	Type	Fig.	Dimensions			Hex	C	D	Hex
							C	D	Hex				
							(in)	(in)	(in)	(mm)	(mm)	(mm)	
3L10	Plug/Male	3/8	1/8	1/8-27	NPTF	2	1.54	0.72	0.63	39.1	18.3	16.0	
3L15	Plug/Male	3/8	1/4	1/4-18	NPTF	2	1.70	0.72	0.63	43.2	18.3	16.0	
3L15G†	Plug/Male	3/8	1/4	1/4-18	NPTF	2	2.64	0.98	0.88	67.1	24.9	22.4	
3L20	Plug/Male	3/8	3/8	3/8-18	NPTF	2	1.76	0.79	0.69	44.7	20.1	17.5	
3L20G†	Plug/Male	3/8	3/8	3/8-18	NPTF	2	2.64	0.98	0.88	67.1	24.9	22.4	
3L25	Plug/Male	3/8	1/2	1/2-14	NPTF	2	2.31	1.01	0.88	58.7	25.7	22.4	
3L25G†	Plug/Male	3/8	1/2	1/2-14	NPTF	2	2.83	0.98	0.88	71.9	24.9	22.4	
3L30	Plug/Male	3/8	3/4	3/4-14	NPTF	2	2.38	1.23	1.06	60.5	31.2	26.9	
3L30G†	Plug/Male	3/8	3/4	3/4-14	NPTF	2	2.88	1.19	1.06	73.2	30.2	26.9	

†With Bleeder Ball Check—Reduces Hose Whip

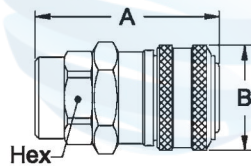

Figure 1

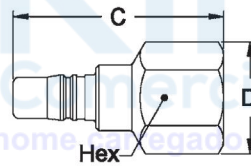

Figure 2

Female End Connections

Part Number	Coupling Type	Body Size	Port Size	Thread	Type	Fig.	Dimensions			Hex	A	B	Hex
							A	B	Hex				
							(in)	(in)	(in)	(mm)	(mm)	(mm)	
3R16	Socket/Female	3/8	1/4	1/4-18	NPTF	1	2.29	1.31	1.00	58.2	33.3	25.4	
3R21	Socket/Female	3/8	3/8	3/8-18	NPTF	1	2.35	1.31	1.00	59.7	33.3	25.4	
3R26	Socket/Female	3/8	1/2	1/2-14	NPTF	1	2.63	1.31	1.00	66.8	33.3	25.4	
3R31A	Socket/Female	3/8	3/4	3/4-14	NPTF	1	2.66	1.31	1.19	67.6	33.3	30.2	

Part Number	Coupling Type	Body Size	Port Size	Thread	Type	Fig.	Dimensions			Hex	C	D	Hex
							C	D	Hex				
							(in)	(in)	(in)	(mm)	(mm)	(mm)	
3L16	Plug/Male	3/8	1/4	1/4-18	NPTF	2	1.48	0.79	0.69	37.6	20.1	17.5	
3L16G†	Plug/Male	3/8	1/4	1/4-18	NPTF	2	2.39	0.98	0.88	60.7	24.9	22.4	
3L21	Plug/Male	3/8	3/8	3/8-18	NPTF	2	1.63	0.94	0.81	41.4	23.9	20.6	
3L26	Plug/Male	3/8	1/2	1/2-14	NPTF	2	2.25	1.15	1.00	57.2	29.2	25.4	
3L26G†	Plug/Male	3/8	1/2	1/2-14	NPTF	2	2.91	0.98	1.00	73.9	24.9	25.4	
3L31	Plug/Male	3/8	3/4	3/4-14	NPTF	2	2.25	1.37	1.19	57.2	34.8	30.2	

†With Bleeder Ball Check—Reduces Hose Whip

PNEUMATIC

SPECIAL APPLICATIONS

DIAGNOSTIC

AGRICULTURE

REFRIGERANT

3RL Series

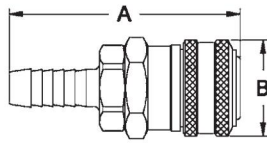

Figure 1

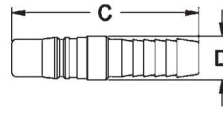

Figure 2

Hose Stem End Connections

Part Number	Coupling Type	Body Size	Hose I.D.	Fig.	Dimensions			
					A (in)	B (in)	A (mm)	B (mm)
3R17	Socket/Female	3/8	1/4	1	2.85	1.31	72.4	33.3
3R195	Socket/Female	3/8	5/16	1	2.85	1.31	72.4	33.3
3R22	Socket/Female	3/8	3/8	1	2.89	1.31	73.4	33.3
3R27	Socket/Female	3/8	1/2	1	2.81	1.31	71.4	33.3
3R32	Socket/Female	3/8	3/4	1	3.66	1.31	93.0	33.3

Part Number	Coupling Type	Body Size	Hose I.D.	Fig.	Dimensions			
					C (in)	D (in)	C (mm)	D (mm)
3L17	Plug/Male	3/8	1/4	2	2.16	0.63	54.9	16.0
3L17G†	Plug/Male	3/8	1/4	2	3.11	0.98	79.0	24.9
3L195	Plug/Male	3/8	5/16	2	2.16	0.63	54.9	16.0
3L195G†	Plug/Male	3/8	5/16	2	3.11	0.98	79.0	24.9
3L22	Plug/Male	3/8	3/8	2	2.16	0.75	54.9	19.1
3L22G†	Plug/Male	3/8	3/8	2	3.11	0.98	79.0	24.9
3L27	Plug/Male	3/8	1/2	2	2.16	0.81	54.9	20.6
3L27G†	Plug/Male	3/8	1/2	2	3.11	0.98	79.0	24.9
3L32	Plug/Male	3/8	3/4	2	3.13	1.00	79.5	25.4
3L32G†	Plug/Male	3/8	3/4	2	3.96	0.98	100.6	24.9

†With Bleeder Ball Check—Reduces Hose Whip

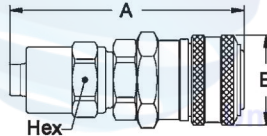

Figure 1

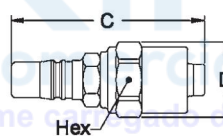

Figure 2

Hose Clamp End Connections

Part Number	Coupling Type	Body Size	Hose I.D.	Hose O.D.	Fig.	Dimensions					
						A (in)	B (in)	Hex (in)	A (mm)	B (mm)	Hex (mm)
3R23D7	Socket/Female	3/8	3/8	5/8	1	3.06	1.31	0.75	77.7	33.3	19.05
3R23D9	Socket/Female	3/8	3/8	11/16	1	3.06	1.31	0.81	77.7	33.3	20.57
3R23D11	Socket/Female	3/8	3/8	3/4	1	3.06	1.31	0.88	77.7	33.3	22.35
3R28P13	Socket/Female	3/8	1/2	13/16	1	3.66	1.31	0.94	93.0	33.3	23.88
3R28P15	Socket/Female	3/8	1/2	7/8	1	3.66	1.31	1.00	93.0	33.3	25.40
3R28P17	Socket/Female	3/8	1/2	15/16	1	3.66	1.31	1.06	93.0	33.3	26.92
3R33R23	Socket/Female	3/8	3/4	1 1/8	1	3.79	1.31	1.25	96.3	33.3	31.75
3R33R25	Socket/Female	3/8	3/4	1 3/16	1	3.79	1.31	1.31	96.3	33.3	33.27

Part Number	Coupling Type	Body Size	Hose I.D.	Hose O.D.	Fig.	Dimensions					
						C (in)	D (in)	Hex (in)	C (mm)	D (mm)	Hex (mm)
3L23D7	Plug/Male	3/8	3/8	5/8	2	2.45	0.84	0.75	62.2	21.3	19.05
3L23D9	Plug/Male	3/8	3/8	11/16	2	2.45	0.91	0.81	62.2	23.1	20.57
3L23D11	Plug/Male	3/8	3/8	3/4	2	2.45	0.98	0.88	62.2	24.9	22.35
3L28P13	Plug/Male	3/8	1/2	13/16	2	3.14	1.05	0.94	79.8	26.7	23.88
3L28P15	Plug/Male	3/8	1/2	7/8	2	3.14	1.12	1.00	79.8	28.4	25.40
3L33R23	Plug/Male	3/8	3/4	1 1/8	2	3.56	1.40	1.25	90.4	35.6	31.75
3L33R25	Plug/Male	3/8	3/4	1 3/16	2	3.56	1.47	1.31	90.4	37.3	33.27

Dust Caps and Dust Plugs

Series	Dust Cap	Dust Plug
2RL	PPDC1HK	PSDC1HK
3RL	PPDC2HK	PSDC2HK



Full-Bore Series



Eaton's Full-Bore Series is a premium automatic one-way shutoff quick disconnect coupling. Two sleeves must be actuated in sequence to bleed off back pressure and release the connector, preventing accidental uncoupling.

Product Features

- Pressure relieving feature fully vents downstream air, making connection/disconnection fast and easy, and eliminating hose whip
- Unique straight through design eliminates restrictive springs and poppet valves, allowing unimpeded air flow
- Two sleeve activation prevents accidental disconnect
- Standard body material: Zinc trivalent plated carbon steel
- Standard seal material: Buna-N

Physical Characteristics

Body Size		Max. Operating Pressure		Min. Burst Pressure		Rated Flow	
(in)	(bar)	(psi)	(bar)	(psi)	(lpm)	scfm	
3/8	15	250	60	1,000	1,784	63	
1/2	15	250	60	1,000	2,860	101	

Applications & Markets

- Construction
- Maintenance and Repair
- In-Plant/Industrial
- Railyards
- General Pneumatics

Flow Data

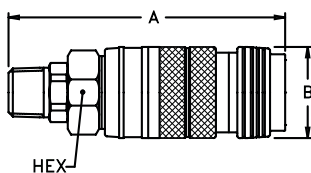
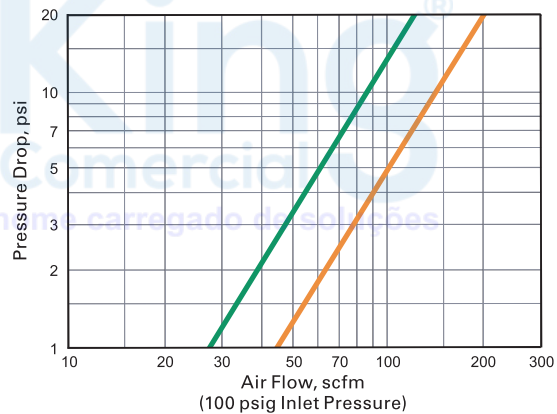

Figure 1

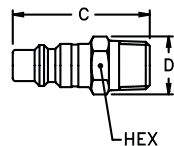

Figure 2

Male End Connections

Part Number	Coupling Type	Body Size	Port Size	Thread	Type	Fig.	Dimensions			A	B	Hex
							A	B	Hex			
23203013	Socket/Female	3/8	3/8	3/8-18	NPTF	1	(in)	(in)	(in)	(mm)	(mm)	(mm)
23203014	Socket/Female	3/8	1/2	1/2-14	NPTF	1	4.10	1.25	1.00	71.1	31.8	25.4
23204014	Socket/Female	1/2	1/2	1/2-14	NPTF	1	4.43	1.38	1.13	112.5	35.1	28.7
23204015	Socket/Female	1/2	3/4	3/4-14	NPTF	1	4.67	1.38	1.13	118.6	35.1	28.7

Part Number	Coupling Type	Body Size	Port Size	Thread	Type	Fig.	Dimensions			C	D	Hex
							C	D	Hex			
40	Plug/Male	3/8	1/4	1/4-18	NPTF	2	(in)	(in)	(in)	(mm)	(mm)	(mm)
42	Plug/Male	3/8	3/8	3/8-18	NPTF	2	1.88	0.72	0.63	47.8	18.3	16.0
44	Plug/Male	3/8	1/2	1/2-14	NPTF	2	2.09	1.01	0.69	47.8	20.1	17.5
52	Plug/Male	1/2	3/8	3/8-18	NPTF	2	2.25	0.87	0.75	57.2	22.1	19.1
54E	Plug/Male	1/2	1/2	1/2-14	NPTF	2	2.44	1.01	0.88	62.0	25.7	22.4
56	Plug/Male	1/2	3/4	3/4-14	NPTF	2	2.50	1.23	1.06	63.5	31.2	26.9

Full-Bore Series

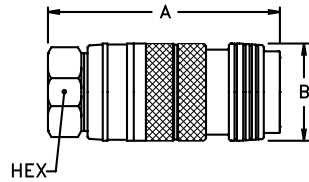

Figure 1

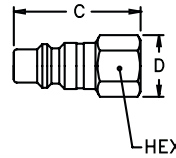

Figure 2

Female End Connections

Part Number	Coupling Type	Body Size	Port Size	Thread	Type	Fig.	Dimensions			A	B	Hex
							A	B	Hex			
							(in)	(in)	(in)	(mm)	(mm)	(mm)
23203300	Socket/Female	3/8	3/8	3/8-18	NPTF	1	3.17	1.25	1.00	80.5	31.8	25.4
23203004	Socket/Female	3/8	1/2	1/2-14	NPTF	1	3.92	1.25	1.00	99.6	31.8	25.4
23204400	Socket/Female	1/2	1/2	1/2-14	NPTF	1	3.31	1.38	1.13	84.1	35.1	28.7
23204005	Socket/Female	1/2	3/4	3/4-14	NPTF	1	4.30	1.38	1.13	109.2	35.1	28.7

Part Number	Coupling Type	Body Size	Port Size	Thread	Type	Fig.	Dimensions			C	D	Hex
							C	D	Hex			
							(in)	(in)	(in)	(mm)	(mm)	(mm)
41	Plug/Male	3/8	1/4	1/4-18	NPTF	2	1.63	0.79	0.69	41.4	20.1	17.5
43	Plug/Male	3/8	3/8	3/8-18	NPTF	2	1.81	0.94	0.81	46.0	23.9	20.6
45E	Plug/Male	3/8	1/2	1/2-14	NPTF	2	2.06	1.15	1.00	52.3	29.2	25.4
53	Plug/Male	1/2	3/8	3/8-18	NPTF	2	2.06	0.94	0.81	52.3	23.9	20.6
55	Plug/Male	1/2	1/2	1/2-14	NPTF	2	2.34	1.15	1.00	59.4	29.2	25.4
57	Plug/Male	1/2	3/4	3/4-14	NPTF	2	2.44	1.37	1.19	62.0	34.8	30.2

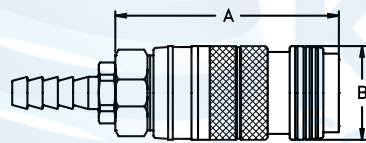

Figure 1

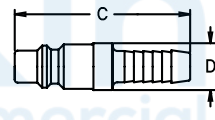

Figure 2

Hose Stem End Connections

Part Number	Coupling Type	Body Size	Hose I.D.	Fig.	Dimensions			
					A	B	A	B
					(in)	(in)	(mm)	(mm)
23203024	Socket/Female	3/8	1/4	1	4.36	1.25	110.7	31.8
23203025	Socket/Female	3/8	3/8	1	4.48	1.25	113.8	31.8
23204025	Socket/Female	1/2	1/2	1	4.80	1.38	121.9	35.1
23204026	Socket/Female	1/2	3/4	1	4.80	1.38	121.9	35.1

Part Number	Coupling Type	Body Size	Hose I.D.	Fig.	Dimensions			
					C	D	C	D
					(in)	(in)	(mm)	(mm)
404	Plug/Male	3/8	1/4	2	2.34	0.63	59.4	16.0
406	Plug/Male	3/8	3/8	2	2.34	0.63	59.4	16.0
408	Plug/Male	3/8	1/2	2	2.34	0.81	59.4	20.6
59	Plug/Male	1/2	3/8	2	2.66	0.69	67.6	17.5
60	Plug/Male	1/2	1/2	2	2.66	0.75	67.6	19.1
61E	Plug/Male	1/2	3/4	2	3.50	1.00	88.9	25.4

FLUID TRANSFER AND HYDRAULIC

PNEUMATIC

SPECIAL APPLICATIONS

DIAGNOSTIC

AGRICULTURE

REFRIGERANT

210/310 Series



Eaton's 210/310 series pneumatic couplings have a pin-type one-way shut off operation.

Product Features

- Automatic push-to-connect
- Pin-lock design
- Alloy steel locking pins
- Standard body material: Zinc trivalent plated carbon steel
- Standard seal material: Buna-N

Physical Characteristics

Series	Body Size	Max. Operating Pressure		Min. Burst Pressure		Rated Flow	
	(in)	(bar)	(psi)	(bar)	(psi)	(lpm)	scfm
210	1/4	17	250	68	1,000	538	19
310	3/8	17	250	68	1,000	1,415	50

Applications & Markets

- Construction
- Maintenance and Repair
- In-plant/Industrial
- Pneumatic Tools

Flow Data

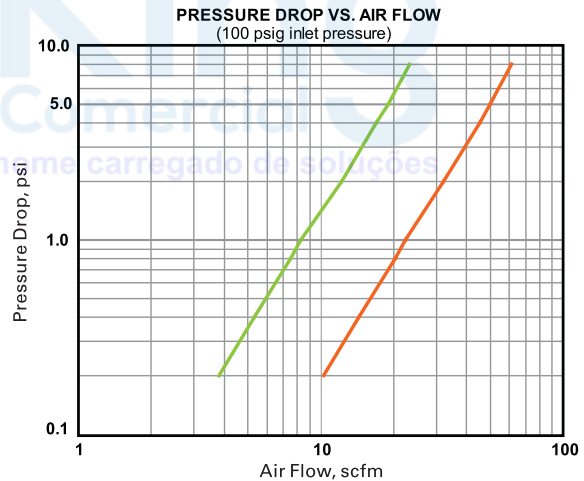

210 Series

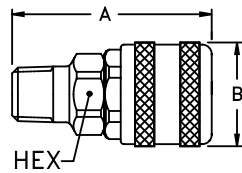

Figure 1

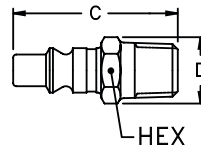

Figure 2

Male End Connections

Part Number	Coupling Type	Body Size	Port Size	Thread	Type	Fig.	Dimensions			A	B	Hex
							A	B	Hex			
							(in)	(in)	(in)	(mm)	(mm)	(mm)
210212	Socket/Female	1/4	1/4	1/4-18	NPTF	1	1.95	1.02	0.69	49.5	25.9	17.5
210213	Socket/Female	1/4	3/8	3/8-18	NPTF	1	1.91	1.02	0.69	48.5	25.9	17.5

Part Number	Coupling Type	Body Size	Port Size	Thread	Type	Fig.	Dimensions			C	D	Hex
							C	D	Hex			
							(in)	(in)	(in)	(mm)	(mm)	(mm)
2607	Plug/Male	1/4	1/8	1/8-27	NPTF	2	1.42	0.58	0.5	36.1	14.7	12.7
2608	Plug/Male	1/4	1/4	1/4-18	NPTF	2	1.68	0.65	0.56	42.7	16.5	14.2
2608B	Plug/Male	1/4	1/4	1/4-19	BSPT	2	1.68	0.65	0.56	42.7	16.5	14.2
20AP37M	Plug/Male	1/4	3/8	3/8-18	NPTF	2	1.68	0.79	0.69	42.7	20.1	17.5

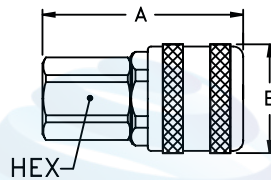

Figure 1

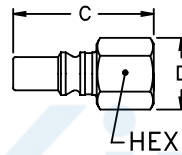

Figure 2

Female End Connections

Part Number	Coupling Type	Body Size	Port Size	Thread	Type	Fig.	Dimensions			A	B	Hex
							A	B	Hex			
							(in)	(in)	(in)	(mm)	(mm)	(mm)
210	Socket/Female	1/4	1/4	1/4-18	NPTF	1	1.87	1.02	0.69	47.5	25.9	17.5
62210*	Socket/Female	1/4	1/4	1/4-18	NPTF	1	1.87	1.02	0.69	47.5	25.9	17.5
210B	Socket/Female	1/4	1/4	1/4-19	BSPP	1	1.64	1.02	0.75	41.7	25.9	19.1

Part Number	Coupling Type	Body Size	Port Size	Thread	Type	Fig.	Dimensions			C	D	Hex
							C	D	Hex			
							(in)	(in)	(in)	(mm)	(mm)	(mm)
2609	Plug/Male	1/4	1/4	1/4-18	NPTF	2	1.55	0.79	0.69	39.4	20.1	17.5
2609B	Plug/Male	1/4	1/4	1/4-19	BSPP	2	1.52	0.79	0.69	38.6	20.1	17.5
20AP37F	Plug/Male	1/4	3/8	3/8-18	NPTF	2	1.61	0.94	0.81	40.9	23.9	20.6

*Same as Model 210 but with brass valve.

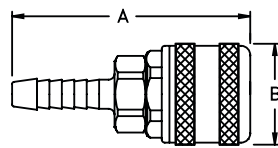

Figure 1

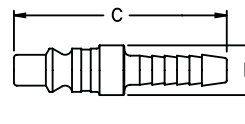

Figure 2

Hose Stem End Connections

Part Number	Coupling Type	Body Size	Hose I.D.	Fig.	Dimensions		A	B
					A	B		
					(in)	(in)	(mm)	(mm)
210022	Socket/Female	1/4	1/4	1	2.39	1.02	60.7	25.9
210215	Socket/Female	1/4	3/8	1	2.39	1.02	60.7	25.9

Part Number	Coupling Type	Body Size	Hose I.D.	Fig.	Dimensions		C	D
					C	D		
					(in)	(in)	(mm)	(mm)
3946	Plug/Male	1/4	1/4	2	2.14	0.47	54.4	11.9
3947	Plug/Male	1/4	5/16	2	2.14	0.47	54.4	11.9
22238E	Plug/Male	1/4	3/8	2	2.14	0.5	54.4	12.7

FLUID TRANSFER AND HYDRAULIC

PNEUMATIC

SPECIAL APPLICATIONS

DIAGNOSTIC

AGRICULTURE

REFRIGERANT

310 Series

FLUID TRANSFER
AND HYDRAULIC

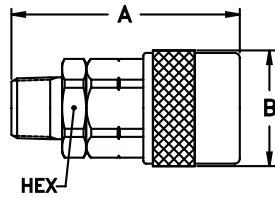

Figure 1

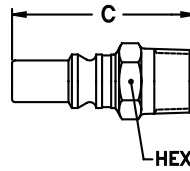

Figure 2

Male End Connections

Part Number	Coupling Type	Body Size	Port Size	Thread	Type	Fig.	Dimensions			Hex	A	B	Hex
							A	B	Hex				
310313	Socket/Female	3/8	3/8	3/8-18	NPTF	1	2.37	1.21	0.94	60.2	30.7	23.9	

Part Number	Coupling Type	Body Size	Port Size	Thread	Type	Fig.	Dimensions			Hex	C	D	Hex
							C	D	Hex				
22239E	Plug/Male	3/8	1/4	1/4-18	NPTF	2	1.91	0.72	0.63	48.5	18.3	16.0	
3804	Plug/Male	3/8	3/8	3/8-18	NPTF	2	1.91	0.79	0.69	48.5	20.1	17.5	

PNEUMATIC

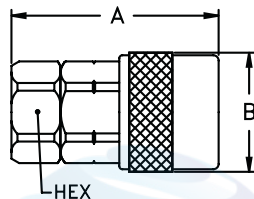

Figure 1

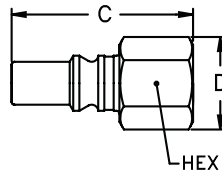

Figure 2

Female End Connections

Part Number	Coupling Type	Body Size	Port Size	Thread	Type	Fig.	Dimensions			Hex	A	B	Hex
							A	B	Hex				
310	Socket/Female	3/8	3/8	3/8-18	NPTF	1	2.1	1.21	0.94	53.3	30.7	23.9	

Part Number	Coupling Type	Body Size	Port Size	Thread	Type	Fig.	Dimensions			Hex	C	D	Hex
							C	D	Hex				
3806	Plug/Male	3/8	3/8	3/8-18	NPTF	2	1.84	0.94	0.81	46.7	23.9	20.6	

SPECIAL APPLICATIONS

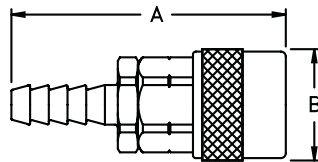

Figure 1

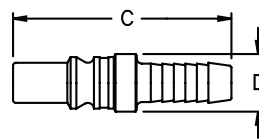

Figure 2

Hose Stem End Connections

Part Number	Coupling Type	Body Size	Hose I.D.	Fig.	Dimensions		A	B
					A	B		
310222	Socket/Female	3/8	3/8	1	2.97	1.21	75.4	30.7

Part Number	Coupling Type	Body Size	Hose I.D.	Fig.	Dimensions		C	D
					C	D		
3807	Plug/Male	3/8	3/8	2	2.37	0.59	60.2	15.0

DIAGNOSTIC

AGRICULTURE

REFRIGERANT

FD14 Series Oil Drain Coupling



Eaton's FD14 Drain Coupling is designed to serve as a drain port for use with Eaton's FLOCS (Fast Lube Oil Change System) as well as providing a purging port for use during pre-fill operations. The FD14 provides a leak free push to connect operation for improving speed and efficiency for oil evacuation systems.

Product Features

- Low-Profile design with multiple sealing mechanisms
- Push-To-Connect socket/female half for easy one-hand operation
- Broad range of standard thread styles for plug/male half
- Utilizes a Copper-Crush gasket to seat against the port face
- Standard plug/male half seal material: FKM
- Standard socket/female half seal material: Buna-N
- Standard body material: High resistance carbon steel with zinc trivalent plating with zinc die-cast valve

Physical Characteristics

Body Size (in)	Max. Operating Pressure		Min. Burst Pressure Connected		Vacuum Connected Only	Rated Flow	
	(bar)	(psi)	(bar)	(psi)	(in./Hg)	(lpm)	(gpm)
3/8	3.5	50	7.0	200	28	12	3

Applications & Markets

- Automated oil evacuation systems
- Gravity drain oil evacuation systems

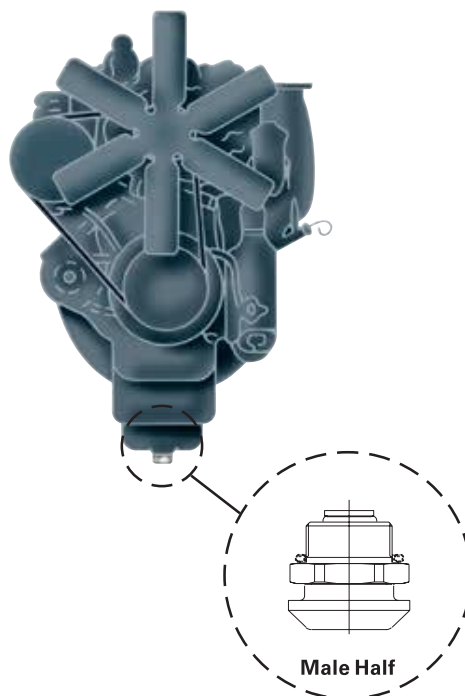

FD14 Series Oil Drain Coupling

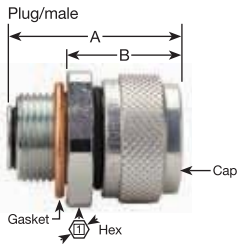

Figure 1

Dimensions (English Thread)

Body Size	Thread Size	Fig.	Dimensions		Hex		Min. Assy. Torque	Part Number Assembly (includes Gasket & Cap)	Gasket (Copper-Crush)	Cap (Brass)			
			A	B									
P													
			mm	(in)	mm	(in)	mm	(in)	N-m	(lbs-ft)			
3/8	1 1/16-12 UN-2A	1	39.1	(1.54)	24.4	(.96)	38.1	(1 1/2)	41-81	(30-60)*	FD14-4002-20-06	FD14-1206-08	FD14-1210-06
3/8	1 1/4-18 UNEF-2A	1	39.1	(1.54)	24.4	(.96)	38.1	(1 1/2)	41-81	(30-60)*	FD14-4002-05-06	FD14-1206-11	FD14-1210-06
3/8	1 1/8-12 UNF-2A	1	39.1	(1.54)	24.4	(.96)	38.1	(1 1/2)	41-81	(30-60)*	FD14-4002-14-06	FD14-1206-09	FD14-1210-06
3/8	1/2-14 DRYSEAL NPTF	1	40.6	(1.60)	24.4	(.96)	27.0	(1 1/16)	-	-	FD14-4002-27-06*	None Needed	FD14-1210-06
3/8	1/2-14 UNS-2A	1	38.6	(1.52)	24.4	(.96)	27.0	(1 1/16)	27-33	(20-24)*	FD14-4002-22-06*	FD14-1206-01	FD14-1210-06
3/8	1/2-20 UNF-2A	1	38.6	(1.52)	24.4	(.96)	27.0	(1 1/16)	27-33	(20-24)*	FD14-4002-01-06*	FD14-1206-01	FD14-1210-06
3/8	1-18 UNS-2A	1	39.1	(1.54)	24.4	(.96)	31.8	(1 1/4)	41-81	(30-60)*	FD14-4002-06-06	FD14-1206-07	FD14-1210-06
3/8	3/4-14 DRYSEAL NPTF	1	43.8	(1.72)	24.4	(.96)	31.8	(1 1/4)	-	-	FD14-4002-26-06	None Needed	FD14-1210-06
3/8	3/4-16 UNF-2A	1	39.1	(1.54)	24.4	(.96)	31.8	(1 1/4)	41-68	(30-50)*	FD14-4002-09-06	FD14-1206-04	FD14-1210-06
3/8	5/8-18 UNF-2A	1	38.6	(1.52)	24.4	(.96)	27.0	(1 1/16)	27-54	(20-40)*	FD14-4002-08-06*	FD14-1206-03	FD14-1210-06
3/8	7/8-14 UNF-2A	1	39.1	(1.54)	24.4	(.96)	31.8	(1 1/4)	41-81	(30-60)*	FD14-4002-10-06	FD14-1206-06	FD14-1210-06
3/8	7/8-18 UNS-2A	1	39.1	(1.54)	24.4	(.96)	31.8	(1 1/4)	41-81	(30-60)*	FD14-4002-07-06	FD14-1206-06	FD14-1210-06
3/8	9/16-18 UNF-2A	1	38.6	(1.52)	24.4	(.96)	27.0	(1 1/16)	27-54	(20-40)*	FD14-4002-12-06*	FD14-1206-02	FD14-1210-06

*CAUTION: Failure to meet minimum assembly torque could result in fluid leakage.

Dimensions (English Thread)

Body Size	Thread Size	Fig.	Dimensions		Hex		Min. Assy. Torque	Part Number Assembly (includes Gasket & Cap)	Gasket (Copper-Crush)	Cap (Brass)			
			A	B									
P													
			mm	(in)	mm	(in)	mm	(in)	N-m	(lbs-ft)			
3/8	M12 X 1.5 6g	1	38.6	(1.52)	24.4	(.96)	27.0	(1 1/16)	27-33	(20-24)*	FD14-4002-23-06*	FD14-1206-01	FD14-1210-06
3/8	M12 X 1.75 6g	1	38.6	(1.52)	24.4	(.96)	27.0	(1 1/16)	27-33	(20-24)*	FD14-4002-25-06*	FD14-1206-01	FD14-1210-06
3/8	M14 X 1.25 6g	1	38.6	(1.52)	24.4	(.96)	27.0	(1 1/16)	27-33	(20-24)*	FD14-4002-03-06*	FD14-1206-02	FD14-1210-06
3/8	M14 X 1.5 6g	1	38.6	(1.52)	24.4	(.96)	27.0	(1 1/16)	27-33	(20-24)*	FD14-4002-24-06*	FD14-1206-02	FD14-1210-06
3/8	M18 X 1.5 6g	1	38.6	(1.52)	24.4	(.96)	31.8	(1 1/4)	27-33	(20-24)*	FD14-4002-02-06*	FD14-1206-04	FD14-1210-06
3/8	M20 X 1.5 6g	1	39.1	(1.54)	24.4	(.96)	31.8	(1 1/4)	41-81	(30-60)*	FD14-4002-16-06	FD14-1206-05	FD14-1210-06
3/8	M22 X 1.5 6g	1	39.1	(1.54)	24.4	(.96)	31.8	(1 1/4)	41-81	(30-60)*	FD14-4002-18-06	FD14-1206-06	FD14-1210-06
3/8	M24 X 1.5 6g	1	39.1	(1.54)	24.4	(.96)	31.8	(1 1/4)	41-81	(30-60)*	FD14-4002-19-06	FD14-1206-07	FD14-1210-06
3/8	M24 X 2 6g	1	39.1	(1.54)	24.4	(.96)	31.8	(1 1/4)	41-81	(30-60)*	FD14-4002-11-06	FD14-1206-07	FD14-1210-06
3/8	M25 X 1.5 6g	1	39.1	(1.54)	24.4	(.96)	31.8	(1 1/4)	41-81	(30-60)*	FD14-4002-17-06	FD14-1206-07	FD14-1210-06
3/8	M27 X 2 6g	1	36.3	(1.43)	24.4	(.96)	38.1	(1 1/2)	41-81	(30-60)*	FD14-4002-29-06	FD14-1206-06	FD14-1210-06
3/8	M30 X 1.5 6g	1	39.1	(1.54)	24.4	(.96)	38.1	(1 1/2)	41-81	(30-60)*	FD14-4002-21-06	FD14-1206-10	FD14-1210-06

*CAUTION: Failure to meet minimum assembly torque could result in fluid leakage.

Dimensions (Socket/Female Half NPTF, Valved)

Body Size	Thread Size	Fig.	Dimensions		Hex	Part Number Assembly			
			A	B					
P									
			mm	(in)	mm	(in)			
3/8	3/4-14 Dryseal NPTF	2	46.5	(1.83)	45.7	(1.80)	33.0	(1 5/16)	FD14-1001-12-06

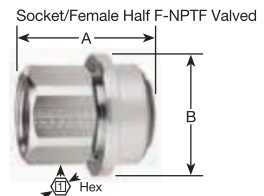

Figure 2

Dimensions (Socket/Female Half Assembly, Non-Valved)

Body Size	Hose Size	Fig.	Dimensions		Part Number Assembly		
			A	B			
P							
			mm	(in)	mm	(in)	
3/8	5/8" SOCKETLESS™	3	59.4	(2.34)	38.1	(1.50)	FD14-4003-10-06

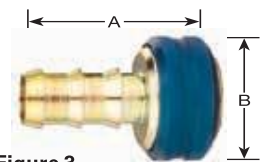

Figure 3

FD14 Series Oil Drain Coupling

Dimensions (Cap Molded Rubber)

Body Size	Fig.	Dimensions		Dimensions		Part Number Cap (Buna-N)
		A	B	A	B	
		mm	(in)	mm	(in)	
3/8	4	13.2	(.519)	35.6	(1.40)	FD14-1204-06

Dimensions (Cap)

Body Size	Fig.	Dimensions		Dimensions		Part Number Cap (Buna-N)
		A	B	A	B	
		mm	(in)	mm	(in)	
3/8	5	18.4	(.726)	31.8	(1.25)	FD14-1210-06

Swivel Joint

Body Size	Fig.	Thread Size	Cap	Part Number (Buna-N)
3/8	6	3/4-14	Dryseal NPTF	FD14-1004-12-12

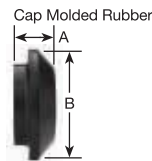

Figure 4

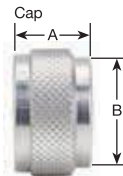

Figure 5



Figure 6



FLUID TRANSFER
AND HYDRAULIC

PNEUMATIC

SPECIAL APPLICATIONS

DIAGNOSTIC

AGRICULTURE

REFRIGERANT

FD17 Series



The Eaton FD17 high pressure coupling can be connected by hand while under pressure up to 5,500 psi/380 bar. This quick disconnect coupling is most commonly used in SCBA transfilling and buddy breathing applications and is commonly found on SCBA equipment certified to various NIOSH, NFPA and CBRN standards.

Product Features

- Connect and disconnect under pressure up to 5,500 psi/380 bar
- Certified on SCBA equipment that meets NIOSH, NFPA and CBRN requirements
- Complies with NFPA 1981 and NFPA 2013
- Standard body material: Stainless steel, aluminum

Physical Characteristics

Series	Max. Operating Pressure		Min. Burst Pressure		Rated Flow*		Rated Temperature
	(bar)	(psi)	(bar)	(psi)	(lpm)	scfm	
FD17	380	5,500	1140	16,500	125	4.4	-40°F (-40°C)/+160°F (+71°C)

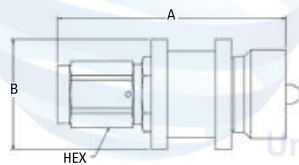

Figure 1

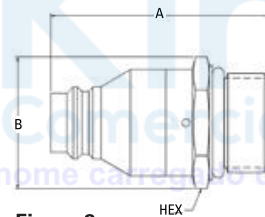

Figure 2

Part Number	Coupling Type	Body Size	Port Size	Thread	Type	Fig.	Dimensions					
							A (in)	B (in)	Hex (in)	A (mm)	B (mm)	Hex (mm)
FD17-1003-04-04	Socket/Female	1/4	-4	7/16-20	ORB	1	2.85	1.38	0.75	72.4	35.1	19.1
FD17-1082-10-04	Plug/Male	1/4	-10	7/8-14	ORB	2	1.93	1.43	1	49.0	36.3	25.4



Male Dust Cap

Part Number

FD17-1064-04*



Female Dust Cap

Part Number

FD17-1062-04

* Indicates patented product

FD69 Series 10,000 psi Water Blast



Eaton's FD69 Series design has a greater surface contact area for long service life in rugged high pressure and water blast applications. The maximum operating pressure is 10,000 psi with 40,000 psi minimum burst pressure.

Product Features

- Safety sleeve lock guards against accidental disconnection
- Smooth bore "straight through" design for high flow fluid requirements
- Heavy duty back-up ring to prevent O-Ring extrusion
- Available in plated steel and stainless steel for added corrosion resistance
- Standard seal material:

Buna-N

- Standard body material: High resistance carbon steel with zinc trivalent plating or stainless steel

Applications & Markets

Physical Characteristics

Coupling Size (in)	Max. Operating Pressure		Min. Burst Pressure Connected		Vacuum Connected Only	Rated Flow		Air Inclusion	Fluid Loss
	(bar)	(psi)	(bar)	(psi)	(in./Hg)	(lpm)	(gpm)	cc. max.	cc.max.
1/2	689	10,000	2,758	40,000	28	170	45	-	-

- High pressure water blast
- Bridge/concrete repair
- Paint stripping
- Shipyards

Flow Data

Pressure Drop Versus Flow Graph

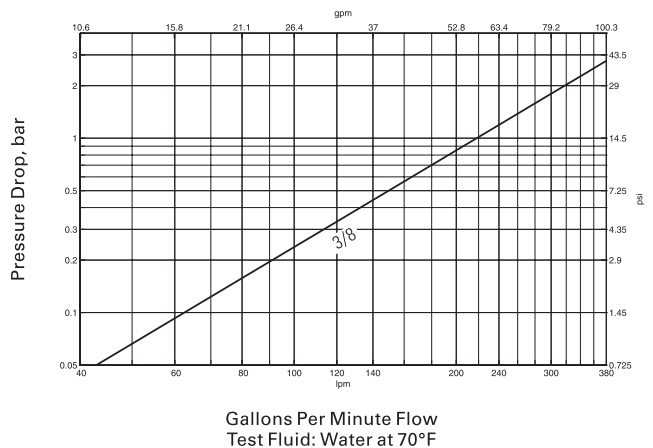

FD69 Series

10,000 psi Water Blast

FLUID TRANSFER
AND HYDRAULIC

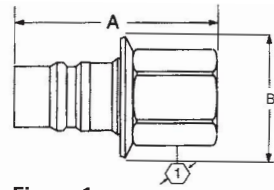

Figure 1

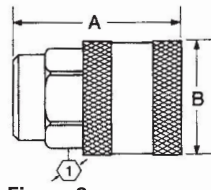

Figure 2

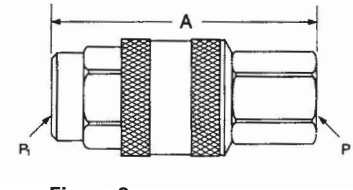

Figure 3

Dimensions (Female NPT)

Part Number	Buna-N	FKM	EPDM	Coupling Type	Body Size	Port Size	Thread	Type	Fig.	Dimensions		Hex			
										A	B	mm	(in)		
Steel											mm	(in)	mm	(in)	
FD69-1002-06-08	FD69-1002-06-08	FD69-1002-06-08	FD69-1002-06-08	Plug/Male*	1/2	3/8	3/8-18	Female NPT	1	47.0	(1.85)	41.7	(1.64)	25.4	(1.00)
FD69-1001-06-08	FD69-1026-06-08	FD69-1028-06-08	FD69-1028-06-08	Socket/Female	1/2	3/8	3/8-18	Female NPT	2	54.1	(2.13)	41.1	(1.62)	31.8	(1.25)
FD69-1002-08-08	FD69-1002-08-08	FD69-1002-08-08	FD69-1002-08-08	Plug/Male*	1/2	1/2	1/2-14	Female NPT	1	59.4	(2.34)	41.7	(1.64)	28.4	(1.12)
FD69-1001-08-08	FD69-1026-08-08	FD69-1028-08-08	FD69-1028-08-08	Socket/Female	1/2	1/2	1/2-14	Female NPT	2	54.1	(2.13)	41.1	(1.62)	31.8	(1.25)
Stainless Steel											mm	(in)	mm	(in)	
FD69-1012-08-08	FD69-1012-08-08	FD69-1012-08-08	FD69-1012-08-08	Plug/Male*	1/2	1/2	1/2-14	Female NPT	1	59.4	(2.34)	41.7	(1.64)	28.4	(1.12)
FD69-1011-08-08	-	-	-	Socket/Female	1/2	1/2	1/2-14	Female NPT	2	54.1	(2.13)	41.1	(1.62)	33.3	(1.31)

*Male halves contain no seals.

Part Number	Buna-N	FKM	EPDM	Coupling Type	Body Size	Port Size	Thread		Type	Fig.	Dimensions	
							(P)	(P1)			A	(in)
Steel											mm	(in)
FD69-1000-080808	FD69-1027-080808	FD69-1029-080808	FD69-1029-080808	Complete	1/2	1/2	1/2-14	1/2-14	Female NPT	3	87.1	(3.43)
FD69-1000-080806	FD69-1027-080806	FD69-1029-080806	FD69-1029-080806	Complete	1/2	1/2 & 3/8	1/2-14	3/8-18	Female NPT	3	87.1	(3.43)
FD69-1000-060808	FD69-1027-060808	FD69-1029-060808	FD69-1029-060808	Complete	1/2	3/8 & 1/2	3/8-18	1/2-14	Female NPT	3	74.7	(2.94)
FD69-1000-060806	FD69-1027-060806	FD69-1029-060806	FD69-1029-060806	Complete	1/2	3/8	3/8-18	3/8-18	Female NPT	3	74.7	(2.94)
Stainless Steel											mm	(in)
FD69-1010-080808	-	-	-	Complete	1/2	1/2	1/2-14	1/2-14	Female NPT	3	87.1	(3.43)

Repair Kit, Female Interface Seal

Part Number	Coupling Size
FF10166	1/2

PNEUMATIC

SPECIAL APPLICATIONS

DIAGNOSTIC

AGRICULTURE

REFRIGERANT

Um nome carregado de soluções

FD83 Series Full Flow Dual Interlock



Eaton's FD83 is designed for fluid transfer and electronics cooling applications where full flow, fluid compatibility and safety are essential. The FD83 identical halves include two interlock features to eliminate spills and ensure maximum safety. Valves cannot be opened until the coupling halves are mated and coupling halves cannot be disconnected until both halves are closed. The FD83 coupling system can be used in a wide variety of low pressure industrial applications.

Product Features

- Dual interlock safety feature eliminates accidental opening of coupling when disconnected with the use of a patented locking pin design and lever handle
- Design provides reliable performance and minimal spillage during maintenance or service
- Standard seal material: EPDM, additional material available on request
- Standard body material: 303 stainless steel, additional material available on request
- Full-flow capability
- Available color coded bumper seals available
- Identical coupling halves
- Maintenance and service friendly
- 303 stainless steel material provides broad fluid compatibility
- 3/4" and 1" Female NPT port threads or hose barb

Physical Characteristics

Coupling Size (in)	Max. Operating Pressure						Min. Burst Pressure						Rated Flow (lpm) (gpm)	Fluid Loss cc. max	
	Connected		Socket/Female Half		Socket/Female Half		Connected		Socket/Female Half		Socket/Female Half				
	(bar)	(psi)	(bar)	(psi)	(bar)	(psi)	(bar)	(psi)	(bar)	(psi)	(bar)	(psi)			
1	10	150	10	150	10	150	20	300	20	300	20	300	189	50	5.0

Dimensions

Part Number	Body Size	Port Size	Thread	Type	Fig.	Dimensions				Hex Ⓢ	
						A		B		mm	(in)
FD83-2052-16-16	1	1	1-11-1/2	Female NPT	1	95.5	(3.76)	71.6	(2.82)	41	(1.63)
FD83-2052-12-16	1	3/4	3/4-14	Female NPT	1	70.1	(2.76)	71.6	(2.83)	41	(1.63)
FD83-2046-16-16	1	1	NA	1" Hose Barb	2	84.2	(3.31)	71.6	(2.82)	-	-

Hose barb adapters available upon request.

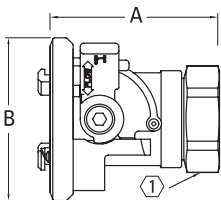

Figure 1

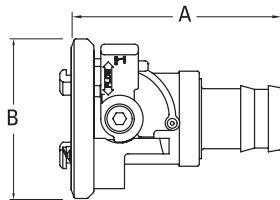
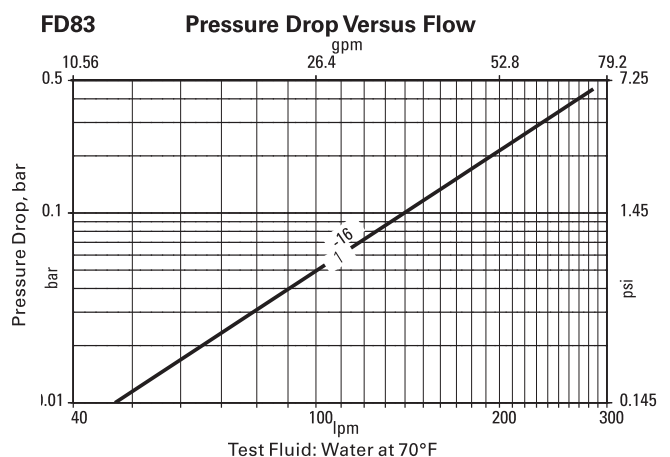

Figure 2

Applications & Markets

- Electronics liquid based cooling
- Thermal management systems
- Industrial fluid transfer

Flow Data



2HKIG/2HKIL Series



Eaton's 2HKIG/2HKIL Series stainless steel couplings can be used with various liquids and gases. They are functionally identical, but do not interchange. They can be used where it is necessary to avoid crossing lines.

Product Features

- Ball Lock
- Proprietary interchange with all stainless steel construction
- Female/Socket halves available with 90° connections
- Standard seal material: Buna-N
- Standard body material: Stainless steel

Physical Characteristics

Body Size (in)	Max. Operating Pressure Connected		Min. Burst Pressure		Rated Flow		All Inclusion	Fluid Loss
	(bar)	(psi)	(bar)	(psi)	(lpm)	(gpm)	cc. max.	cc. max.
1/4	103	1,500	412	6,000	8.3	2.2	2.2	1

Applications & Markets

- Chemical
- Food and Beverage
- Military
- Aerospace

Flow Data

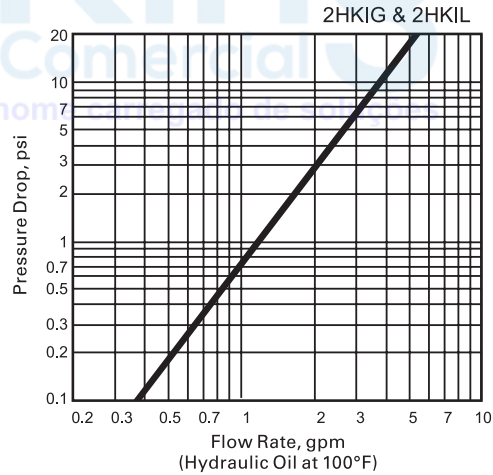

2HKIG Series

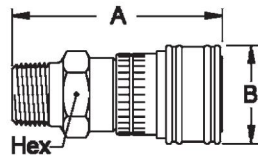

Figure 1

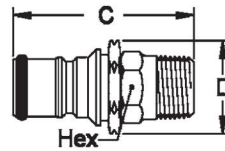

Figure 2

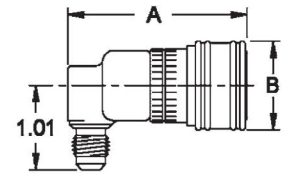

Figure 3

Male End Connections

Part Number	Coupling Type	Body Size	Thread	Fig.	Dimensions		Hex	A	B	Hex
					A	B				
					(in)	(in)	(in)	(mm)	(mm)	(mm)
2HIG10	Socket/Female	1/4	1/8-27 NPTF	1	2.18	1.06	0.81	55.4	26.9	20.6
2HIG15	Socket/Female	1/4	1/4-18 NPTF	1	2.31	1.06	0.81	58.7	26.9	20.6
2HIG20	Socket/Female	1/4	3/8-18 NPTF	1	2.31	1.06	0.81	58.7	26.9	20.6
2HIG720	Socket/Female	1/4	7/16-20 NPTF	1	2.27	1.06	0.81	57.7	26.9	20.6
2HIGLLRA720	Socket/Female	1/4	7/16-20 NPTF	3	2.09	1.06	—	53.1	26.9	—

Part Number	Coupling Type	Body Size	Thread	Fig.	Dimensions		Hex	C	D	Hex
					C	D				
					(in)	(in)	(in)	(mm)	(mm)	(mm)
2KIGF15	Plug/Male	1/4	1/4-18 NPTF	2	1.98	1.01	0.69	50.3	25.7	17.5
2KIGF20	Plug/Male	1/4	3/8-18 NPTF	2	1.98	1.01	0.69	50.3	25.7	17.5

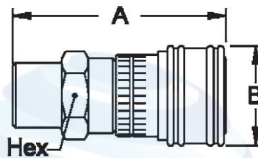

Figure 1

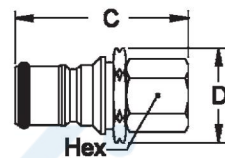

Figure 2

Female End Connections

Part Number	Coupling Type	Body Size	Thread	Fig.	Dimensions		Hex	A	B	Hex
					A	B				
					(in)	(in)	(in)	(mm)	(mm)	(mm)
2HIG11	Socket/Female	1/4	1/8-27 NPTF	1	2.18	1.06	0.81	55.4	26.9	20.6
2HIG16	Socket/Female	1/4	1/4-18 NPTF	1	2.26	1.06	0.81	57.4	26.9	20.6

Part Number	Coupling Type	Body Size	Thread	Fig.	Dimensions		Hex	C	D	Hex
					C	D				
					(in)	(in)	(in)	(mm)	(mm)	(mm)
2KIGF16	Plug/Male	1/4	1/4-18 NPTF	2	1.84	1.01	0.69	46.7	25.7	17.5
2KIGF720	Plug/Male	1/4	7/16-20	2	1.61	1.01	0.69	40.9	25.7	17.5
2KIGF	Plug/Male	1/4	9/16-18	2	1.17	1.01	0.68	29.7	25.7	17.3

FLUID TRANSFER AND HYDRAULIC

PNEUMATIC

SPECIAL APPLICATIONS

DIAGNOSTIC

AGRICULTURE

REFRIGERANT

2HKIL Series

FLUID TRANSFER
AND HYDRAULIC

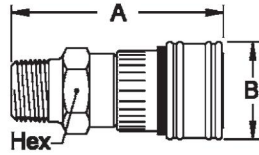

Figure 1

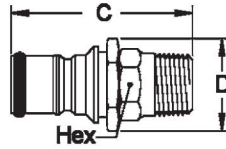

Figure 2

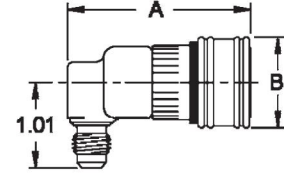

Figure 3

Male End Connections

Part Number	Coupling Type	Body Size	Thread	Fig.	Dimensions		Hex	A	B	Hex
					A	B				
					(in)	(in)	(in)	(mm)	(mm)	(mm)
2HIL10	Socket/Female	1/4	1/8-27 NPTF	1	2.18	1.06	0.81	55.4	26.9	20.6
2HIL15	Socket/Female	1/4	1/4-18 NPTF	1	2.31	1.06	0.81	58.7	26.9	20.6
2HIL20	Socket/Female	1/4	3/8-18 NPTF	1	2.31	1.06	0.81	58.7	26.9	20.6
2HIL720	Socket/Female	1/4	7/16-20 NPTF	1	2.27	1.06	0.81	57.7	26.9	20.6
2HILLRA720	Socket/Female	1/4	7/16-20 NPTF	3	2.09	1.06	—	53.1	26.9	—

Part Number	Coupling Type	Body Size	Thread	Fig.	Dimensions		Hex	C	D	Hex
					C	D				
					(in)	(in)	(in)	(mm)	(mm)	(mm)
2KILF15	Plug/Male	1/4	1/4-18 NPTF	2	1.98	1.01	0.69	50.3	25.7	17.5
2KILF20	Plug/Male	1/4	3/8-18 NPTF	2	1.98	1.01	0.69	50.3	25.7	17.5

PNEUMATIC

SPECIAL APPLICATIONS

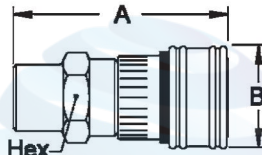

Figure 1

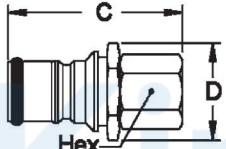

Figure 2

Female End Connections

Part Number	Coupling Type	Body Size	Thread	Fig.	Dimensions		Hex	A	B	Hex
					A	B				
					(in)	(in)	(in)	(mm)	(mm)	(mm)
2HIL11	Socket/Female	1/4	1/8-27 NPTF	1	2.18	1.06	0.81	55.4	26.9	20.6
2HIL16	Socket/Female	1/4	1/4-18 NPTF	1	2.26	1.06	0.81	57.4	26.9	20.6

Part Number	Coupling Type	Body Size	Thread	Fig.	Dimensions		Hex	C	D	Hex
					C	D				
					(in)	(in)	(in)	(mm)	(mm)	(mm)
2KILF16	Plug/Male	1/4	1/4-18 NPTF	2	1.84	1.01	0.69	46.7	25.7	17.5
2KILF720	Plug/Male	1/4	7/16-20	2	1.61	1.01	0.69	40.9	25.7	17.5
2KILF	Plug/Male	1/4	9/16-18	2	1.17	1.01	0.68	29.7	25.7	17.3

DIAGNOSTIC

AGRICULTURE

REFRIGERANT

ST Series



Eaton's ST Series is a straight through coupling that is designed for use where minimum pressure drop is required and valving is not needed. These couplings are suited for various and versatile fluid transfer type systems.

FLUID TRANSFER AND HYDRAULIC

PNEUMATIC

SPECIAL APPLICATIONS

DIAGNOSTIC

AGRICULTURE

REFRIGERANT

Product Features

- Ball latching mechanism
- Smooth bore permits free flow of liquid or gas
- Available in NPTF, BSPP and Hose stem end connections
- Standard seal material: Buna-N
- Standard body material: Brass, 303 stainless steel, steel

Physical Characteristics

Series	Body Size (in)	Max. Operating Pressure Brass Socket & Plug		Max. Operating Pressure Brass Socket & Steel Plug		Max. Operating Pressure Stainless Socket & Plug		Min. Burst Pressure*		Rated Flow	
		(bar)	(psi)	(bar)	(psi)	(bar)	(psi)	(bar)	(psi)	(lpm)	(gpm)
1ST	1/8	193	2,800	234	3,400	290	4,200	772	11,200	10	2.7
2ST	1/4	359	5,200	379	5,500	517	7,500	1,436	20,800	21	5.6
3ST	3/8	193	2,800	290	4,200	434	6,300	772	11,200	57	15
4ST	1/2	152	2,200	241	3,500	248	3,600	608	8,800	83	22
6ST	3/4	117	1,700	145	2,100	207	3,000	468	6,800	250	66
8ST	1	90	1,300	138	2,000	138	2,000	360	5,200	530	140
10ST	1 1/4	117	1,700	186	2,700	152	2,200	468	6,800	697	184
12ST	1 1/2	97	1,400	152	2,200	172	2,500	388	5,600	1,124	297
16ST	2	97	1,400	152	2,200	103	1,500	388	5,600	1,855	490
20ST	2 1/2	62	900	103	1,500	—	—	248	3,600	3,131	827

*For brass socket and plug. Other materials have 4 to 1 safety factor

Applications & Markets

- Fluid Transfer
- Chemical
- Food and Beverage
- Injection Molding
- Marine
- Medical
- Pressure Washing
- Steam Cleaning

Flow Data

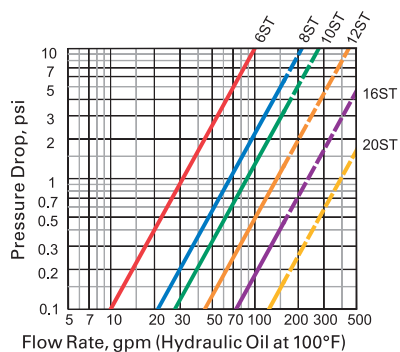
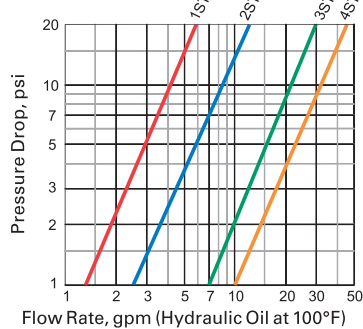

ST Series

FLUID TRANSFER
AND HYDRAULIC

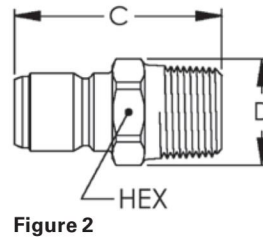
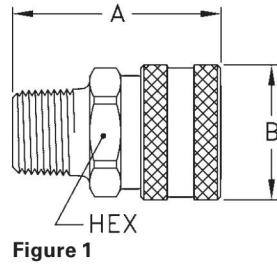

Figure 1

Figure 2

Male End Connections

Part Number	Brass	Steel	Stainless	Coupling Type	Body Size	Port Size	Thread	Type	Fig.	Dimensions						
										A	B	Hex	A	B	Hex	
											(in)	(in)	(in)	(mm)	(mm)	(mm)
1S10	—	—	LL1S10	Socket/Female	1/8	1/8	1/8-27	NPTF	1	1.06	0.72	0.56	26.9	18.3	14.2	
1S10BS	—	—	—	Socket/Female	1/8	1/8	1/8-28	BSPP	1	1.00	0.72	0.56	25.4	18.3	14.2	
2S15	—	—	LL2S15	Socket/Female	1/4	1/4	1/4-18	NPTF	1	1.72	0.97	0.81	43.7	24.6	20.6	
3S20	—	—	LL3S20	Socket/Female	3/8	3/8	3/8-18	NPTF	1	1.75	1.16	1.00	44.5	29.5	25.4	
3S20BS	—	—	LL3S20BS	Socket/Female	3/8	3/8	3/8-19	BSPP	1	1.71	1.16	1.00	43.4	29.5	25.4	
4S25	—	—	LL4S25	Socket/Female	1/2	1/2	1/2-14	NPTF	1	2.03	1.34	1.13	51.6	34.0	28.7	
4S25BS	—	—	LL4S25BS	Socket/Female	1/2	1/2	1/2-14	BSPP	1	1.80	1.34	1.13	45.7	34.0	28.7	
6S30	—	—	LL6S30	Socket/Female	3/4	3/4	3/4-14	NPTF	1	2.22	1.72	1.44	56.4	43.7	36.6	
6S30BS	—	—	—	Socket/Female	3/4	3/4	3/4-14	BSPP	1	2.03	1.72	1.44	51.6	43.7	36.6	
8S35	—	—	—	Socket/Female	1	1	1-11 1/2	NPTF	1	2.53	2.03	1.75	64.3	51.6	44.5	
8S35BS	—	—	—	Socket/Female	1	1	1-11	BSPP	1	2.37	2.03	1.75	60.2	51.6	44.5	

Part Number	Brass	Steel	Stainless	Coupling Type	Body Size	Port Size	Thread	Type	Fig.	Dimensions						
										C	D	Hex	C	D	Hex	
											(in)	(in)	(in)	(mm)	(mm)	(mm)
B1T10	1T10E	—	LL1T10	Plug/Male	1/8	1/8	1/8-27	NPTF	2	1.06	0.51	0.44	26.9	13.0	11.2	
B1T15	1T15	—	—	Plug/Male	1/8	1/4	1/4-18	NPTF	2	1.22	0.65	0.56	31.0	16.5	14.2	
B2T15	2T15	—	LL2T15	Plug/Male	1/4	1/4	1/4-18	NPTF	2	1.56	0.65	0.56	39.6	16.5	14.2	
—	—	—	HL2T15**	Plug/Male	1/4	1/4	1/4-18	NPTF	2	1.56	0.65	0.56	39.6	16.5	14.2	
B2T15BS	—	—	LL2T15BS	Plug/Male	1/4	1/4	1/4-19	BSPP	2	1.46	0.87	0.75	37.1	22.1	19.1	
B3T20	3T20	—	LL3T20	Plug/Male	3/8	3/8	3/8-18	NPTF	2	1.69	0.79	0.69	42.9	20.1	17.5	
—	—	—	HL3T20**	Plug/Male	3/8	3/8	3/8-18	NPTF	2	1.69	0.79	0.69	42.9	20.1	17.5	
B3T20BS	—	—	LL3T20BS	Plug/Male	3/8	3/8	3/8-19	BSPP	2	1.50	1.01	0.88	38.1	25.7	22.4	
B4T25	4T25	—	LL4T25	Plug/Male	1/2	1/2	1/2-14	NPTF	2	2.01	1.01	0.88	51.1	25.7	22.4	
B4T25BS	—	—	LL4T25BS	Plug/Male	1/2	1/2	1/2-14	BSPP	2	1.82	1.15	1.00	46.2	29.2	25.4	
B6T30	6T30	—	LL6T30	Plug/Male	3/4	3/4	3/4-14	NPTF	2	2.2	1.23	1.06	55.9	31.2	26.9	
B6T30BS	—	—	LL6T30BS	Plug/Male	3/4	3/4	3/4-14	BSPP	2	2.08	1.44	1.25	52.8	36.6	31.8	
B8T35	8T35	—	LL8T35	Plug/Male	1	1	1-11 1/2	NPTF	2	2.49	1.59	1.38	63.2	40.4	35.1	
B8T35BS	—	—	—	Plug/Male	1	1	1-11	BSPP	2	2.36	2.02	1.75	59.9	51.3	44.5	
B10T40	10T40	—	LL10T40	Plug/Male	1 1/4	1 1/4	1 1/4-11 1/2	NPTF	2	2.72	2.02	1.75	69.1	51.3	44.5	
B10T40BS	—	—	—	Plug/Male	1 1/4	1 1/4	1 1/4-11	BSPP	2	2.55	2.31	2.00	64.8	58.7	50.8	
B12T45	12T45	—	—	Plug/Male	1 1/2	1 1/2	1 1/2-11 1/2	NPTF	2	3.31	2.6	2.25	84.1	66.0	57.2	
B12T45BS	—	—	—	Plug/Male	1 1/2	1 1/2	1 1/2-11	BSPP	2	3.06	2.6	2.25	77.7	66.0	57.2	
B16T50	16T50	—	LL16T50	Plug/Male	2	2	2-11 1/2	NPTF	2	3.5	3.18	2.75	88.9	80.8	69.9	
B20T55	—	—	—	Plug/Male	2 1/2	2 1/2	2 1/2-8	NPTF	2	4.24	3.75	3.25	107.7	95.3	82.6	

**High impulse heat treated 416 stainless steel

PNEUMATIC

SPECIAL APPLICATIONS

DIAGNOSTIC

AGRICULTURE

REFRIGERANT

ST Series

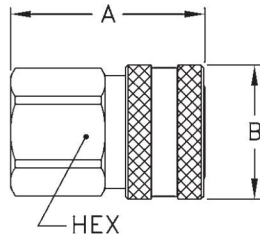

Figure 1

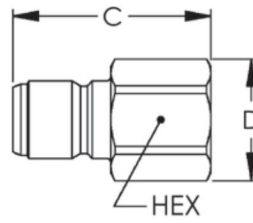

Figure 2

Female End Connections

Part Number	Brass	Steel	Stainless	Coupling Type	Body Size	Port Size	Thread	Type	Fig.	Dimensions						
										A	B	Hex	A	B	Hex	
											(in)	(in)	(in)	(mm)	(mm)	(mm)
1S11	—	—	LL1S11	Socket/Female	1/8	1/8	1/8-27	NPTF	1	1.06	0.72	0.56	26.9	18.3	14.2	
1S11BS	—	—	LL1S11BS	Socket/Female	1/8	1/8	1/8-28	BSPP	1	1.03	0.72	0.56	26.2	18.3	14.2	
2S16	—	—	LL2S16	Socket/Female	1/4	1/4	1/4-18	NPTF	1	1.5	0.97	0.81	38.1	24.6	20.6	
2S16BS	—	—	LL2S16BS	Socket/Female	1/4	1/4	1/4-19	BSPP	1	1.5	0.97	0.81	38.1	24.6	20.6	
3S21	—	—	LL3S21	Socket/Female	3/8	3/8	3/8-18	NPTF	1	1.59	1.16	1.00	40.4	29.5	25.4	
3S21BS	—	—	LL3S21BS	Socket/Female	3/8	3/8	3/8-19	BSPP	1	1.59	1.16	1.00	40.4	29.5	25.4	
4S26	—	—	LL4S26	Socket/Female	1/2	1/2	1/2-14	NPTF	1	1.91	1.34	1.13	48.5	34.0	28.7	
4S26BS	—	—	LL4S26BS	Socket/Female	1/2	1/2	1/2-14	BSPP	1	1.91	1.34	1.13	48.5	34.0	28.7	
6S31	—	—	LL6S31	Socket/Female	3/4	3/4	3/4-14	NPTF	1	2.06	1.72	1.44	52.3	43.7	36.6	
6S31BS	—	—	LL6S31BS	Socket/Female	3/4	3/4	3/4-14	BSPP	1	2.06	1.72	1.44	52.3	43.7	36.6	
8S36	—	—	LL8S36	Socket/Female	1	1	1-11 1/2	NPTF	1	2.33	2.03	1.75	59.2	51.6	44.5	
8S36BS	—	—	LL8S36BS	Socket/Female	1	1	1-11	BSPP	1	2.33	2.03	1.75	59.2	51.6	44.5	
10S41*	—	—	LL10S41	Socket/Female	1 1/4	1 1/4	1 1/4-11 1/2	NPTF	1	2.44	2.5	2.00	62.0	63.5	50.8	
10S41BS*	—	—	—	Socket/Female	1 1/4	1 1/4	1 1/4-11	BSPP	1	2.51	2.5	2.00	63.8	63.5	50.8	
12S46*	—	—	LL12S46	Socket/Female	1 1/2	1 1/2	1 1/2-11 1/2	NPTF	1	2.88	3.13	2.60	73.2	79.5	66.0	
12S46BS*	—	—	LL12S46BS	Socket/Female	1 1/2	1 1/2	1 1/2-11	BSPP	1	2.88	3.13	2.63	73.2	79.5	66.8	
16S51*	—	—	LL16S51	Socket/Female	2	2	2-11 1/2	NPTF	1	3.09	3.75	3.00	78.5	95.3	76.2	
16S51BS*	—	—	LL16S51BS	Socket/Female	2	2	2-11	BSPP	1	3.3	3.75	3.00	83.8	95.3	76.2	
20S56*	—	—	—	Socket/Female	2 1/2	2 1/2	2 1/2-8	NPTF	1	3.44	4.5	3.50	87.4	114.3	88.9	

Part Number	Brass	Steel	Stainless	Coupling Type	Body Size	Port Size	Thread	Type	Fig.	Dimensions						
										C	D	Hex	C	D	Hex	
											(in)	(in)	(in)	(mm)	(mm)	(mm)
B1T11	—	1T11	LL1T11	Plug/Male	1/8	1/8	1/8-27	NPTF	2	0.97	0.58	0.50	24.6	14.7	12.7	
B1T11BS	—	—	LL1T11BS	Plug/Male	1/8	1/8	1/8-28	BSPP	2	0.97	0.65	0.56	24.6	16.5	14.2	
B2T16	—	2T16	LL2T16	Plug/Male	1/4	1/4	1/4-18	NPTF	2	1.45	0.79	0.69	36.8	20.1	17.5	
—	—	—	HL2T16**	Plug/Male	1/4	1/4	1/4-18	NPTF	2	1.45	0.79	0.69	36.8	20.1	17.5	
B2T16BS	—	—	LL2T16BS	Plug/Male	1/4	1/4	1/4-19	BSPP	2	1.45	0.87	0.75	36.8	22.1	19.1	
B3T21	—	3T21	LL3T21	Plug/Male	3/8	3/8	3/8-18	NPTF	2	1.63	0.94	0.81	41.4	23.9	20.6	
—	—	—	HL3T21**	Plug/Male	3/8	3/8	3/8-18	NPTF	2	1.63	0.94	0.81	41.4	23.9	20.6	
B3T21BS	—	—	LL3T21BS	Plug/Male	3/8	3/8	3/8-19	BSPP	2	1.63	1.01	0.88	41.4	25.7	22.4	
B4T26	—	4T26	LL4T26	Plug/Male	1/2	1/2	1/2-14	NPTF	2	1.92	1.15	1.00	48.8	29.2	25.4	
B4T26BS	—	—	LL4T26BS	Plug/Male	1/2	1/2	1/2-14	BSPP	2	1.92	1.23	1.06	48.8	31.2	26.9	
B6T31	—	6T31	LL6T31	Plug/Male	3/4	3/4	3/4-14	NPTF	2	2.01	1.37	1.19	51.1	34.8	30.2	
B6T31BS	—	—	LL6T31BS	Plug/Male	3/4	3/4	3/4-14	BSPP	2	2.01	1.51	1.31	51.1	38.4	33.3	
B8T36	—	8T36	LL8T36	Plug/Male	1	1	1-11 1/2	NPTF	2	2.21	1.8	1.56	56.1	45.7	39.6	
B8T36BS	—	—	LL8T36BS	Plug/Male	1	1	1-11	BSPP	2	2.23	1.8	1.56	56.6	45.7	39.6	
B10T41	—	10T41	LL10T41	Plug/Male	1 1/4	1 1/4	1 1/4-11 1/2	NPTF	2	2.34	2.31	2.00	59.4	58.7	50.8	
B10T41BS	—	—	LL10T41BS	Plug/Male	1 1/4	1 1/4	1 1/4-11	BSPP	2	2.53	2.31	2.00	64.3	58.7	50.8	
B12T46	—	12T46	LL12T46	Plug/Male	1 1/2	1 1/2	1 1/2-11 1/2	NPTF	2	2.88	2.6	2.25	73.2	66.0	57.2	
B12T46BS	—	—	LL12T46BS	Plug/Male	1 1/2	1 1/2	1 1/2-11	BSPP	2	2.88	2.6	2.25	73.2	66.0	57.2	
B16T51	—	16T51	—	Plug/Male	2	2	2-11 1/2	NPTF	2	3.03	3.18	2.75	77.0	80.8	69.9	
B16T51BS	—	—	—	Plug/Male	2	2	2-11	BSPP	2	3.25	3.18	2.75	82.6	80.8	69.9	
B20T56	—	20T56	—	Plug/Male	2 1/2	2 1/2	2 1/2-8	NPTF	2	3.37	3.75	3.25	85.6	95.3	82.6	

*With Steel Sleeve

** High impulse heat treated 416 stainless steel

FLUID TRANSFER AND HYDRAULIC

PNEUMATIC

SPECIAL APPLICATIONS

DIAGNOSTIC

AGRICULTURE

REFRIGERANT

ST Series

FLUID TRANSFER
AND HYDRAULIC

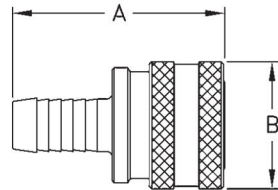

Figure 1

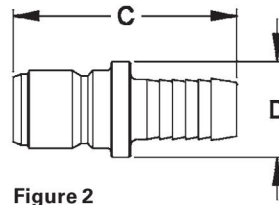

Figure 2

Hose Stem End Connections

Part Number	Brass	Stainless	Steel	Coupling Type	Body Size	Hose I.D.	Fig.	Dimensions			
								A	B	A	B
								(in)	(in)	(mm)	(mm)
1S12		LL1S12	—	Socket/Female	1/8	3/16	1	1.41	0.72	35.8	18.3
1S17		LL1S17	—	Socket/Female	1/8	1/4	1	1.41	0.72	35.8	18.3
2S17		LL2S17	—	Socket/Female	1/4	1/4	1	2.10	0.97	53.3	24.6
3S22		LL3S22	—	Socket/Female	3/8	3/8	1	2.09	1.16	53.1	29.5
4S27		LL4S27	—	Socket/Female	1/2	1/2	1	2.19	1.34	55.6	34.0
6S32		LL6S32	—	Socket/Female	3/4	3/4	1	3.19	1.72	81.0	43.7
8S37		LL8S37	—	Socket/Female	1	1	1	3.32	2.03	84.3	51.6

Part Number	Brass	Stainless	Steel	Coupling Type	Body Size	Hose I.D.	Fig.	Dimensions			
								C	D	C	D
								(in)	(in)	(mm)	(mm)
B1T12		LL1T12	—	Plug/Male	1/8	3/16	2	1.28	0.44	32.5	11.2
B1T17		LL1T17	—	Plug/Male	1/8	1/4	2	1.28	0.44	32.5	11.2
B2T17		LL2T17	—	Plug/Male	1/4	1/4	2	1.93	0.56	49.0	14.2
B3T22		LL3T22	—	Plug/Male	3/8	3/8	2	2.09	0.69	53.1	17.5
B4T27		LL4T27	—	Plug/Male	1/2	1/2	2	2.17	0.88	55.1	22.4
B6T32		LL6T32	—	Plug/Male	3/4	3/4	2	3.17	1.19	80.5	30.2
B8T37		—	8T37	Plug/Male	1	1	2	3.28	1.5	83.3	38.1

PNEUMATIC

SPECIAL APPLICATIONS

Dust Caps and Dust Plugs

Series	Dust Cap	Dust Plug
2ST	—	PSDC1HK
3ST	—	PSDC2HK
6ST	PPDC4HK	PSDC4HK
8ST	PPDC6HK	—
10ST	PPDC8HK	—



DIAGNOSTIC

AGRICULTURE

REFRIGERANT

Flo-Temp Series



Eaton's Flo-Temp™ quick disconnect couplings provide the flow needed to cool or heat molds and die casting dies. Sockets are available non-valved for maximum flow and valved to prevent fluid loss when disconnected. Flo-Temp couplings can be used with water-glycol, hot water and hot oil.

Product Features

- Non valved straight through models for maximum flow
- Valved sockets/females for automatic shut-off when line is disconnected
- Sockets/Females available with straight, 90° or 45° hose stems or without hose stem
- Brass plugs/males with male pipe thread for recessed mounting to avoid damage to plugs/males when molds are being changed or stored.
- Standard body material: Brass

Physical Characteristics

Size (in)	Max. Operating Pressure		Min. Burst Pressure		Rated Flow	
	(bar)	(psi)	(bar)	(psi)	(lpm)	(gpm)
1/4	14	200	56	800	8.3	2.2
3/8	14	200	56	800	17	4.5
1/2	14	200	56	800	49	13

Applications & Markets

- Injection Molding
- Heating and Cooling

Flow Data

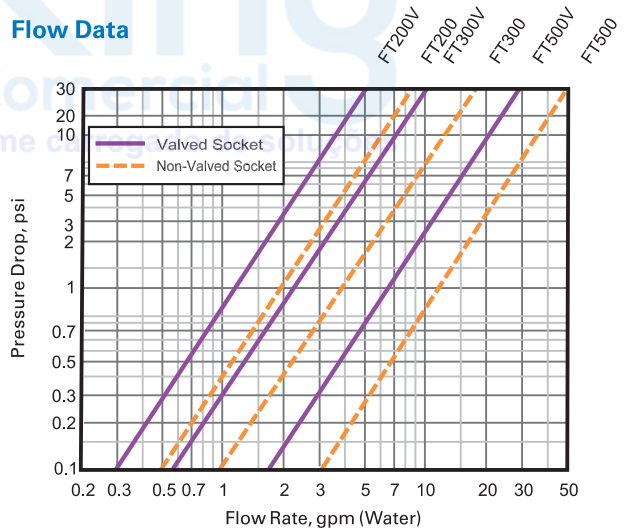

FLUID TRANSFER
AND HYDRAULIC

PNEUMATIC

SPECIAL APPLICATIONS

DIAGNOSTIC

AGRICULTURE

REFRIGERANT

Flo-Temp Series

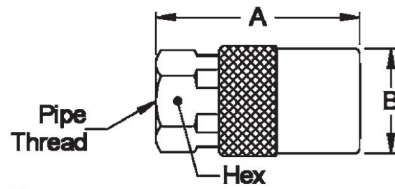

Figure 1

Without Hose Stem

Part Number	Coupling Type	Body Size	Port Size	Thread	Type	Fig.	Dimensions					
							A (in)	B (in)	Hex (in)	A (mm)	B (mm)	Hex (mm)
LNFT200	Socket/Female	1/4	1/8	1/8-27	NPTF	1	1.68	0.67	0.56	42.7	17.0	14.2
LNFT300	Socket/Female	3/8	1/4	1/4-18	NPTF	1	2.18	0.89	0.75	55.4	22.6	19.1
LNFT500	Socket/Female	1/2	1/2	1/2-14	NPTF	1	2.00	1.17	1.13	50.8	29.7	28.7

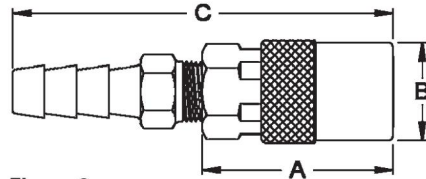

Figure 2

Straight Hose Stem

Part Number Non-Valved	Coupling Type Valved	Body Size	Type	Hose I.D.	Fig.	Dimensions						
						A (in)	B (in)	C (in)	A (mm)	B (mm)	C (mm)	
FTS204	FTS204V	Socket/Female	1/4	Hose Stem	1/4	2	1.20	0.67	2.25	30.5	17.0	57.2
FTS204HP*	FTS204VHP*	Socket/Female	1/4	Hose Stem	1/4	2	1.20	0.67	2.09	30.5	17.0	53.1
FTS205	FTS205V	Socket/Female	1/4	Hose Stem	5/16	2	1.20	0.67	2.09	30.5	17.0	53.1
FTS206	FTS206V	Socket/Female	1/4	Hose Stem	3/8	2	1.20	0.67	2.25	30.5	17.0	57.2
FTS206HP*		Socket/Female	1/4	Hose Stem	3/8	2	1.20	0.67	2.34	30.5	17.0	59.4
FTS306	FTS306V	Socket/Female	3/8	Hose Stem	3/8	2	1.60	0.91	2.68	40.6	23.1	68.1
FTS306HP*	FTS306VHP*	Socket/Female	3/8	Hose Stem	3/8	2	1.61	0.89	2.75	40.9	22.6	69.9
FTS308	FTS308V	Socket/Female	3/8	Hose Stem	1/2	2	1.61	0.88	2.82	40.9	22.4	71.6
FTS308HP*	FTS308VHP*	Socket/Female	3/8	Hose Stem	1/2	2	1.61	0.88	2.82	40.9	22.4	71.6
FTS504	FTS504V	Socket/Female	1/2	Hose Stem	1/2	2	2.25	1.18	3.42	57.2	30.0	86.9
FTS504HP*	FTS504VHP*	Socket/Female	1/2	Hose Stem	1/2	2	2.25	1.18	3.62	57.2	30.0	91.9
FTS506	FTS506V	Socket/Female	1/2	Hose Stem	3/4	2	2.22	1.18	3.85	56.4	30.0	97.8
FTS506HP*	FTS506VHP*	Socket/Female	1/2	Hose Stem	3/4	2	2.22	1.18	4.35	56.4	30.0	110.5

*Part numbers with HP suffix have pushon hose barb. All other FTS parts numbers have standard hose barb.

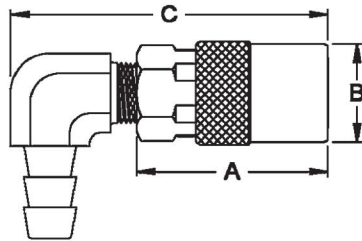

Figure 3

90° Hose Stem

Part Number Non-Valved	Coupling Type Valved	Body Size	Type	Hose I.D.	Fig.	Dimensions						
						A (in)	B (in)	C (in)	A (mm)	B (mm)	C (mm)	
FTS214	FTS214V	Socket/Female	1/4	Hose Stem	1/4	3	1.36	0.67	2.17	34.5	17.0	55.1
FTS214HP*	FTS214VHP*	Socket/Female	1/4	Hose Stem	1/4	3	1.18	0.67	1.76	30.0	17.0	44.7
FTS215	FTS215V	Socket/Female	1/4	Hose Stem	5/16	3	1.18	0.67	1.76	30.0	17.0	44.7
FTS216	FTS216V	Socket/Female	1/4	Hose Stem	3/8	3	1.17	0.67	1.76	29.7	17.0	44.7
FTS216HP*	FTS216VHP*	Socket/Female	1/4	Hose Stem	3/8	3	1.17	0.67	1.76	29.7	17.0	44.7
FTS316	FTS316V	Socket/Female	3/8	Hose Stem	3/8	3	1.60	0.88	2.43	40.6	22.4	61.7
FTS316HP*	FTS316VHP*	Socket/Female	3/8	Hose Stem	3/8	3	1.60	0.88	2.43	40.6	22.4	61.7
FTS318	FTS318V	Socket/Female	3/8	Hose Stem	1/2	3	1.60	0.88	2.43	40.6	22.4	61.7
FTS318HP*	FTS318VHP*	Socket/Female	3/8	Hose Stem	1/2	3	1.60	0.88	2.43	40.6	22.4	61.7

*Part numbers with HP suffix have pushon hose barb. All other FTS parts numbers have standard hose barb.

FLUID TRANSFER AND HYDRAULIC

PNEUMATIC

SPECIAL APPLICATIONS

DIAGNOSTIC

AGRICULTURE

REFRIGERANT

Flo-Temp Series

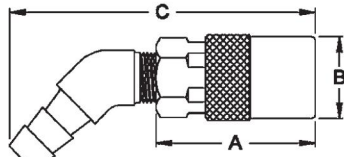

Figure 4

45° Hose Stem

Part Number Non-Valved	Valved	Coupling Type	Body Size	Type	Hose I.D.	Fig.	Dimensions					
							A	B	C	A	B	C
							(in)	(in)	(in)	(mm)	(mm)	(mm)
FTS224	FTS224V	Socket/Female	1/4	Hose Stem	1/4	4	1.17	0.67	2.40	29.7	17.0	61.0
FTS224HP*	FTS224VHP*	Socket/Female	1/4	Hose Stem	1/4	4	1.17	0.67	2.40	29.7	17.0	61.0
FTS225	FTS225V	Socket/Female	1/4	Hose Stem	5/16	4	1.17	0.67	2.40	29.7	17.0	61.0
FTS226	FTS226V	Socket/Female	1/4	Hose Stem	3/8	4	1.17	0.67	2.40	29.7	17.0	61.0
FTS226HP*	FTS226VHP*	Socket/Female	1/4	Hose Stem	3/8	4	1.17	0.67	2.40	29.7	17.0	61.0
FTS326	FTS326V	Socket/Female	3/8	Hose Stem	3/8	4	1.80	0.90	3.70	45.7	22.9	94.0
FTS326HP*	FTS326VHP*	Socket/Female	3/8	Hose Stem	3/8	4	1.80	0.90	3.17	45.7	22.9	80.5
FTS328	FTS328V	Socket/Female	3/8	Hose Stem	1/2	4	1.60	0.90	3.17	40.6	22.9	80.5
FTS328HP*	FTS328VHP*	Socket/Female	3/8	Hose Stem	1/2	4	1.60	0.90	3.17	40.6	22.9	80.5

*Part numbers with HP suffix have pushon hose barb. All other FTS parts numbers have standard hose barb

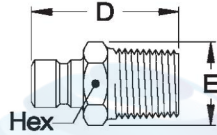

Figure 5

Male Pipe Thread

Part Number	Coupling Type	Body Size	Port Size	Thread	Type	Fig.	Dimensions						Installation Recess			
							A	B	C	A	B	C	DIA	Depth	DIA	Depth
							(in)	(in)	(in)	(mm)	(mm)	(mm)	(in)	(in)	(mm)	(mm)
FTP251	Plug/Male	1/4	1/8	1/8-27	NPTF	5	0.94	0.49	0.44	23.9	12.4	11.2	0.69	0.69	17.5	17.5
FTP251BST	Plug/Male	1/4	1/8	1/8-28	BSPT	5	0.94	0.49	0.44	23.9	12.4	11.2	0.69	0.69	17.5	17.5
FTP252	Plug/Male	1/4	1/4	1/4-18	NPTF	5	1.15	0.63	0.56	29.2	16.0	14.2	0.84	0.94	21.3	23.9
FTP252BST	Plug/Male	1/4	1/4	1/4-19	BSPT	5	1.15	0.63	0.56	29.2	16.0	14.2	0.84	0.94	21.3	23.9
FTP253	Plug/Male	1/4	3/8	3/8-18	NPTF	5	1.19	0.77	0.69	30.2	19.6	17.5	1.00	0.94	25.4	23.9
FTP352	Plug/Male	3/8	1/4	1/4-18	NPTF	5	1.40	0.63	0.56	35.6	16.0	14.2	1.00	1.09	25.4	27.7
FTP352BST	Plug/Male	3/8	1/4	1/4-19	BSPT	5	1.40	0.63	0.56	35.6	16.0	14.2	1.00	1.09	25.4	27.7
FTP353	Plug/Male	3/8	3/8	3/8-18	NPTF	5	1.40	0.77	0.69	35.6	19.6	17.5	1.00	1.13	25.4	28.7
FTP353BST	Plug/Male	3/8	3/8	3/8-19	BSPT	5	1.40	0.77	0.69	35.6	19.6	17.5	1.00	1.13	25.4	28.7
FTP354	Plug/Male	3/8	1/2	1/2-14	NPTF	5	1.56	0.98	0.88	39.6	24.9	22.4	1.19	1.25	30.2	31.8
FTP554	Plug/Male	1/2	1/2	1/2-14	NPTF	5	1.75	0.98	0.88	44.5	24.9	22.4	1.25	1.50	31.8	38.1
FTP556	Plug/Male	1/2	3/4	3/4-14	NPTF	5	1.75	1.25	1.13	44.5	31.8	28.7	1.50	1.56	38.1	39.6

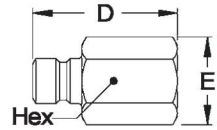
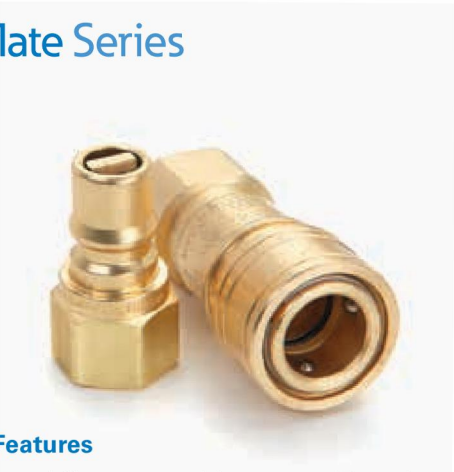

Figure 6

Female End Connections

Part Number	Coupling Type	Body Size	Port Size	Thread	Type	Fig.	Dimensions					
							D	E	Hex	D	E	Hex
							(in)	(in)	(in)	(mm)	(mm)	(mm)
FTP251F	Plug/Male	1/4	1/8	1/8-27	NPTF	6	1.00	0.58	0.50	25.4	14.7	12.7
FTP251FBS	Plug/Male	1/8	1/8	1/8-28	BSPT	6	1.00	0.65	0.56	25.4	16.5	14.2
FTP252F	Plug/Male	1/4	1/4	1/4-18	NPTF	6	1.20	0.72	0.63	30.5	18.3	16.0
FTP252FBS	Plug/Male	1/4	1/4	1/4-19	BSPT	6	1.20	0.87	0.75	30.5	22.1	19.1
FTP253F	Plug/Male	1/4	3/8	3/8-18	NPTF	6	1.25	0.87	0.75	31.8	22.1	19.1
FTP352F	Plug/Male	3/8	1/4	1/4-18	NPTF	6	1.38	0.72	0.63	35.1	18.3	16.0
FTP352FBS	Plug/Male	1/4	1/4	1/4-19	BSPT	6	1.28	0.87	0.75	32.5	22.1	19.1
FTP353F	Plug/Male	3/8	3/8	3/8-18	NPTF	6	1.40	0.87	0.75	35.6	22.1	19.1
FTP354F	Plug/Male	3/8	1/2	1/2-14	NPTF	6	1.62	1.08	0.94	41.1	27.4	23.9
FTP554F	Plug/Male	1/2	1/2	1/2-14	NPTF	6	1.72	1.08	0.94	43.7	27.4	23.9
FTP556F	Plug/Male	1/2	3/4	3/4-14	NPTF	6	1.78	1.30	1.13	45.2	33.0	28.7

Gas-Mate Series



Eaton's Gas-Mate™ Series quick disconnect couplings are a one-way shut-off safety couplings designed for the connection of gas fired devices or applications.

Product Features

- Connect and disconnect without the need for wrenches
- Automatic shut off when plug is removed from socket
- In case of fire, heat sensitive plug allows socket valve to close, stopping gas flow
- Tested to meet operating temperatures -40°F to 200°F (-40°C to 93°C) in sizes 3/8", 1/2", 3/4", and 1" when used in accordance with the CSA standard ANSI Z21.41b-2010/CSA 6.9b-2010 in both indoor and outdoor applications. Please note that the 1 1/4" size coupling is rated for indoor use only.
- Standard body material: Brass

Physical Characteristics

Sizes	Max. Operating Pressure		Min. Burst Pressure		Rated Flow	
	(bar)	(psi)	(bar)	(psi)	(lpm)	(gpm)
All sizes	0.03	0.5	68	1,000	See Chart	See Chart

Applications & Markets

- Industrial
- Fuel Gas Systems
- Food & Beverage



Complies with the requirements of ANSI Z21.41B-2010/CSA 6.96-2010.

*CSA design certified, in both the United States and Canada, for natural gas, manufactured gas, liquified petroleum and LP gas-air mixtures at pressures not in excess of 1/2 psig (3.5 kPa).

Um novo legado de soluções

Body Size (in)	Socket/Female P/N	Plug/Male P/N	Capacity (btu/hr)
3/8	100006E	100506	60,000
1/2	100008	100508	90,000
3/4	100010	100510	245,000
1	100012E	100512	310,000
1 1/4	GMS1250FH	GMP1250F	500,000

*Capacity is based on natural gas having a specific gravity of 0.64 and heat capacity of 1,000 BTU per cubic foot. Inlet pressure is 12 inches water column and the pressure drop is 0.3 inch water column.

Gas-Mate Series

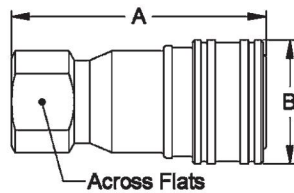

Figure 1

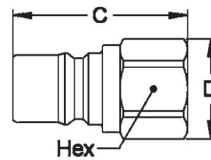

Figure 2

Sockets/Females

Part Number	Coupling Type	Body Size	Port Size	Thread	Type	Fig.	Dimensions			A	B	Across Flats
							A	B	Across Flats			
							(in)	(in)	(in)	(mm)	(mm)	(mm)
100006E	Socket/Female	3/8	3/8	3/8-18	NPTF	1	2.44	1.13	0.87	62.0	28.7	22.1
100008	Socket/Female	1/2	1/2	1/2-14	NPTF	1	2.84	1.38	1.00	72.1	35.1	25.4
100010	Socket/Female	3/4	3/4	3/4-14	NPTF	1	3.17	1.75	1.31	80.5	44.5	33.3
100012E	Socket/Female	1	1	1-11 1/2	NPTF	1	3.94	2.13	1.50	100.1	54.1	38.1

Part Number	Coupling Type	Body Size	Port Size	Thread	Type	Fig.	Dimensions			A	B	Hex
							A	B	Hex			
							(in)	(in)	(in)	(mm)	(mm)	(mm)
GMS1250FH*	Socket/Female	1 1/4	1 1/4	1 1/4-11 1/2	NPTF	3	4.15	2.28	2.00	105.4	57.9	50.8

*For indoor use only

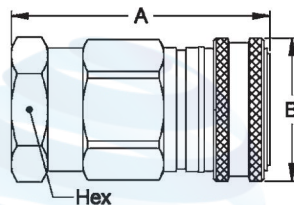

Figure 3

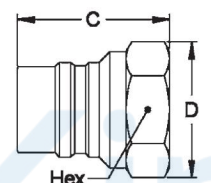

Figure 4

Plugs/Males

Part Number	Coupling Type	Body Size	Port Size	Thread	Type	Fig.	Dimensions			C	D	Hex
							C	D	Hex			
							(in)	(in)	(in)	(mm)	(mm)	(mm)
100506	Plug/Male	3/8	3/8	3/8-18	NPTF	2	1.59	0.94	0.81	40.4	23.9	20.6
100508	Plug/Male	1/2	1/2	1/2-14	NPTF	2	1.94	1.15	1.00	49.3	29.2	25.4
100510	Plug/Male	3/4	3/4	3/4-14	NPTF	2	2.06	1.51	1.31	52.3	38.4	33.3
100512	Plug/Male	1	1	1-11 1/2	NPTF	2	2.47	1.73	1.50	62.7	43.9	38.1
GMP1250F*	Plug/Male	1 1/4	1 1/4	1 1/4-11 1/2	NPTF	4	2.44	2.17	1.88	62.0	55.1	47.8

*For indoor use only

Dust Caps and Dust Plugs

Series	Dust Cap		Dust Plug	
	Metal	Vinyl	Metal	Vinyl
3/8	PDC2HK*	PPDC2HK	PDC2HK*	PPDC2HK
1/2	PDC3HK*	PPDC3HK	PDC3HK*	PPDC3HK
3/4	PDC4HK**	PPDC4HK	PDC4HK**	PPDC4HK
1	PDC6HK**	PPDC6HK	PDC6HK**	PPDC6HK

*Brass
**Aluminum



CANADIAN
STANDARDS
ASSOCIATION*

Complies with the requirements of
ANSI Z21.41B-2010/CSA 6.96-2010.

*CSA design certified, in both the United States and Canada, for natural gas, manufactured gas, propane gas and LP gas-air mixtures at pressures not in excess of 1/2 psig (3.5 kPa).

FLUID TRANSFER
AND HYDRAULIC

PNEUMATIC

SPECIAL APPLICATIONS

DIAGNOSTIC

AGRICULTURE

REFRIGERANT

Flex-Air Series



Eaton's Flex-Air™ fittings are designed to rotate 360 degrees up to a 75° angle. These fittings help to alleviate Carpal Tunnel Syndrome and other stress related injuries in the workplace.

Product Features

- Unique design provides free 360 degree rotation with up to a 75° flex angle in any direction
- Many styles and sizes available
- Prevents kinking of air supply hose

Physical Characteristics

Sizes	Max. Operating Pressure		Min. Burst Pressure	
	(bar)	(psi)	(bar)	(psi)
All sizes	10	145	40	580

Applications & Markets

- General Industry
- Pneumatic Tools



FLUID TRANSFER
AND HYDRAULIC

PNEUMATIC

SPECIAL APPLICATIONS

DIAGNOSTIC

AGRICULTURE

REFRIGERANT

Flex-Air Series

Part Number	Type	Fig.	Connector Ends	ID
FA25F25M	Female to Male	1	1/4" NPT Female & 1/4" NPT Male	0.2" (5 mm)
FA25F37M	Female to Male	2	1/4" NPT Female & 3/8" NPT Male	0.3" (7.5 mm)
FA37F37M	Female to Male	3	3/8" NPT Female & 3/8" NPT Male	0.3" (7.5 mm)
FA37H37M	Hose Barb to Male	4	3/8" Barb & 3/8" NPT Male	0.3" (7.5 mm)
FA25M25M	Male to Male	5	1/4" NPT Male & 1/4" NPT Male	0.2" (5 mm)
FA37M37M	Male to Male	6	3/8" NPT Male & 3/8" NPT Male	0.3" (7.5 mm)
FA25AR25M	ARO to Male	7	ARO 210 Interchange & 1/4" NPT	0.2" (5 mm)
FA25P25M	Industrial Plug to Male	8	1/4" Industrial Interchange & 1/4" NPT Male	0.2" (5 mm)
FA37P25M	Industrial Plug to Male	9	3/8" Industrial Interchange & 1/4" NPT Male	0.3" (7.5 mm)



Figure 1



Figure 5



Figure 8



Figure 2

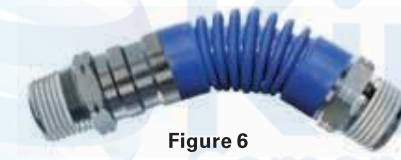

Figure 6



Figure 9



Figure 3



Figure 7



Figure 4

FLUID TRANSFER
AND HYDRAULIC

PNEUMATIC

SPECIAL APPLICATIONS

DIAGNOSTIC

AGRICULTURE

REFRIGERANT

R4000 Series In-Line Check Valves



Eaton's RA4000 Series in-line check valves are designed to allow flow of fluid in one direction only and limit the line's internal pressure (to the cracking pressure). They are rugged and reliable, offer low pressure drop and have elastomer valve seals for leak-free operation.

Product Features

- One-piece zinc plated steel body
- High strength steel valve provides excellent reliability under severe operating conditions
- The valve has a captive nitrile (Buna-N) seal, assuring no leakage at low and high pressures
- Low pressure drop versus flow rate
- Cracking pressure: 7 psi (0.5 bar)
- Cracking pressure is non-adjustable
- Contact Eaton for availability of alternative cracking pressures

Applications & Markets

- Agriculture
- Construction
- Hydraulic Tools
- General Industry
- Fluid Transfer
- Oil and Gas



Flow Data

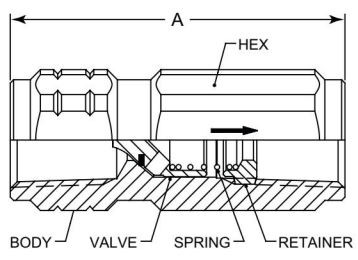
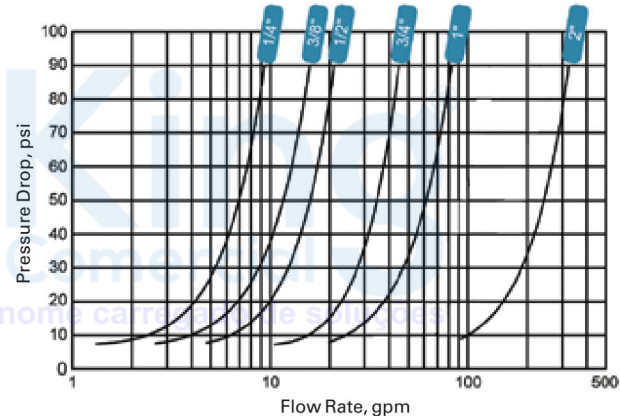

Figure 1

Physical Characteristics

Part Number	Size (in)	Thread NPTF	Fig.	Dimensions		Rated Pressure	
				A (in)	Hex (in)	psi	bar
RA0421000	1/4	1/4-18	1	1.97	0.75	10,150	700
RA0422000	3/8	3/8-18	1	2.36	0.91	10,150	700
RA0423000	1/2	1/2-14	1	2.76	1.06	7,250	500
RA0424000	3/4	3/4-14	1	3.39	1.38	7,250	500
RA0425000	1	1-11 1/2	1	3.94	1.62	7,250	500
RA0429V0*	2	2-11 1/2	1	5.91	2.95	4,350	300

*Supplied with FKM seal.

FS Flow Sensor Series



Eaton's Flow Sensor Series is designed to protect personnel and property in case of hose failure in compliance with Federal Safety Regulations. Flow Sensors are intended for use with compressed air.

FLUID TRANSFER AND HYDRAULIC

PNEUMATIC

SPECIAL APPLICATIONS

DIAGNOSTIC

AGRICULTURE

REFRIGERANT

Product Features

- Automatically shuts off air flow to ruptured hose
- Automatically resets after failure correction
- Compact design, economical, tamper-resistant
- Reduces risk of injury or damage from hose whip
- Operates in any orientation
- Standard body material: Brass

Physical Characteristics

Size	Max. Operating Pressure		Min. Burst Pressure		Rated Flow	
	(bar)	(psi)	(bar)	(psi)	(lpm)	(gpm)
All Sizes	17	250	68	1,000	See Chart	See Chart

Applications & Markets

- General Industry
- Pneumatic Tools

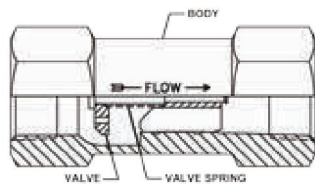
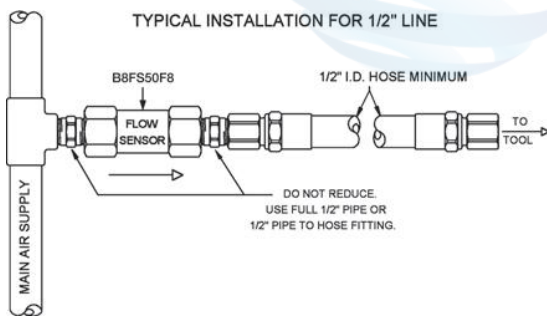

Flow Data

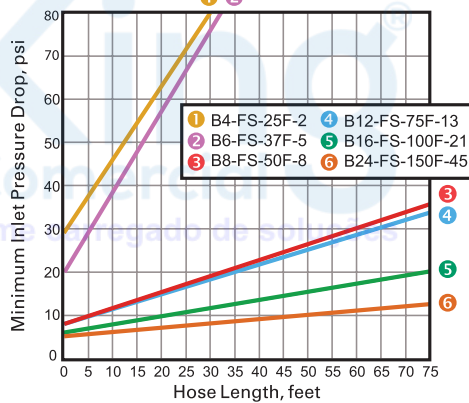

Flow Data: The graph above indicates the minimum inlet pressure for various hose lengths. Each Flow Sensor has a shut-off flow rating dependent upon inlet pressure. The length of hose and fitting size are critical in the proper operation of the valve. For example, with the B8FS50F8 Flow Sensor, the hose I.D. must be 1/2" using only 1/2" pipe thread end fittings. Thirty feet of hose requires at least 20 psig inlet pressure; fifty feet of hose requires at least 28 psig inlet pressure; and seventy-five feet of hose requires at least 36 psig inlet pressure. Inlet pressures lower than those indicated on the curves above will not guarantee protection in case of hose failure. Valve shut-off occurs only when flow exceeds the flow rating for the inlet pressure.

If hose lengths greater than 75 feet are required, a 1/2" size or larger Flow Sensor must be installed on the inlet end of each 75-foot section, and a correspondingly higher inlet pressure must be supplied for proper operation of the Flow Sensor to assure safety.

Part Number*	Body Size	Thread Size	Type	Shut-off Flow, SCFM, at Inlet Pressure, PSIG								Dimensions			
				60	80	100	120	140	160	180	200	(in)	Hex (in)	Length (mm)	Hex (mm)
B4FS25F2	1/4	1/4-18	NPTF	16	18	20	22	23	25	26	27	2.14	0.75	54.36	19.05
B6FS37F5	3/8	3/8-18	NPTF	41	46	50	55	59	63	66	69	2.50	0.88	63.50	22.35
B8FS50F8	1/2	1/2-14	NPTF	65	73	80	87	93	99	104	109	3.12	1.06	79.25	26.92
B12FS75F13	3/4	3/4-14	NPTF	105	118	130	141	152	161	169	177	3.68	1.38	93.47	35.05
B16FS100F21	1	1-11 1/2	NPTF	170	191	210	227	245	260	273	286	4.59	1.75	116.59	44.45
B24FS150F45	1 1/2	1 1/2-11 1/2	NPTF	365	410	450	489	525	557	586	615	5.86	2.50	148.84	63.50

*All flow sensors have a pressure drop of approximately 2 psid at 80% of shut-off flow

FD15 Series Oil Sampling Valve

FLUID TRANSFER
AND HYDRAULIC



Eaton's FD15 Series Oil Sampling Valve is designed for in-line sampling of system fluids without system shutdown, usually in less than one minute, and without fluid contamination.

PNEUMATIC

Product Features

- Standard seal material: Buna-N
- Corrosion resistant plated steel with brass internal components
- Operating Temperature Range: -65°F to +275°F (-53°C to +135°C)
- Minimum Burst Pressure: 12,000 psi
- Minimum Particle Restriction: 500 microns
- Maximum Torque to Operate: 10 in. lbs.
- FD15-1000-04 is qualified to the MIL-V-81940/2-1

Note: This valve is not intended for aerospace applications.

Applications & Markets

- Engine oil
- Lubricating oil
- Transmission fluid and hydraulic fluids in mobile construction equipment, military vehicles, trucks and stationary equipment

SPECIAL APPLICATIONS

Operation

- For best results, Eaton FD15 Oil Sampling Valves should be installed in dynamic fluid lines in low pressure and return lines. If only one sampling point can be chosen, it should be in the return line, upstream of any return line filter. This will insure a representative sample of all components in the fluid system for their present condition.

Instructions

1. Remove metal dustcover on discharge port.
2. Discharge approximately 200 ml of oil to flush valve by turning knurled knob 1/4 turn to the right. Dispose of this sample in the appropriate manner.
3. Locate clean oil sample bottle under discharge port. (Sample bottles are usually supplied by the oil analysis lab.)
4. Turn knurled knob 1/4 turn to the right until bottle is filled to the desired level. The knob can be backed off to throttle the rate of flow.
5. When bottle is filled let go of the knurled knob, the valve will close automatically. Replace metal dustcover wrench tight.

DIAGNOSTIC

Notes

As required in MIL-V-81940/2-1 this valve's flow rate is between 100 and 1500 milliliters per minute at pressures from 0-50 psi. (MIL-V-81940/2-1 applies only to pressures from 50-300 psi.)

The 1/4" NPTF version is qualified to MIL-V-81940/2-1 and its performance is representative of the other inlet port configurations listed above. QPL-81940-9 6-5-89

AGRICULTURE

REFRIGERANT

FD15 Series Oil Sampling Valve

**Male Pipe Thread
50-300 psi**

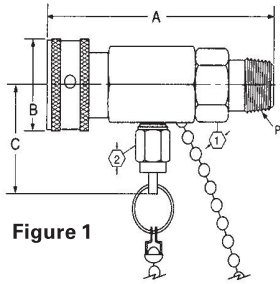

Figure 1

**Male SAE O-Ring Thread
50-300 psi**

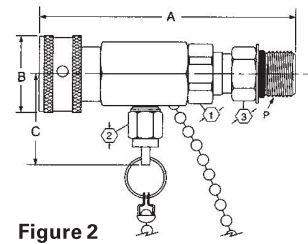

Figure 2

Dimensions (Male Pipe Thread)

Part Number Buna-N	Sampling Type	Port Size	Thread	Type	Fig.	Dimensions			Hex ①		Hex ②		Hex ③	
						A	B	C	mm (in)	mm (in)	mm (in)	mm (in)	mm (in)	mm (in)
FD15-1000-02	50-300 psi	1/8	1/8-27	Male Pipe Thread	1	61.5 (2.42)	25.4 (1.00)	33.0 (1.30)	17.5 (.69)	9.7 (.38)	-	-	-	-
FD15-1000-04	50-300 psi	1/4	1/4-18	Male Pipe Thread	1	65.0 (2.56)	25.4 (1.00)	33.0 (1.30)	17.5 (.69)	9.7 (.38)	-	-	-	-

Dimensions (Male SAE O-Ring Thread)

Part Number Buna-N	Sampling Type	Port Size	Thread	Type	Fig.	Dimensions			Hex ①		Hex ②		Hex ③	
						A	B	C	mm (in)	mm (in)	mm (in)	mm (in)	mm (in)	mm (in)
FD15-1002-04	50-300 psi	7/16	7/16-20	Male SAE O-Ring Thread	2	70.9 (2.79)	25.4 (1.00)	33.0 (1.30)	17.5 (.69)	9.7 (.38)	14.2 (.56)	-	-	

Dimensions (Male Pipe Thread)

Part Number Buna-N	Sampling Type	Port Size	Thread	Type	Fig.	Dimensions			Hex ①		Hex ②		Hex ③	
						A	B	C	mm (in)	mm (in)	mm (in)	mm (in)	mm (in)	mm (in)
FD15-1026-04	0-50 psi	1/4	1/4-18	Male Pipe Thread	3	65.0 (2.56)	25.4 (1.00)	33.0 (1.30)	17.5 (.69)	9.7 (.38)	-	-	-	

Dimensions Male SAE O-Ring Thread)

Part Number Buna-N	Sampling Type	Port Size	Thread	Type	Fig.	Dimensions			Hex ①		Hex ②		Hex ③	
						A	B	C	mm (in)	mm (in)	mm (in)	mm (in)	mm (in)	mm (in)
FD15-1025-04	0-50 psi	7/16	7/16-20	Male SAE O-Ring Thread	4	70.9 (2.79)	25.4 (1.00)	33.0 (1.30)	17.5 (.69)	9.7 (.38)	14.2 (.56)	-	-	

**Male Pipe Thread
0-50 psi**

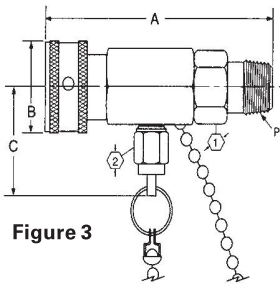

Figure 3

**Male SAE O-Ring Thread
0-50 psi**

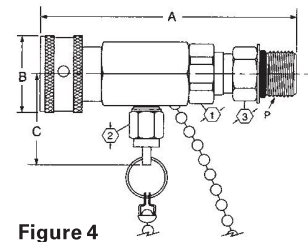

Figure 4

FLUID TRANSFER
AND HYDRAULIC

PNEUMATIC

SPECIAL APPLICATIONS

DIAGNOSTIC

AGRICULTURE

REFRIGERANT

FD90 Series Diagnostic Coupling SAE J1502 Interchange



Eaton's FD90 Series diagnostic coupling is designed to connect and disconnect pressure gauges to hydraulic systems, eliminating the need for permanent gauges. The maximum operating pressure is 7,000 psi.

Product Features

- Automatic sleeve for one hand push-to-connect operation
- Flush face valving provides minimal fluid loss and low air inclusion
- Self-sealing valve design allows connection and disconnection at 500 psi
- Broad range of end configurations for system accessibility
- Standard seal material: Buna-N

- Diagnostic pressure testing for hydraulic systems
- Standard seal material: High resistance carbon steel with zinc trivalent plating

Applications & Markets

Physical Characteristics

Coupling Body Size (in)	Max. Operating Pressure		Min. Burst Pressure Connected		Vacuum Connected Only (in./Hg)	Rated Flow		Air Inclusion cc. max.	Fluid Loss cc.max.
	(bar)	(psi)	(bar)	(psi)		(lpm)	(gpm)		
1/4	483	7,000	1,931	28,000	28	1.89	0.6	0.02	0.10

Dimensions (Female Pipe, Valved)

Part Number Buna-N	Part Number with Dust Cap Buna-N	Coupling Type	Body Size	Port Size	Thread	Type	Fig.	Dimensions				Hex ^①			
								A		B					
								mm	(in)	mm	(in)	mm	(in)		
FD90-1034-02-04	FD90-1035-02-04	Plug/Male	1/4	1/8	1/8 - 27	Female NPT	1	43.2	(1.70)	-	-	15.7	(0.62)		
FD90-1021-02-04	—	Socket/Female	1/4	1/8	1/8 - 27	Female NPT	2	49.5	(1.95)	25.4	(1.00)	19.1	(0.75)		
FD90-1034-04-04	FD90-1035-04-04	Plug/Male	1/4	1/4	1/4 - 18	Female NPT	1	48.3	(1.90)	-	-	19.1	(0.75)		
FD90-1021-04-04	—	Socket/Female	1/4	1/4	1/4 - 18	Female NPT	2	57.2	(2.25)	25.4	(1.00)	19.1	(0.75)		

Dimensions (Male SAE O-Ring, Valved)

Part Number Buna-N	Part Number with Dust Cap Buna-N	Coupling Type	Body Size	Port Size	Thread	Type	Fig.	Dimensions				Hex ^①			
								A		B					
								mm	(in)	mm	(in)	mm	(in)		
FD90-1044-03-04	FD90-1004-03-04	Plug/Male	1/4	3/8	3/8 - 24	Male SAE O-Ring	3	38.6	(1.52)	-	-	15.7	(0.62)		
FD90-1044-04-04	FD90-1004-04-04	Plug/Male	1/4	7/16	7/16 - 20	Male SAE O-Ring	3	40.1	(1.58)	-	-	15.7	(0.62)		
FD90-1044-05-04	FD90-1004-05-04	Plug/Male	1/4	1/2	1/2 - 20	Male SAE O-Ring	3	33.5	(1.32)	-	-	15.7	(0.62)		
FD90-1044-06-04	FD90-1004-06-04	Plug/Male	1/4	9/16	9/16 - 18	Male SAE O-Ring	3	33.5	(1.32)	-	-	17.5	(0.69)		

Dimensions (Male Pipe, Valved)

Part Number Buna-N	Part Number with Dust Cap Buna-N	Coupling Type	Body Size	Port Size	Thread	Type	Fig.	Dimensions				Hex ^①			
								A		B					
								mm	(in)	mm	(in)	mm	(in)		
FD90-1012-02-04	FD90-1045-02-04	Plug/Male	1/4	1/8	1/8 - 27	Male NPT	4	40.6	(1.60)	-	-	15.7	(0.62)		
FD90-1012-04-04	FD90-1045-04-04	Plug/Male	1/4	1/4	1/4 - 18	Male NPT	4	37.8	(1.49)	-	-	17.5	(0.69)		

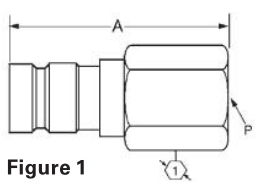

Figure 1

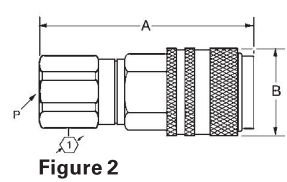

Figure 2

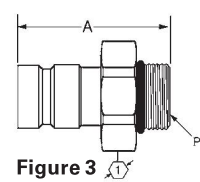

Figure 3

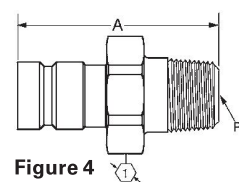

Figure 4

FD90 Series

Diagnostic Coupling

SAE J1502 Interchange

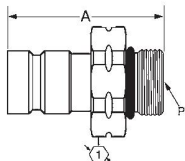

Figure 5

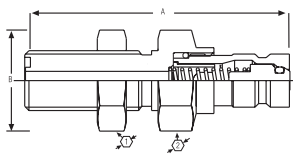

Figure 6

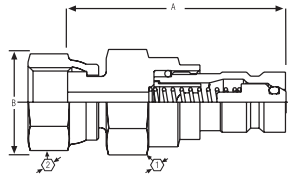

Figure 7

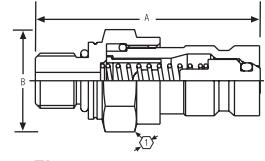

Figure 8

Dimensions (Metric Male O-Ring, Valved)

Part Number Buna-N	Part Number with Dust Cap Buna-N	Coupling Type	Body Size	Port Size	Thread	Type	Fig.	Dimensions		Hex ①			
								A	B				
								mm	(in)	mm	(in)	mm	(in)
FD90-1046-06-04	FD90-1047-06-04	Plug/Male	1/4	M14	M14x1.5	Male O-Ring	5	38.5	(1.52)	-	-	19.1	(0.75)

Dimensions (Female SAE O-Ring, Valved)

Part Number Buna-N	Coupling Type	Body Size	Port Size	Thread	Type	Fig.	Dimensions		Hex ①				
							A	B					
								mm	(in)	mm	(in)	mm	(in)
FD90-1041-04-04	Socket/Female	1/4	7/16	7/16 - 20	Female SAE O-Ring	2	55.9	(2.20)	25.40	(1.00)	19.1	(0.75)	

Dimensions (Male ORS Bulkhead, Valved)

Part Number Buna-N	Coupling Type	Body Size	Port Size	Thread	Type	Fig.	Dimensions		Hex ①				
							A	B					
								mm	(in)	mm	(in)	mm	(in)
FD90-1206-04-04	Plug/Male	1/4	9/16	9/16 - 18	Male ORS Bulkhead	6	62.5	(2.46)	20.6	(0.81)	20.6	(0.81)	

Dimensions (Male ORS Bulkhead, Valved)

Part Number Buna-N	Coupling Type	Body Size	Port Size	Thread	Type	Fig.	Dimensions		Hex ①				
							A	B					
								mm	(in)	mm	(in)	mm	(in)
FD90-1061-04-04	Plug/Male	1/4	9/16	9/16 - 18	Female ORS Swivel	7	46.5	(1.79)	22.1	(0.87)	17.5	(0.69)	
FD90-1061-06-04	Plug/Male	1/4	11/16	11/16 - 16	Female ORS Swivel	7	46.5	(1.83)	23.9	(0.94)	20.6	(0.81)	
FD90-1061-08-04	Plug/Male	1/4	13/16	13/16 - 16	Female ORS Swivel	7	49.0	(1.93)	27.4	(1.08)	23.9	(0.94)	

Dimensions (Male Metric O-Ring, Valved)

Part Number Buna-N	Coupling Type	Body Size	Port Size	Thread	Type	Fig.	Dimensions		Hex ①				
							A	B					
								mm	(in)	mm	(in)	mm	(in)
FD90-1090-10-04	Plug/Male	1/4	M10	M10x1	Mertic O-Ring	8	40.1	(1.58)	18.3	(0.72)	—	—	

Dust Cap for Plug/Male Halves

Body Size	Part Number
1/4	FD90-1040-04



Dust Cap for
Plug/Male Halves

FLUID TRANSFER
AND HYDRAULIC

PNEUMATIC

SPECIAL APPLICATIONS

DIAGNOSTIC

AGRICULTURE

REFRIGERANT

Pressure Gauge Kit FF14802



Eaton's Pressure Gauge Kit and screw together test couplings provide accurate and efficient pressure control and monitoring of your hydraulic system, while minimizing the introduction of contamination. The complete kit is pre-packaged with Eaton's most common adapters and test couplings.

Product Features

- Test system at working pressure
- 630 bar (9,000 psi) working pressure
- 345 bar (5,000 psi) connect under pressure
- Accurate pressure control and system monitoring
- Leak-free connection before piston valve opens

Couplings/Adapters

- Standard body material: Zinc Nickel Plated Steel
- Standard seal material: FKM
- 345 bar (5,000 psi) connect under pressure
- 630 bar (9,000 psi) working pressure

Hose Assemblies

- 630 bar (9,000 psi) working pressure
- 20mm (.75") bend radius
- Nominal Bore 2mm (.08")
- Hose cover/core – PA 11/12
- Reinforcement – synthetic fiber

Gauges

- Polished Brass Casing
- Glycerine Filled
- Dual Scales
- Relief Valve
- Acrylic Lens

Applications & Markets

- Hydraulics and mineral based fluids
- Agricultural equipment
- Construction equipment
- On-Highway vehicles
- Industrial equipment

Pressure Gauge Kit

Complete Kit Number	Component Part Number	Description	Quantity Per Kit
FF14802	FF14783	1/8" NPT Test Coupling	2
	FF14784	1/4" NPT Test Coupling	2
	FF14787	7/16-20 UNF Test Coupling	1
	FF14788	9/16-18 UNF Test Coupling	1
	FF14794	1/4" NPT Gauge Adapter	3

Complete Kit Number	Component Part Number	Description	Quantity Per Kit
	FF14796	Union Adapter	2
	FF14798	60" Test Hose Assembly	2
	FF14799	(-) 30 in/Hg - 30 psi Gauge	1
	FF14800	1,000 psi Gauge	1
	FF14801	7,500 psi Gauge	1

Dimensions (Standard Test Couplings)

Part Number	Thread	Dimensions				Hex 		Bag Quantity*
		A mm	(in)	B mm	(in)	mm	(in)	
FF14783	1/8" NPT	45.0	(1.77)	20.0	(.79)	17.0	(.67)	4
FF14784	1/4" NPT	50.0	(1.97)	20.0	(.79)	17.0	(.67)	4
FF14785	M14	49.0	(1.93)	20.0	(.79)	19.0	(.75)	3
FF14786	M16	48.5	(1.91)	20.0	(.79)	22.0	(.87)	3
FF14787	7/16-20 UNF	47.0	(1.85)	20.0	(.79)	17.0	(.67)	4
FF14788	9/16-18 UNF	47.5	(1.87)	20.0	(.79)	19.0	(.75)	4

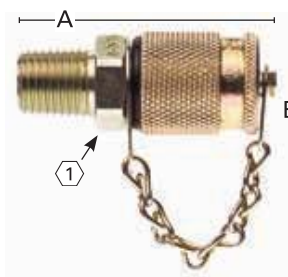

Standard Test Couplings

*When the indicated part number is ordered, the bag quantity is the number of pieces supplied. For example, if a quantity of one FF14792 is ordered, one bag containing two pieces will be delivered.

Dimensions (Bulkhead Couplings)

Part Number	Thread	Dimensions				Hex ①		Hex ②		Bag Quantity*
		A		B		mm	(in)	mm	(in)	
FF14789	M16	72.0	2.83	20.0	.79	17.0	.67	19.0	.75	2

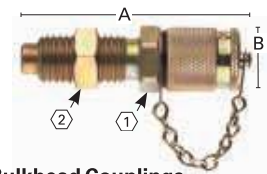

Bulkhead Couplings

Dimensions (Swivel Run Tee with Test Coupling)

Part Number	Thread #1	Thread #2	Dimensions				Hex ①		Bag Quantity*
			A		B		mm	(in)	
FF14790	7/16-20 UNF	7/16-20 UNF	47.7	(1.88)	20.0	(.79)	27.0	(1.06)	2
FF14791	9/16-18 UNF	9/16-18 UNF	47.7	(1.88)	20.0	(.79)	27.0	(1.06)	2
FF14792	3/4-16 UNF	3/4-16 UNF	47.7	(1.88)	20.0	(.79)	27.0	(1.06)	2

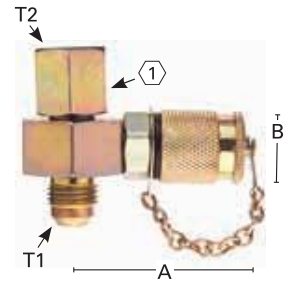

Swivel Run Tee with Test Coupling

Dimensions (Gauge Adapter)

Part Number	Thread #1	Thread #2	Dimensions				Hex ①		Hex ②		Bag Quantity*
			A		B		mm	(in)	mm	(in)	
FF14793	1/4" NPT	M16	54.0	(2.13)	19.0	(.75)	19.0	(.75)	2		

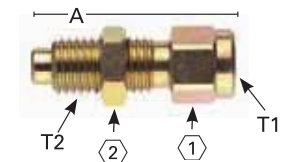

Gauge Adapter

Dimensions (Direct Gauge Adapter)

Part Number	Thread	Dimensions				Hex ①		Bag Quantity*
		A		B		mm	(in)	
FF14794	1/4" NPT	40.5	(1.59)	20.0	(.79)	19.0	(.75)	2
FF14795	7/16-20 UNF	41.0	(1.61)	20.0	(.79)	19.0	(.75)	2

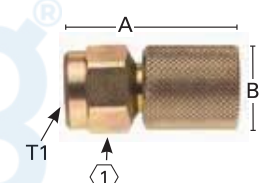

Direct Gauge Adapter

Dimensions (Union Adapter)

Part Number	Thread #1	Thread #2	Dimensions				Bag Quantity*
			A		Hex ①		
FF14796	M16	M16	42.5	(1.67)	17.0	(.67)	2

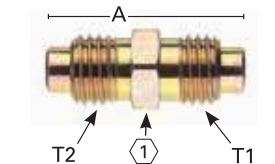

Union Adapter

Dimensions (Test Hose Assembly)

Part Number	Thread	Dimensions				Bag Quantity*
		Cut Length		Overall Length		
		mm	(in)	mm	(in)	
FF14797	M16	872.0	(34.33)	914.4	(36.00)	1
FF14798	M16	1482.0	(58.35)	1524.0	(60.00)	1



Test Hose Assembly

Dimensions (Gauges)

Part Number	Thread	Dimensions				Rating	Bag Quantity*
		A		B			
FF14799	1/4" NPT	65.3	(2.57)	53.3	(2.10)	(-)30 in/Hg - 30 psi	1
FF14800	1/4" NPT	65.3	(2.57)	53.3	(2.10)	0 - 1,000 psi	1
FF14801	1/4" NPT	65.3	(2.57)	53.3	(2.10)	0 - 7,500 psi	1

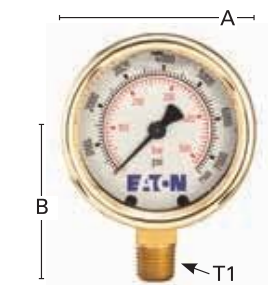

Gauges

FLUID TRANSFER
AND HYDRAULIC

PNEUMATIC

SPECIAL APPLICATIONS

DIAGNOSTIC

AGRICULTURE

REFRIGERANT

FD48 Series Parker Bruning SM-250 Interchange



Eaton's FD48 Series coupling is poppet style quick disconnect coupling designed to interchange with Parker Bruning SM-250 couplings where excellent high and low pressure sealing is required. The FD48 operates with pressures up to 3,000 psi.

Product Features

- Self-sealing poppet valves provide excellent high and low pressure sealing
- PUSH-PULL™ ball latch design allows quick and easy connection and disconnection of fluid lines
- Heat-treated and plated steel for wear and corrosion resistance
- Standard seal material: Buna-N
- Standard seal material: High resistance carbon steel with zinc trivalent plating

Applications & Markets

- Hydraulic and fluid transfer
- Agricultural equipment

Physical Characteristics

Body Size (in)	Max. Operating Pressure		Min. Burst Pressure Connected		Vacuum Connected Only	Rated Flow		Air Inclusion	Fluid Loss
	(bar)	(psi)	(bar)	(psi)	(in./Hg)	(lpm)	(gpm)	cc. max.	cc.max.
1/4	210	3,000	840	12,000	28	11	3	.50	1.10

Dimensions (Female NPT, Valved)

Part Number Buna-N	Coupling Type	Body Size	Port Size	Thread	Type	Fig.	Dimensions					
							A	B		Hex Ⓢ		
							mm	(in)	mm	(in)	mm	(in)
FD48-1002-04-04	Plug/Male	1/4	1/4	1/4-18	Female NPT	1	36.8	(1.45)	-	-	19.0	(.75)
FD48-1001-04-04	Socket/Female	1/4	1/4	1/4-18	Female NPT	2	51.1	(2.01)	26.9	(1.06)	20.6	(.81)

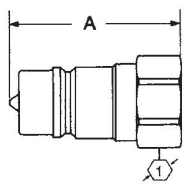

Figure 1

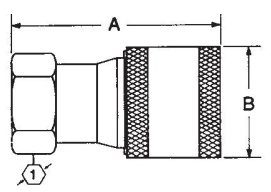
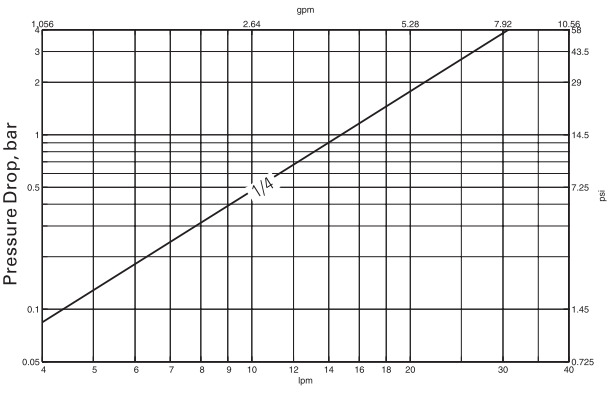

Figure 2

Flow Data

Pressure Drop Versus Flow Graph



Dust Cap/Plug

Part Number (Buna-N)	Body Size
FD48-1042-04*	1/4



Dust Cap/Plug

*Fits both plug/male and socket/female halves

FD72/FD76 Series Connect Under Pressure — Farm ISO 5675 Interchange



Eaton's FD72 Series coupling incorporates special valving allowing connection to a FD76 Series male half under pressure. The maximum operating pressure is 3,000 psi. Contains an over travel, self-sealing poppet valve construction for connecting to a pressurized male tip. Applications require that the tractor control valve be actuated to open the flow path and to equalize the pressure.

Product Features

- Push-to-connect for one-hand operation when sleeve is mounted
- Interchanges with ISO 5675 plug/male tips
- Retaining ring groove on socket/female half for bulkhead and breakaway frame mounting

Applications & Markets

- Standard seal material: Buna-N
- Standard body material: High resistance carbon steel with zinc trivalent plating
- Hydraulic fluid transfer
- Agricultural equipment

Physical Characteristics

Body Size (in)	Max. Operating Pressure		Min. Burst Pressure Connected		Vacuum Connected Only	Rated Flow		Air Inclusion	Fluid Loss
	(bar)	(psi)	(bar)	(psi)	(in./Hg)	(lpm)	(gpm)	cc. max.	cc.max.
5/8	207	3,000	827	12,000	28	61	16	2.8	2.8

Dimensions (Female NPT, Valved)

Part Number Buna-N	Coupling Type	Body Size	Port Size	Thread	Type	Dimensions									
						Fig. A	B	C	D	E	Hex ^①				
						mm	(in)	mm	(in)	mm	(in)	mm	(in)	mm	(in)
FD76-1002-08-10	Plug/Male	5/8	1/2	1/2-14	Female Pipe	1	52.1 (2.05)	—	—	—	—	—	—	26.9	(1.06)
FD72-1001-08-10	Socket/Female	5/8	1/2	1/2-14	Female Pipe	2	80.5 (3.17)	38.6 (1.52)	38.1 (1.50)	35.8 (1.41)	5.1 (0.20)	25.4	(1.00)		
FD76-1010-08-10	Plug/Male	5/8	1/2	3/4-16	Female SAE O-Ring	3	52.1 (2.05)	—	—	—	—	—	—	270	(1.06)

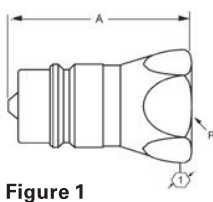

Figure 1

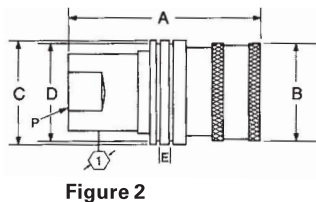

Figure 2

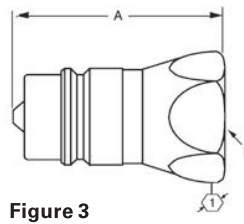

Figure 3

Dust Cap

Part Number Buna-N	Body Size
5657-10	5/8



Dust Cap

Dust Plug

Part Number Buna-N	Body Size
5659-10	5/8



Dust Plug

Break Away Frame

Part Number Buna-N	Body Size
5603	5/8



Break Away Frame

Flow Data

Pressure Drop Versus Flow Graph

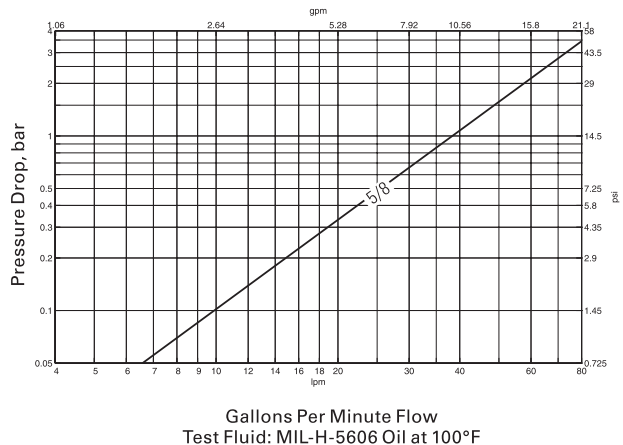

5400 Series Low Air Inclusion Refrigerant



Eaton's 5400 Series low air inclusion product line is designed for air conditioning, refrigerant, gaseous and fluid transfer applications.

Product Features

- Brazed or threaded end connections for versatility of installation on tubing or hose
- Tubular valve construction for low fluid loss and air inclusion
- Thread together design allows connection and disconnection against pressure
- Lock washer and jam nut standard for optional bulkhead mounting
- Standard seal material: Neoprene
- Guardian Seal™ plating for excellent corrosion resistance

Physical Characteristics

Coupling Size (in)	Max. Operating Pressure Connected		Min. Burst Pressure Connected		Max. Operating Pressure Disconnected				Vacuum Connected Only (in./Hg)	Rated Flow		Air Inclusion Loss cc. max.	Fluid Loss cc. max.
	(bar)	(psi)	(bar)	(psi)	Male Half (bar)	Female Half (psi)	(bar)	(psi)		(lpm)	(gpm)		
1/4	207	3,000	621	9,000	172	2,500	34	500	28	8	2	.10	.05
1/2	121	1,750	359	5,200	121	1,750	28	400	28	53	14	.10	.10
3/4	48	700	145	2,100	55	800	28	400	28	132	35	.30	.10
1	48	700	145	2,100	48	700	21	300	28	284	75	.50	.20

Applications & Markets

- Mobile air conditioning and refrigerant

Flow Data

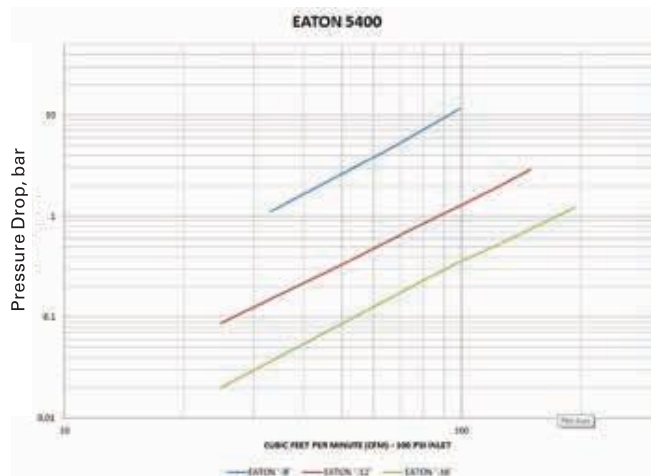

5400 Series Low Air Inclusion Refrigerant

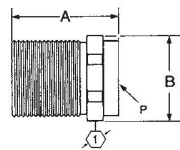

Figure 1

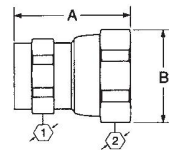

Figure 2

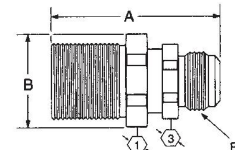

Figure 3

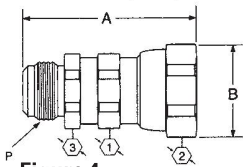

Figure 4

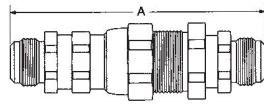

Figure 5

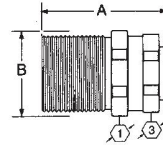

Figure 6

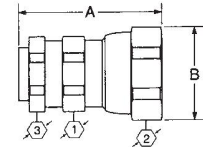

Figure 7

Dimensions – No Adapter

Part Number	Coupling Type	Body Size	Type	Fig.	Dimensions		Hex ①		Hex ②		Hex ③			
					A	B	mm	(in)	mm	(in)	mm	(in)	mm	(in)
5400-S2-4	Male	1/4	No Adapter	1	27.4	(1.08)	21.1	(.83)	19.1	(.75)	-	-	-	-
5400-S5-4	Female	1/4	No Adapter	2	28.7	(1.13)	21.1	(.83)	16.0	(.63)	19.1	(.75)	-	-
5400-S2-8	Male	1/2	No Adapter	1	34.8	(1.37)	32.0	(1.26)	29.0	(1.14)	-	-	-	-
5400-S5-8	Female	1/2	No Adapter	2	40.6	(1.60)	33.0	(1.30)	26.0	(1.02)	30.0	(1.18)	-	-
5400-S2-12	Male	3/4	No Adapter	1	44.2	(1.74)	46.4	(1.83)	41.0	(1.64)	-	-	-	-
5400-S5-12	Female	3/4	No Adapter	2	55.1	(2.17)	45.0	(1.77)	35.0	(1.38)	41.0	(1.61)	-	-
5400-S2-16	Male	1	No Adapter	1	46.5	(1.83)	53.0	(2.10)	48.0	(1.89)	-	-	-	-
5400-S5-16	Female	1	No Adapter	2	61.1	(2.41)	56.0	(2.20)	45.0	(1.77)	50.0	(1.97)	-	-

Dimensions – SAE 37° (JIC)

Part Number	Coupling Type	Body Size	Port Size	Thread	Type	Fig.	Dimensions		Hex ①		Hex ②		Hex ③			
							A	B	mm	(in)	mm	(in)	mm	(in)	mm	(in)
*Couplings must be ordered by components as shown on page 150.							mm	(in)	mm	(in)	mm	(in)	mm	(in)		
5410-S17-4-4*	Male	1/4	7/16	7/16-20	SAE 37° (JIC)	3	47.8	(1.88)	21.1	(.83)	19.1	(.75)	-	-	16.0	(.63)
5410-S14-4-4*	Female	1/4	7/16	7/16-20	SAE 37° (JIC)	4	49.0	(1.93)	21.1	(.83)	16.0	(.63)	19.1	(.75)	15.7	(.62)
5410-4-4*	Complete	1/4	7/16	7/16-20	SAE 37° (JIC)	5	89.9	(3.54)	-	-	-	-	-	-	-	
5410-S17-6-4*	Male	1/4	9/16	9/16-18	SAE 37° (JIC)	3	48.0	(1.89)	21.1	(.83)	19.1	(.75)	-	-	16.0	(.63)
5410-S14-6-4*	Female	1/4	9/16	9/16-18	SAE 37° (JIC)	4	49.3	(1.94)	21.1	(.83)	16.0	(.63)	19.1	(.75)	15.7	(.62)
5410-6-4*	Complete	1/4	9/16	9/16-18	SAE 37° (JIC)	5	90.4	(3.56)	-	-	-	-	-	-	-	
5410-S17-6-8*	Male	1/2	9/16	9/16-18	SAE 37° (JIC)	3	55.4	(2.18)	31.8	(1.25)	28.7	(1.13)	-	-	25.4	(1.00)
5410-S14-6-8*	Female	1/2	9/16	9/16-18	SAE 37° (JIC)	4	61.7	(2.43)	33.3	(1.31)	25.4	(1.00)	30.2	(1.19)	25.4	(1.00)
5410-6-8*	Complete	1/2	9/16	9/16-18	SAE 37° (JIC)	5	107.4	(4.23)	-	-	-	-	-	-	-	
5410-S17-8-8*	Male	1/2	3/4	3/4-16	SAE 37° (JIC)	3	57.9	(2.28)	31.8	(1.25)	28.7	(1.13)	-	-	25.4	(1.00)
5410-S14-8-8*	Female	1/2	3/4	3/4-16	SAE 37° (JIC)	4	64.3	(2.53)	33.3	(1.31)	25.4	(1.00)	30.2	(1.19)	25.4	(1.00)
5410-8-8*	Complete	1/2	3/4	3/4-16	SAE 37° (JIC)	5	112.8	(4.44)	-	-	-	-	-	-	-	
5410-S17-10-12*	Male	3/4	7/8	7/8-14	SAE 37° (JIC)	3	69.9	(2.75)	46.5	(1.83)	41.4	(1.63)	-	-	35.1	(1.38)
5410-S14-10-12*	Female	3/4	7/8	7/8-14	SAE 37° (JIC)	4	80.3	(3.16)	45.7	(1.80)	35.1	(1.38)	41.1	(1.62)	35.1	(1.38)
5410-10-12*	Complete	3/4	7/8	7/8-14	SAE 37° (JIC)	5	135.4	(5.33)	-	-	-	-	-	-	-	
5410-S17-12-12*	Male	3/4	1 1/16	1 1/16-12	SAE 37° (JIC)	3	72.6	(2.86)	46.5	(1.83)	41.4	(1.63)	-	-	35.1	(1.38)
5410-S14-12-12*	Female	3/4	1 1/16	1 1/16-12	SAE 37° (JIC)	4	83.1	(3.27)	45.7	(1.80)	35.1	(1.38)	41.1	(1.62)	35.1	(1.38)
5410-12-12*	Complete	3/4	1 1/16	1 1/16-12	SAE 37° (JIC)	5	140.7	(5.54)	-	-	-	-	-	-	-	
5410-S17-16-16*	Male	1	1 5/16	1 5/16-12	SAE 37° (JIC)	3	75.9	(2.99)	53.3	(2.10)	47.8	(1.88)	-	-	44.5	(1.75)
5410-S14-16-16*	Female	1	1 5/16	1 5/16-12	SAE 37° (JIC)	4	89.7	(3.53)	56.9	(2.24)	44.5	(1.75)	50.8	(2.00)	44.5	(1.75)
5410-16-16*	Complete	1	1 5/16	1 5/16-12	SAE 37° (JIC)	5	149.6	(5.89)	-	-	-	-	-	-	-	

FLUID TRANSFER
AND HYDRAULIC

PNEUMATIC

SPECIAL APPLICATIONS

DIAGNOSTIC

AGRICULTURE

REFRIGERANT

5400 Series Low Air Inclusion Refrigerant

FLUID TRANSFER
AND HYDRAULIC

Dimensions – Braze Tubing Adapter

Part Number Neoprene	Coupling Type	Body Size	Tube O.D. Size	Type	Fig.	Dimensions									
						A		B		Hex ①		Hex ②		Hex ③	
*Couplings must be ordered by components as shown on page 150.						mm	(in)	mm	(in)	mm	(in)	mm	(in)	mm	(in)
5401-S17-4-4*	Male	1/4	1/4	Braze Tubing Adapter	6	38.6	(1.52)	21.1	(.83)	19.1	(.75)	-	-	16.0	(.63)
5401-S14-4-4*	Female	1/4	1/4	Braze Tubing Adapter	7	39.9	(1.57)	21.1	(.83)	16.0	(.63)	19.1	(.75)	16.0	(.63)
5401-S17-6-4*	Male	1/4	3/8	Braze Tubing Adapter	6	38.6	(1.52)	21.1	(.83)	19.1	(.75)	-	-	16.0	(.63)
5401-S14-6-4*	Female	1/4	3/8	Braze Tubing Adapter	7	39.9	(1.57)	21.1	(.83)	16.0	(.63)	19.1	(.75)	16.0	(.63)
5410-S17-6-8*	Male	1/2	3/8	Braze Tubing Adapter	6	44.5	(1.75)	33.3	(1.31)	28.7	(1.13)	-	-	25.4	(1.00)
5401-S14-6-8*	Female	1/2	3/8	Braze Tubing Adapter	7	50.8	(2.00)	33.3	(1.31)	25.4	(1.00)	30.2	(1.19)	25.4	(1.00)
5401-S17-8-8*	Male	1/2	1/2	Braze Tubing Adapter	6	44.5	(1.75)	33.3	(1.31)	28.7	(1.13)	-	-	25.4	(1.00)
5401-S14-8-8*	Female	1/2	1/2	Braze Tubing Adapter	7	50.8	(2.00)	33.3	(1.31)	25.4	(1.00)	30.2	(1.19)	25.4	(1.00)
5401-S17-10-12*	Male	3/4	5/8	Braze Tubing Adapter	6	62.7	(2.47)	45.7	(1.80)	41.4	(1.63)	-	-	35.1	(1.38)
5401-S14-10-12*	Female	3/4	5/8	Braze Tubing Adapter	7	73.2	(2.88)	45.7	(1.80)	35.1	(1.38)	41.4	(1.63)	35.1	(1.38)
5401-S17-12-12*	Male	3/4	3/4	Braze Tubing Adapter	6	62.7	(2.47)	45.7	(1.80)	41.4	(1.63)	-	-	35.1	(1.38)
5401-S14-12-12*	Female	3/4	3/4	Braze Tubing Adapter	7	73.2	(2.88)	45.7	(1.80)	35.1	(1.38)	41.4	(1.63)	35.1	(1.38)
5401-S17-16-16*	Male	1	1	Braze Tubing Adapter	6	71.1	(2.80)	56.9	(2.24)	47.8	(1.88)	-	-	44.5	(1.75)
5401-S14-16-16*	Female	1	1	Braze Tubing Adapter	7	84.8	(3.34)	56.9	(2.24)	44.5	(1.75)	50.8	(2.00)	44.5	(1.75)

PNEUMATIC

Dust Caps and Dust Plugs

Dust Cap with Gasket	Dust Plug with Gasket	Body Size
5400-S6-4	5400-S8-4	1/4
5400-S6-8	5400-S8-8	-1/2
5400-S6-12	5400-S8-12	3/4
5400-S6-16	5400-S8-16	1

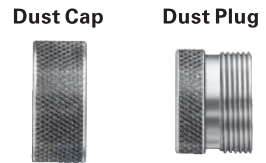

Adapter SAE 37° (JIC)

O-Ring	Brass	Steel	Body Size	Thread	Tube O.D. Size
22546-12	202220-4-4B	202220-4-4S	1/4	7/16-20	1/4
22546-12	202220-6-4B	202220-6-4S	1/4	9/16-18	3/8
22546-17	-	202220-6-8S	1/2	9/16-18	3/8
22546-17	202220-8-8B	202220-8-8S	1/2	3/4-16	1/2
22546-23	-	202220-10-12S	3/4	7/8-14	5/8
22546-23	-	202220-12-12S	3/4	1 1/16-12	3/4
22546-28	-	202220-16-16S	3/4	1 3/16-12	1

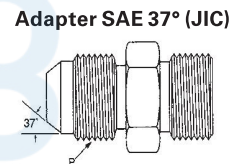

SPECIAL APPLICATIONS

Adapter – Braze

O-Ring	Brass	Steel	Body Size	Thread	Tube O.D. Size
22546-12	202208-4-4B	-	1/4	1/2-20	1/4
22546-17	202208-4-8B	-	1/2	7/8-20	1/4
22546-12	202208-6-4B	-	1/4	1/2-20	3/8
22546-17	202208-6-8B	-	1/2	7/8-20	3/8
22546-17	202208-8-8B	-	1/2	7/8-20	1/2
2254617	202208-10-8B	202208-10-8S	1/2	7/8-20	5/8
22546-23	202208-10-12B	202208-10-12S	3/4	1 1/4-18	5/8
22546-23	202208-12-12B	-	3/4	1 1/4-18	3/4
22546-23	202208-14-12B	-	3/4	1 1/4-18	7/8
22546-28	202208-14-16B	-	1	1 19/32-20	7/8
22546-28	202208-16-16B	-	1	1 19/32-20	1
22546-28	202208-18-16B	-	1	1 19/32-20	1 1/8
22546-28	202208-20-16B	-	1	1 19/32-20	1 3/16
22546-28	202208-22-16B	-	1	1 19/32-20	1 1/4

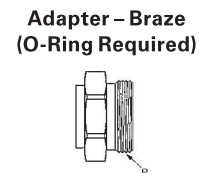

DIAGNOSTIC

Hose Fitting SAE 100R5†

O-Ring	Fitting Assembly	Body Size	Hose Size	Thread	Dimensions D	
					mm	(in)
22546-12	487-4-4S	1/4	-4	1/2-20	23.4	(.92)
22546-12	487-4-6S	1/4	-6	1/2-20	24.4	(.96)
22546-17	487-8-6S	1/2	-6	7/8-20	24.4	(.96)
22546-17	487-8-8S	1/2	-8	7/8-20	26.9	(1.06)
22546-23	487-12-10S	3/4	-10	1 1/4-18	27.2	(1.07)
22546-23	487-12-12S	3/4	-12	1 1/4-18	27.2	(1.07)
22546-28	487-16-16S	1	-16	1 19/32-20	25.7	(1.01)

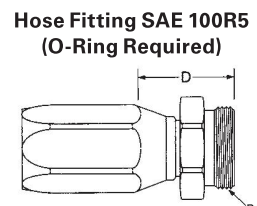

AGRICULTURE

REFRIGERANT

†Additional dash styles available.

5400 Series

Low Air Inclusion Refrigerant

For assemblies, order by components as shown by base number and dash (-) size below. Example, if a 5401-S14-10-12 is required, order as components, (1) 5400-S5-12, (1) 202208-10-12B Adapter and (1) 22546-23 O-Ring.

Assembly Part Number	5400-S2 Male Half	Quantity	5400-S5 Female Half	Quantity	202208-Brass Braze-On Adapter	Quantity	202220-Steel 37° SAE Adapter	Quantity	22546 O-Ring	Quantity
5401-S14-10-12			-12	1	-10 -12B	1			-23	1
5401-S14-10-8			-8	1	-10 -8B				-17	1
5401-S14-12-12			-12	1	-12 -12B	1			-23	1
5401-S14-16-16			-16	1	-16 -16B	1			-28	1
5401-S14-4-4			-4	1	-4 -4B	1			-12	1
5401-S14-6-4			-4	1	-6 -4B	1			-12	1
5401-S14-6-8			-8	1	-6 -8B	1			-17	1
5401-S14-8-8			-8	1	-8 -8B	1			-17	1
5401-S17-10-12	-12	1			-10 -12B	1			-23	1
5401-S17-10-8	-8	1			-10 -8B	1			-17	1
5401-S17-12-12	-12	1			-12 -12	1			-23	1
5401-S17-14-16	-16	1			-16 -16	1			-28	1
5401-S17-4-4	-4	1			-4 -4B	1			-17	1
5401-S17-6-4	-4	1			-6 -4B	1			-12	1
5401-S17-6-8	-8	1			-6 -8B	1			-17	1
5401-S17-8-8	-8	1			-8 -8B	1			-17	1
5410-12-12	-12	1	-12	1			-12 -12S	2	-23	2
5410-16-16	-16	1	-16	1			-16 -16S	2	-28	2
5410-4-4	-4	1	-4	1			-4 -4S	2	-12	2
5410-6-8	-8	1	-8	1			-6 -8S	2	-17	2
5410-8-8	-8	1	-8	1			-8 -8S	2	-17	2
5410-S14-10-12			-12	1			-10 -12S	1	-23	1
5410-S14-12-12			-12	1			-12 -12S	1	-23	1
5410-S14-16-16			-16	1			-16 -16S	1	-28	1
5410-S14-4-4			-4	1			-4 -4S	1	-12	1
5410-S14-6-4			-4	1			-6 -4S	1	-12	1
5410-S14-6-8			-8	1			-6 -8S	1	-17	1
5410-S14-8-8			-8	1			-8 -8S	1	-17	1
5410-S17-10-12	-12	1					-10 -12S	1	-23	1
5410-S17-12-12	-12	1					-12 -12S	1	-23	1
5410-S17-16-16	-16	1					-16 -16S	1	-28	1
5410-S17-4-4	-4	1					-4 -4S	1	-12	1
5410-S17-6-4	-4	1					-6 -4S	1	-12	1
5410-S17-6-8	-8	1					-6 -8S	1	-17	1
5410-S17-8-8	-8	1					-8 -8S	1	-17	1

FLUID TRANSFER AND HYDRAULIC

PNEUMATIC

SPECIAL APPLICATIONS

DIAGNOSTIC

AGRICULTURE

REFRIGERANT

5400 Series Low Air Inclusion Refrigerant

FLUID TRANSFER
AND HYDRAULIC

PNEUMATIC

SPECIAL APPLICATIONS

DIAGNOSTIC

AGRICULTURE

REFRIGERANT

Assembly Instructions/Component Part Numbers

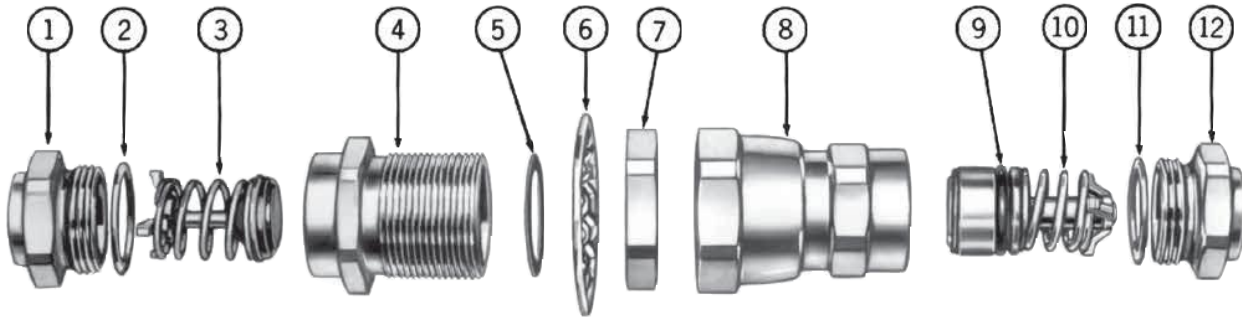

Typical Male Coupling Half (S2)

Assembly Instructions

Steps:

- After tubing or hose has been connected to adapters ① and ⑭, install O-Rings ② and ⑩* on adapters. Be sure O-Rings are not twisted.
- Oil O-Rings ② and ⑩ liberally with system fluid to prevent them from scuffing and tearing when coupling body is threaded on adapter.
- S2 Half—Lubricate poppet face with system fluid. Insert poppet valve assembly ③ into body ④. Tighten body ④ on adapter ①. After body and adapter make metal-to-metal contact, tighten by rotating body ④ 1/8" with respect to adapter ① or torque per table value.
S5 Half—Oil O-Ring ⑨* liberally with system fluid. Insert valve and sleeve assembly 10 into body ⑥. Tighten body ⑥ on adapter ⑭. After body and adapter make metal-to-metal contact, tighten by rotating body ⑥ 1/8" with respect to adapter ⑭ or torque per table value.
- Coupling Connection—Lubricate gasket seal ⑤ on 5400-S2 half with system fluid. Thread union nut ⑧ on 5400-S2 half. Tighten union nut to torque values shown in table. Be sure S2 and S5 bodies do not rotate during connection.

Typical Female Coupling Half (S5)

Bulkhead Mounting—S2 Half

Install lock washer ⑥ on S2 half. Insert S2 half through bulkhead, and tighten jam nut ⑦ so that lock washer teeth are fully compressed.

NOTE: Lock washer 6 must be between hex of S2 half and bulkhead.

Maximum Bulkhead Thickness

Body Size	Lock Washer Installed	Lock Washer Not Used
1/4	.206	.256
1/2	.136	.203
3/4	.232	.292
1	.101	.161

Torque Values

Recommended torque values in ft. lbs., are listed below.

Dash Size	Adapter to Body		
	Braze Type or Aluminum	Non-braze Type Steel or Brass	S2 Half to S5 Half
-4	6-8	12-15	10-12
-8	15-20	35-45	35-37
-12	35-40	45-55	45-47
-16	50-60	55-65	65-67

*IMPORTANT: Generous lubrication is required for all gaskets and O-Rings. Use refrigeration oil only when used in refrigerant system.

Component Part Numbers

Item Number	Dash Size→ O.D. Tube Size→	-4 1/4"-3/8"	-8 1/4"-5/8"	-12 5/8"-7/8"	-16 7/8"-13/8"	Line Ref.
Typical Male Half						1
1	Tubing Adapter	202208-* -4	202208-* -8	202208-* -12	202208-* -16	2
2	O-Ring	22546-12	22546-17	22546-23	22546-28	3
3	Poppet Valve Assembly	5400-S20-4	5400-S20-8	5400-S20-12	5400-S20-16	4
4	Body	5400-17-4	5400-17-8	5400-17-12	5400-17-16	5
5	Gasket Seal	22008-4	22008-8	22008-12	22008-16	6
6	Lock Washer	5400-54-4S	5400-54-8S	5400-54-12S	5400-54-16S	7
7	Jam Nut	5400-53-4S	5400-53-8S	5400-53-12S	5400-53-16S	8
Typical Female Half						9
8	Union Nut and Body Assembly	5400-S16-4	5400-S16-8	5400-S16-12	5400-S16-16	10
9	O-Ring	FF91178-10	FF91178-112	FF91178-116	22546-214	11
10	Valve and Sleeve Assembly	5400-S19-4	5400-S19-8	5400-S19-12	5400-S19-16	12
11	O-Ring	22546-12	22546-17	22546-23	22546-28	13
12	Tubing Adapter	202208-* -4	202208-* -8	202208-* -12	202208-* -16	14

*Specify O.D. Tubing size of adapter required in 16th of an inch. Example: -4 coupling with 3/8" O.D. tubing is 6/16 or -6. Part number is then 202208-6-4.

Part Number Index

Part Number	Page Number	Part Number	Page Number
10	70, 78, 88	585	76, 84
11	70, 78, 89	590	76
13	70, 78, 89	900	70
14	70, 78, 88	1100	70
16	71, 79, 89	1200	70
17	71, 79, 89	1300	70
38	73, 81	1800	71
40	73, 81, 106	2607	88, 109
41	73, 81, 107	2608	88, 109
42	73, 81, 106	2609	89, 109
43	73, 81, 107	2800	78
44	73, 81, 106	2900	78
52	75, 83, 106	3000	78
53	75, 83, 107	3200	78
55	75, 83, 107	3600	79
56	75, 83, 106	3800	79
57	75, 83, 107	3804	110
59	76, 84, 107	3806	110
60	76, 84, 107	3807	110
101	94	3946	89, 109
103	94	3947	89, 109
104	95	4000	81
105	94	4100	81
180	93	4200	81
183	93	4300	81
186	93	4400	81
187	93	5000	83
189	93	5200	83
210	109	5500	83
310	110	5603	22
400	73	5603	144
404	73, 82, 107	5900	84
406	73, 82, 107	6300	85
408	73, 82, 107	6500	86
410	73	6900	86
420	73	40600	82
430	73	40800	82
440	73	50100	83
450	73	50400	84
500	75	62210	109
501	75	100008	132
510	75	100010	132
520	75	100506	132
540	75	100508	132
550	75	100510	132
570	76	100512	132
580	76	210022	109

Part Number Index

Part Number	Page Number	Part Number	Page Number
210212	109	10FFP75UN	37
210213	109	10FFP87UN	37
210215	109	10FFPCUP37	42
300043	78	10FFPCUP37BS	42
310222	110	10FFPCUP50	42
310313	110	10FFPCUP50BS	42
530143	75	12FFPCUP50	42
23203004	107	12FFPCUP50BS	42
23203013	106	12FFPCUP56UN	42
23203014	106	12FFPCUP75UN	42
23203024	107	10FFS37	35
23203025	107	10FFS37BS	35
23203300	107	10FFS50	35
23204005	107	10FFS50BS	35
23204014	106	10FFS56ORM	36
23204015	106	10FFS56UN	35
23204025	107	10FFS75ORM	36
23204026	107	10FFS75UN	35
23204400	107	10FFS87UN	35
00A	97	32FFS125	35
01A	97	32FFS125BS	35
02A	97	32FFS162UN	35
03A	97	10G	70, 78, 88
04R	97	10H41	9
05R	97	10H41BS	9
07A	98	10K41	10
08A	98	10K41BS	10
09A	98	10NK	70, 78, 88
100006E	132	10S41	125
100012E	132	10S41BS	125
1000E	70	10T40	124
100E	95	10T41	125
102E	95	110E	95
10C	70, 78, 88	111E	95
10FFP37	37	112E	95
10FFP37BS	37	11B	70, 78, 89
10FFP50	37	11G	70, 78, 89
32FFP125	37	11NK	70, 78, 89
32FFP162UN	37	12E	70, 78, 88
10FFP50BS	37	12FFP106UN	37
10FFP56ORM	38	12FFP50	37
10FFP56ORM143	38	12FFP50BS	37
10FFP56ORM192	38	12FFP75	37
10FFP56UN	37	12FFP75BS	37
10FFP75ORM	38	12FFP75UN	37
10FFP75ORM143	38	12FFP87UN	37
10FFP75ORM192	38	12FFS106UN	35

Part Number Index

Part Number	Page Number	Part Number	Page Number
12FFS50	35	16T50	124
12FFS50BS	35	16T51	125
12FFS75	35	1700E	71
12FFS75BS	35	1700P	71
12FFS75UN	35	17G	71, 79, 89
12FFS87UN	35	17NK	71, 79, 89
12G	70, 78, 88	17P	71, 79, 89
12H41	9	185E	95
12H41BS	9	18E	71, 79, 89
12H46	9	19FFP100	37
12H46BS	9	19FFP100BS	37
12K41	10	19FFP106UN	37
12K41BS	10	19FFP131UN	37
12K46	10	19FFP75	37
12K46BS	10	19FFP75BS	37
12S46	125	19FFS100	35
12S46BS	125	19FFS100BS	35
12T45	124	19FFS106UN	35
12T46	125	19FFS131UN	35
14G	70, 78, 88	19FFS75	35
150-22-12	50	19FFS75BS	35
150-22-16	50	1G1	94
150-22-20	50	1G10E	95
150-22-5	50	1G12E	95
150-22-8	50	1G2	95
15E	70, 78, 89	1G3E	94
1600E	71	1G5E	94
1600P	71	1GB3	95
16FFP106UN	37	1GB7	95
16FFP50	37	1GD9	95
16FFP50BS	37	1H11	9
16FFP75	37	1H4	9
16FFP75BS	37	1K11	10
16FFP75UN	37	1K4	10
16FFP87UN	37	1S10	124
16FFS106UN	35	1S10BS	124
16FFS50	35	1S11	125
16FFS50BS	35	1S11BS	125
16FFS75	35	1S12	126
16FFS75BS	35	1S17	126
16FFS75UN	35	1SB1	72
16FFS87UN	35	1SB3	72
16G	71, 79, 89	1SB5E	72
16NK	71, 79, 89	1SB7	72
16P	71, 79, 89	1SC5	72
16S51	125	1SC7	72
16S51BS	125	1SC9	72

Part Number Index

Part Number	Page Number	Part Number	Page Number
1SD11	72	25FFP100BS	37
1SD5	72	25FFP125	37
1SD7	72	25FFP125BS	37
1SD9	72	25FFP131UN	37
1T10E	122	25FFP162UN	37
1T11	123	40FFP150	37
1T15	122	40FFP150BS	37
202208-*–12	146	40FFP187UN	37
202208-*–16	146	50FFP200	37
202208-*–4	146	50FFP200BS	37
202208-*–8	146	50FFP250UN	37
20AP37F	89, 110	25FFS100	35
20AP37M	88, 109	25FFS100BS	35
20H51	9	25FFS125	35
20H51BS	9	25FFS125BS	35
20H56	9	25FFS131UN	35
20H56BS	9	25FFS162UN	35
20H61	9	40FFS150	40
20H61BS	9	40FFS150BS	40
20K51	10	40FFS187UN	35
20K51BS	10	50FFS200	40
20K56	10	50FFS200BS	40
20K56BS	10	50FFS250UN	35
20K61	10	2608B	88, 109
20K61BS	10	2609B	88, 109
20S56	123	28S12F	95
20T56	123	28S25M	95
210B	109	2DBPG143	48
21AP25F	89	2DBPG242	48
21AP25H	89	2DBPG292	48
21AP25M	88	2DBPG503	48
22008–12	146	2DBSG143	48
22008–16	146	2DBSG242	48
22008–4	146	2DBSG292	48
22008–8	146	2DBSG503	48
22238E	89, 109	2H16	9
22239E	110	2H16BS	9
22546–12	146	2H6	9
22546–17	146	2HIG10	119
22546–214	146	2HIG11	119
22546–23	146	2HIG15	119
22546–28	146	2HIG16	119
24AP25FBS	90	2HIG20	119
24AP25FG	90	2HIG720	119
24AP25MBST	90	2HIGLLRA720	119
24AP50MBST	90	2HIL10	120
25FFP100	37	2HIL11	120

Part Number Index

Part Number	Page Number	Part Number	Page Number
2HIL15	120	2R17	103
2HIL16	120	2R185C7	103
2HIL20	120	2R185C9	103
2HIL720	120	2R18B1	103
2HILLRA720	120	2R18B11	103
2K16	10	2R18B3	103
2K16BS	10	2R18B7	103
2K6	10	2R195	103
2KIGF	119	2R20	102
2KIGF15	119	2R21	102
2KIGF16	119	2R22	103
2KIGF20	119	2R23D11	103
2KIGF720	119	2R23D13	103
2KILF	120	2R23D7	103
2KILF15	120	2R23D9	103
2KILF16	120	2R25	102
2KILF20	120	2R26	102
2KILF720	120	2R27	103
2L10	102	2R28P13	103
2L11	102	2R28P15	103
2L15	102	2S15	122
2L15G	102	2S16	123
2L16	102	2S16BS	123
2L16G	102	2S17	124
2L17	103	2T15	122
2L185C7	103	2T16	123
2L185C9	103	3100E	78
2L18B3	103	31AP25F	73
2L195	103	31AP25M	73
2L20	102	31AP37F	73
2L20G	102	31AP37M	73
2L21	102	3300E	78
2L22	103	3600P	79
2L23D11	103	3700E	79
2L23D13	103	3700P	79
2L23D5	103	3H21	9
2L23D7	103	3H21BS	9
2L23D9	103	3H8	9
2L25	102	3K21	10
2L26	102	3K21BS	10
2L27	103	3K8	10
2L28P13	103	3L10	104
2L28P15	103	3L15	104
2R10	102	3L15G	104
2R11	102	3L16	104
2R15	102	3L16G	104
2R16	102	3L17	105

Part Number Index

Part Number	Page Number	Part Number	Page Number
3L17G	105	3R23D7	105
3L195	105	3R23D9	105
3L195G	105	3R25	104
3L20	104	3R26	104
3L20G	104	3R27	105
3L21	104	3R28P13	105
3L22	105	3R28P15	105
3L22G	105	3R28P17	105
3L23D11	105	3R30	104
3L23D7	105	3R31A	104
3L23D9	105	3R32	105
3L25	104	3R33R23	105
3L25G	104	3R33R25	105
3L26	104	3S20	122
3L26G	104	3S20BS	122
3L27	105	3S21	123
3L27G	105	3S21BS	123
3L28P13	105	3S22	124
3L28P15	105	3SA0	79
3L30	104	3SB1	79
3L30G	104	3SB3	79
3L31	104	3SB5	79
3L32	105	3SB7	79
3L32G	105	3SB9	79
3L33R23	105	3SC5	79
3L33R25	105	3SC7	79
3PB1	72, 79	3SC9	79
3PB11	72, 79	3SD11	79
3PB3	72, 79	3SD5	79
3PB5	72, 79	3SD7	79
3PB7	72, 79	3SD9	79
3PB9	72, 79	3T20	122
3PC5	72, 79	3T21	123
3PC7	72, 79	4000A	82
3PC9	72, 79	4004E	74
3PD11	72, 79	4006E	74
3PD5	72, 79	4008E	74
3PD7	72, 79	40400E	81
3PD9	72, 79	40500E	81
3R15	104	4050E	74
3R16	104	40G	73, 80
3R17	105	40NK	73, 80
3R195	105	40SD11	75
3R20	104	40SD7	75
3R21	104	40SD9	75
3R22	105	40SP13	75
3R23D11	105	40SP15	75

Part Number Index

Part Number	Page Number	Part Number	Page Number
40SP17	74	4SP15	81
40SP19	74	4T25	122
4100A	80	4T26	123
41G	73, 80	5000A	83
41NK	73, 80	500A	75
42G	73, 80	5019E	76
43G	73, 80	50E	74, 83
4500E	80	50G	75, 83
45E	73, 80, 107	50SP13	76
4DBPG143	48	50SP15	76
4DBPG242	48	50SR23	76
4DBPG292	48	50SR25	76
4DBPG503	48	50SR27	76
4DBSG143	48	5100-10B	50
4DBSG242	48	5100-12B	50
4DBSG292	48	5100-16B	50
4DBSG503	48	5100-20B	50
4HFR26	17	5100-22-245	50
4HP10	9	5100-24B	50
4HP26	9	5100-4B	50
4HP26BS	9	5100-6B	50
4KFR26	17	5100-8B	50
4KP10	10	5100E	83
4KP26	10	5100-S2-10B	50
4KP26BS	10	5100-S2-12B	50
4PB3	74, 81	5100-S2-16B	50
4PB5	74, 81	5100-S2-20B	50
4PB7	74, 81	5100-S2-24B	50
4PD11	74, 81	5100-S2-4B	50
4PD15	74, 81	5100-S2-6B	50
4PD7	74, 81	5100-S2-8B	50
4PD9	74, 81	5100-S4-10B	50
4PP13	74, 81	5100-S4-12B	50
4PP15	74, 81	5100-S4-16B	50
4PP19	74, 81	5100-S4-20B	50
4S25	122	5100-S4-24B	50
4S25BS	122	5100-S4-4B	50
4S26	123	5100-S4-6B	50
4S26BS	123	5100-S4-8B	50
4S27	124	5100-S5-10B	50
4SB3	81	5100-S5-12B	50
4SB7	81	5100-S5-16B	50
4SC7	81	5100-S5-20B	50
4SD11	81	5100-S5-24B	50
4SD7	81	5100-S5-4B	50
4SD9	81	5100-S5-6B	50
4SP13	81	5100-S5-8B	50

Part Number Index

Part Number	Page Number	Part Number	Page Number
5100-S7-12	50	5400-17-12	146
5100-S7-16	50	5400-17-16	146
5100-S7-20	50	5400-17-4	146
5100-S7-24	50	5400-17-8	146
5100-S7-5	50	5400-53-12S	146
5100-S7-8	50	5400-53-16S	146
5100-S9-12	50	5400-53-4S	146
5100-S9-16	50	5400-53-8S	146
5100-S9-20	50	5400-54-12S	146
5100-S9-24	50	5400-54-16S	146
5100-S9-5	50	5400-54-4S	146
5100-S9-8	50	5400-54-8S	146
5101-10B	50	5400E	83
5101-12B	50	5400-S16-12	146
5101-16B	50	5400-S16-16	146
5101-20B	50	5400-S16-4	146
5101-24B	50	5400-S16-8	146
5101-4B	50	5400-S19-12	146
5101-6B	50	5400-S19-16	146
5101-8B	50	5400-S19-4	146
5110-10B	50	5400-S19-8	146
5110-12B	50	5400-S20-12	146
5110-20B	50	5400-S20-16	146
5110-4B	50	5400-S20-4	146
5110-6B	50	5400-S20-8	146
5110-8B	50	5400-S2-12	143
5110-S5-10B	50	5400-S2-16	143
5110-S5-12B	50	5400-S2-4	143
5110-S5-16B	50	5400-S2-8	143
5110-S5-20B	50	5400-S5-12	143
5110-S5-24B	50	5400-S5-16	143
5110-S5-4B	50	5400-S5-4	143
5110-S5-6B	50	5400-S5-8	143
5110-S5-8B	50	5401-S14-10-12	145, 144
5111-10B	50	5401-S14-10-8	145
5111-12B	50	5401-S14-12-12	145, 144
5111-16B	50	5401-S14-16-16	145, 144
5111-20B	50	5401-S14-4-4	145, 144
5111-24B	50	5401-S14-6-4	145, 144
5111-4B	50	5401-S14-6-8	145, 144
5111-6B	50	5401-S14-8-8	145, 144
5111-8B	50	5401-S17-10-12	145, 144
52G	75, 83	5401-S17-10-8	150
5300E	83	5401-S17-12-12	149, 150
530E	76	5401-S17-14-16	150
53A	75, 83	5401-S17-16-16	149
53G	75, 83	5401-S17-4-4	145, 144

Part Number Index

Part Number	Page Number	Part Number	Page Number
5401-S17-6-4	145, 144	560078-6-6S	21
5401-S17-6-8	145	560078-8-10S	21
5401-S17-8-8	145, 144	5600-8-10S	19
5410-12-12	145	5601-12-10S	19
5410-4-4	145	5601-12-12S	19
5410-6-8	145	5601-2-4S	19
5410-8-8	145	5601-4-4S	19
5410-10-12	143	5601-6-6S	19
5410-12-12	143	5601-8-10S	19
5410-16-16	143, 145	5602-12-10S	19, 21
5410-4-4	143	5602-12-12S	19
5410-6-4	143	5602-2-4S	19
5410-6-8	143	5602-4-4S	19
5410-8-8	143	5602-6-6S	19
5410-S14-10-12	143, 145	5602-8-10S	19, 21
5410-S14-12-12	143, 145	5606-10-10S	21
5410-S14-16-16	143, 145	5606-12-12S	21
5410-S14-4-4	143, 145	5606-16-16S	21
5410-S14-6-4	143, 145	5606-4-4S	21
5410-S14-6-8	143, 145	5606-6-6S	21
5410-S14-8-8	143, 145	5606-8-10S	21
5410-S17-10-12	143, 145	5608-10-10S	21
5410-S17-12-12	143, 145	5608-12-12S	21
5410-S17-16-16	143, 145	5608-16-16S	21
5410-S17-4-4	143, 145	5608-4-4S	21
5410-S17-6-4	143, 145	5608-6-6S	21
5410-S17-6-8	143, 144, 145	5608-8-10S	21
5410-S17-8-8	143, 145	5610-10-10S	21
54E	75, 83, 106	5610-12-12S	21
54G	75, 83	5610-16-16S	21
550NV	75	5610-4-4S	21
55G	75, 82	5610-6-6S	21
5600-12-10S	19	5610-8-10S	21
5600-12-12S	19	5620-12-12S	22
560024-12-12	24	5620-16-16S	22
560024-16-16	24	5620-8-10S	22
560024-8-10	24	5642-12-10S	19
5600-2-4S	19	5642-12-12S	19
5600-4-4S	19	5642-16-16S	19
560049-12-12	24	5642-2-4S	19
560049-16-16	24	5642-4-4S	19
560049-8-10	24	5642-6-6S	19
5600-6-6S	19	5642-8-10S	19
560078-10-10S	21	5643-12-10S	19
560078-12-12S	21	5643-12-12S	19
560078-16-16S	21	5643-16-16S	19
560078-4-4S	21	5643-2-4S	19

Part Number Index

Part Number	Page Number	Part Number	Page Number
5643-4-4S	19	5PD9	75, 83
5643-6-6S	19	5PP13	75, 83
5643-8-10S	19	5PP15	75, 83
5644-12-10S	19, 21	5PR23	75, 83
5644-12-12S	19	5PR25	75, 83
5644-16-16S	19	5PR27	75, 83
5644-2-4S	19	5SD11	83
5644-4-4S	19	5SD5	83
5644-6-6S	19	5SD7	83
5644-8-10S	19	5SD9	83
5644-8-10S	21	5SP13	83
565006-12-10S	21	5SP15	83
565006-8-10S	21	5SR23	83
565007-12-10S	21	5SR25	83
565007-8-10S	21	5SR27	83
5650-12-10S	21	60G	75, 83
5650-8-10S	21	61E	75, 83, 107
5651-12-10S	21	61G	75, 83
5651-8-10S	21	6200E	84
5657-10	22, 141	6400E	84
5657-12	22	64A	84
5657-16	22	64GA	84
5657-4	22	65A	84
5657-6	22	65GAS	84
5659-10	22, 141	6600E	84
5659-12	22	66AE	84
5659-16	22	66GA	84
5659-4	22	6700E	84
5659-6	22	67A	84
5690-12-12S	22	67GAS	84
5690-16-16S	22	6800E	85
5690-8-10S	22	68A	84
5691-12-12S	22	69A	84
5691-16-16S	22	6B3	98
5691-8-10S	22	6B5	98
56G	75, 82	6B7	98
5700E	83	6D11	98
5800E	83	6D7	98
585G	76, 83	6D9	98
59G	76, 83	6DBPG143	48
5PB3	76, 83	6DBPG242	48
5PB5	76, 83	6DBPG292	48
5PB7	76, 83	6DBPG503	48
5PD11	76, 83	6DBSG143	48
5PD13	76, 83	6DBSG242	48
5PD5	76, 83	6DBSG292	48
5PD7	76, 83	6DBSG503	48

Part Number Index

Part Number	Page Number	Part Number	Page Number
6FFP25	37	8S35BS	122
6FFP25BS	37	8S36	123
6FFP56UN	37	8S36BS	123
6FFS25	35	8S37	124
6FFS25BS	35	8T35	122
6FFS56UN	35	8T36	123
6HFR31	17	8T37	124
6HP12	9	A1	99
6HP31	9	A2	99
6HP31BS	9	A3P	99
6KFR31	17	A4L	99
6KP12	10	A5L	99
6KP31	10	A7	100
6KP31BS	10	A8	100
6S30	122	A9	100
6S30BS	122	B10	70, 78, 88
6S31	123	B10H41	12
6S31BS	123	B10K41	13
6S32	124	B10T40	122
6T30	122	B10T40BS	122
6T31	123	B10T41	123
7000E	85	B10T41BS	123
70A	85	B12FS75F13	133
70GA	85	B12H41	12
71A	85	B12H41BS	12
71GA	85	B12H46	12
72A	85	B12H46BS	12
7B3	100	B12K41	13
7B7	100	B12K41BS	13
800E	70	B12K46	13
8DBPG143	48	B12K46BS	13
8DBPG242	48	B12T45	122
8DBPG292	48	B12T45BS	122
8DBPG503	48	B12T46	123
8DBSG143	48	B12T46BS	123
8DBSG242	48	B16FS100F21	133
8DBSG292	48	B16T50	122
8DBSG503	48	B16T51	123
8HFR36	17	B16T51BS	123
8HP16	9	B17	71, 78, 89
8HP36	9	B1H11	12
8HP36BS	9	B1K11	13
8KFR36	17	B1T10	122
8KP16	10	B1T11	123
8KP36	10	B1T11BS	123
8KP36BS	10	B1T12	124
8S35		B1T15	122

Part Number Index

Part Number	Page Number	Part Number	Page Number
B1T17	124	B3T20	122
B20H51	12	B3T20BS	122
B20H51BS	12	B3T21	123
B20H56	12	B3T21BS	123
B20H56BS	12	B3T22	124
B20H61	12	B40	73, 80
B20H61BS	12	B40E	74, 81
B20K51	13	B42	73, 80
B20K51BS	13	B43	73, 80
B20K56	13	B4FS25F2	133
B20K56BS	13	B4HP26	12
B20K61	13	B4HP26BS	12
B20K61BS	13	B4KP26	13
B20T55	122	B4KP26BS	13
B20T56	137	B4T25	122
B23AS25F	89	B4T25BS	122
B23AS25FBS	89	B4T26	123
B23AS25H	89	B4T26BS	123
B23AS25M	88	B4T27	124
B23AS25MBST	88	B52	75, 82
B23AS31H	89	B54	75, 82
B23AS37F	89	B60	83
B23AS37FBS	89	B64A	84
B23AS37H	89	B66A	84
B23AS37M	88	B6FS37F5	133
B23AS37MBST	88	B6HP31	12
B23AS50H	89	B6HP31BS	12
B23AS50MBST	88	B6KP31	13
B24AS25F	90	B6KP31BS	13
B24AS25FBS	90	B6T30	122
B24AS25M	90	B6T30BS	122
B24AS37FBS	90	B6T31	124
B24AS50FBS	90	B6T31BS	124
B24FS150F45	133	B6T32	124
B2H16	12	B71A	87
B2H16BS	12	B8FS50F8	133
B2K16	13	B8HP36	12
B2K16BS	13	B8HP36BS	12
B2T15	122	B8KP36	13
B2T15BS	122	B8KP36BS	13
B2T16	123	B8T35	122
B2T16BS	123	B8T35BS	122
B2T17	124	B8T36	123
B3H21	12	B8T36BS	123
B3H21BS	12	B8T37	124
B3K21	13	CR10FFPDG	38, 40
B3K21BS	13	CR10FFPLB	38, 40

Part Number Index

Part Number	Page Number	Part Number	Page Number
CR10FFPRD	38, 40	FA37M37M	131
CR10FFPYL	38, 40	FA37P25M	131
CR10FFSDG	38, 40	FD14-1001-12-06	112
CR10FFSLB	38, 40	FD14-1004-12-12	113
CR10FFSP93	38, 40	FD14-1204-06	113
CR10FFSRD	38, 40	FD14-1206-01	112
CR10FFSYL	38, 40	FD14-1206-01	112
CR12FFPDG	38, 40, 42, 48	FD14-1206-01	112
CR12FFPLB	38, 40, 42, 48	FD14-1206-01	112
CR12FFPRD	38, 40, 42, 48	FD14-1206-02	112
CR12FFPYL	38, 40, 42, 48	FD14-1206-02	112
CR12FFSDG	38, 40, 48	FD14-1206-02	112
CR12FFSLB	38, 40, 48	FD14-1206-03	112
CR12FFSP93	38, 40, 42	FD14-1206-04	112
CR12FFSRD	38, 40, 48	FD14-1206-04	112
CR12FFSYL	38, 40, 48	FD14-1206-05	112
CR16FFPDG	38, 40	FD14-1206-06	112
CR16FFPLB	38, 40	FD14-1206-07	112
CR16FFPRD	38, 40	FD14-1206-08	112
CR16FFPYL	38, 40	FD14-1206-09	112
CR16FFSDG	38, 40	FD14-1206-10	112
CR16FFSLB	38, 40	FD14-1206-11	112
CR16FFSP93	38, 40	FD14-1210-06	112, 113
CR16FFSRD	38, 40	FD14-4002-01-06	112
CR16FFSYL	38, 40	FD14-4002-02-06	112
CR19FFPDG	38, 40	FD14-4002-03-06	112
CR19FFPLB	38, 40	FD14-4002-05-06	112
CR19FFPRD	38, 40	FD14-4002-06-06	112
CR19FFPYL	38, 40	FD14-4002-07-06	112
CR19FFSDG	38, 40	FD14-4002-08-06	112
CR19FFSLB	38, 40	FD14-4002-09-06	112
CR19FFSP93	38, 40	FD14-4002-10-06	112
CR19FFSRD	38, 40	FD14-4002-11-06	112
CR19FFSYL	38, 40	FD14-4002-12-06	112
CR4DBSP93	48	FD14-4002-14-06	112
CRKIT10FF	38, 40	FD14-4002-16-06	112
CRKIT12FF	38, 40	FD14-4002-17-06	112
CRKIT16FF	38, 40	FD14-4002-18-06	112
CRKIT19FF	38, 40	FD14-4002-19-06	112
CRKIT4DB	48	FD14-4002-20-06	112
FA25AR25M	131	FD14-4002-21-06	112
FA25F25M	131	FD14-4002-22-06	112
FA25F37M	131	FD14-4002-23-06	112
FA25M25M	131	FD14-4002-24-06	112
FA25P25M	131	FD14-4002-25-06	112
FA37F37M	131	FD14-4002-26-06	112
FA37H37M	131	FD14-4002-27-06	112

Part Number Index

Part Number	Page Number	Part Number	Page Number
FD14-4002-29-06	112	FD56-1012-16-16S	21
FD14-4003-10-06	112	FD56-1037-04-04	20
FD15-1000-02	135	FD56-1037-06-06	20
FD15-1000-04	135	FD56-1037-08-10	20
FD15-1002-04	135	FD56-1037-08-10	20
FD15-1025-04	135	FD56-1037-12-12	20
FD15-1026-04	135	FD56-1037-16-16	20
FD17-1003-04-04	114	FD56-1062-02-04	19
FD17-1062-04	114	FD56-1062-04-04	19
FD17-1064-04	114	FD56-1062-06-06	19
FD17-1082-10-04	114	FD56-1062-08-10	19, 21
FD35-1000-06-06	66	FD56-1062-12-10	19, 21
FD35-1001-06-06	66	FD56-1062-12-12	19
FD35-1002-06-06	66	FD56-1062-16-16	19
FD35-1006-06-06	66	FD56-1064-02-04	19
FD35-1007-06-06	66	FD56-1064-04-04	19
FD35-1008-06-06	66	FD56-1064-06-06	19
FD35-1042-06	66	FD56-1064-08-10	19
FD35-1052-06-06	66	FD56-1064-12-10	19
FD48-1001-04-04	140	FD56-1064-12-12	19
FD48-1002-04-04	140	FD56-1064-16-16	19
FD48-1042-04	140	FD56-1065-02-04	19
FD49-1001-06-06	46	FD56-1065-04-04	19
FD49-1001-08-06	46	FD56-1065-06-06	19
FD49-1002-06-06	46	FD56-1065-08-10	19
FD49-1002-08-06	46	FD56-1065-12-10	19
FD49-1004-08-06	46	FD56-1065-12-12	19
FD49-1005-08-06	46	FD56-1065-16-16	19
FD49-1014-06-06	46	FD56-1070-08-10	21
FD49-1014-08-06	46	FD56-1070-12-10	21
FD49-1042-06	46	FD56-1071-08-10	21
FD49-1057-06-06	46	FD56-1071-12-10	21
FD49-1057-08-06	46	FD56-1072-04-04	21
FD56-1001-08-10	24	FD56-1072-06-06	21
FD56-1001-12-12	24	FD56-1072-08-10	21
FD56-1001-16-16	24	FD56-1072-10-10	21
FD56-1009-04-04S	21	FD56-1072-12-12	21
FD56-1009-06-06S	21	FD56-1074-04-04	21
FD56-1009-08-10S	21	FD56-1074-06-06	21
FD56-1009-10-10S	21	FD56-1074-08-10	21
FD56-1009-12-12S	21	FD56-1074-10-10	21
FD56-1009-16-16S	21	FD56-1074-12-12	21
FD56-1012-04-04S	21	FD56-1075-04-04	21
FD56-1012-06-06S	21	FD56-1075-06-06	21
FD56-1012-08-10S	21	FD56-1075-08-10	21
FD56-1012-10-10S	21	FD56-1075-10-10	21
FD56-1012-12-12S	21	FD56-1123-04-04	20

Part Number Index

Part Number	Page Number	Part Number	Page Number
FD56-1123-06-06	20	FD56-1221-16-16	22
FD56-1123-08-10	20	FD56-1225-04-04	20
FD56-1123-12-12	20	FD56-1225-06-06	20
FD56-1123-16-16	20	FD56-1225-08-10	20
FD56-1125-04-04	20	FD56-1225-12-12	20
FD56-1125-06-06	20	FD56-1225-16-16	20
FD56-1125-08-10	20	FD56-1226-04-04	20
FD56-1125-12-12	20	FD56-1226-06-06	20
FD56-1125-16-16	20	FD56-1226-08-10	20
FD56-1196-04-04	20	FD56-1226-12-12	20
FD56-1196-06-06	20	FD56-1226-16-16	20
FD56-1196-08-10	20	FD56-1233-08-10	22
FD56-1196-12-12	20	FD56-1233-12-12	22
FD56-1196-16-16	20	FD56-1233-16-16	22
FD56-1201-04-04	20	FD56-1234-08-10	22
FD56-1201-06-06	20	FD56-1234-12-12	22
FD56-1201-08-10	20	FD56-1234-16-16	22
FD56-1201-12-12	20	FD56-1239-08-10	19
FD56-1201-16-16	20	FD56-1239-12-12	19
FD56-1204-04-04	20	FD56-1239-16-16	19
FD56-1204-06-06	20	FD56-1270-06-06	21
FD56-1204-08-10	20	FD56-1270-08-10	21
FD56-1204-12-12	20	FD56-1270-12-12	21
FD56-1204-16-16	20	FD56-1270-16-16	21
FD56-1205-04-04	20	FD69-1000-060806	116
FD56-1205-06-06	20	FD69-1000-060808	116
FD56-1205-08-10	20	FD69-1000-080806	116
FD56-1205-12-12	20	FD69-1000-080808	116
FD56-1205-16-16	20	FD69-1001-06-08	116
FD56-1207-04-04	20	FD69-1001-08-08	116
FD56-1207-06-06	20	FD69-1002-06-08	116
FD56-1207-08-10	20	FD69-1002-08-08	116
FD56-1207-12-12	20	FD69-1010-080808	116
FD56-1207-16-16	20	FD69-1011-08-08	116
FD56-1208-04-04	20	FD69-1012-08-08	116
FD56-1208-06-06	20	FD69-1026-06-08	116
FD56-1208-08-10	20	FD69-1026-08-08	116
FD56-1208-12-12	20	FD69-1027-060806	116
FD56-1208-16-16	20	FD69-1027-060808	116
FD56-1209-08-10	22	FD69-1027-080806	116
FD56-1209-12-12	22	FD69-1027-080808	116
FD56-1209-16-16	22	FD69-1028-06-08	116
FD56-1210-08-10	22	FD69-1028-08-08	116
FD56-1210-12-12	22	FD69-1029-060806	116
FD56-1210-16-16	22	FD69-1029-060808	116
FD56-1221-08-10	22	FD69-1029-080806	116
FD56-1221-12-12	22	FD69-1029-080808	116

Part Number Index

Part Number	Page Number	Part Number	Page Number
FD72-1001-08-10	141	FD86-1010-20-20	56
FD76-1002-08-10	141	FD86-1016-16	56
FD76-1010-08-10	141	FD86-1016-20	56
FD83-2046-16-16	117	FD86-1018-16	56
FD83-2052-12-16	117	FD86-1018-20	56
FD83-2052-16-16	117	FD86-1039-16-16	56
FD85-1000-12-12	54	FD86-1039-20-20	56
FD85-1000-16-16	54	FD86-1040-16-16	56
FD85-1000-20-20	54	FD86-1040-20-20	56
FD85-1000-24-24	54	FD86-1041-16-16	56
FD85-1000-32-32	54	FD86-1041-20-20	56
FD85-1001-12-12	54	FD86-1042-16-16	56
FD85-1001-16-16	54	FD86-1042-20-20	56
FD85-1001-20-20	54	FD86-1043-16-16	56
FD85-1001-24-24	54	FD86-1043-20-20	56
FD85-1001-32-32	54	FD86-1044-16-16	56
FD85-1003-12-12	54	FD86-1044-20-20	56
FD85-1003-16-16	54	FD86-1049-16-16	56
FD85-1003-20-20	54	FD86-1049-20-20	56
FD85-1003-24-24	54	FD86-1050-16-16	56
FD85-1003-32-32	54	FD86-1050-20-20	56
FD85-1016-12-12	54	FD86-1051-16-16	56
FD85-1016-16-16	54	FD86-1051-20-20	56
FD85-1016-20-20	54	FD86-1052-16-16	56
FD85-1016-24-24	54	FD86-1052-20-20	56
FD85-1016-32-32	54	FD86-1053-16-16	56
FD85-1017-12-12	54	FD86-1053-20-20	56
FD85-1017-16-16	54	FD86-1054-16-16	56
FD85-1017-20-20	54	FD86-1054-20-20	56
FD85-1017-24-24	54	FD90-1004-03-04	136
FD85-1017-32-32	54	FD90-1004-04-04	136
FD85-1019-12-12	54	FD90-1004-05-04	136
FD85-1019-16-16	54	FD90-1004-06-04	136
FD85-1019-20-20	54	FD90-1012-02-04	136
FD85-1019-24-24	54	FD90-1012-04-04	136
FD85-1019-32-32	54	FD90-1021-02-04	136
FD86-1001-16-16	56	FD90-1021-04-04	136
FD86-1001-20-20	56	FD90-1034-02-04	136
FD86-1002-16-16	56	FD90-1034-04-04	136
FD86-1002-20-20	56	FD90-1035-02-04	136
FD86-1004-16-16	56	FD90-1035-04-04	136
FD86-1004-20-20	56	FD90-1040-04	137
FD86-1006-16-16	56	FD90-1041-04-04	137
FD86-1006-20-20	56	FD90-1044-03-04	136
FD86-1008-16-16	56	FD90-1044-04-04	136
FD86-1008-20-20	56	FD90-1044-05-04	136
FD86-1010-16-16	56	FD90-1044-06-04	136

Part Number Index

Part Number	Page Number	Part Number	Page Number
FD90-1045-02-04	136	FD96-1005-12-12	44
FD90-1045-04-04	136	FD96-1005-12-16	44
FD90-1046-06-04	137	FD96-1005-16-16	44
FD90-1047-06-04	137	FD96-1005-16-20	44
FD90-1061-04-04	137	FD96-1005-20-20	44
FD90-1061-06-04	137	FD96-1005-20-24	44
FD90-1061-08-04	137	FD96-1005-24-24	44
FD90-1090-10-04	137	FD96-1005-32-32	44
FD90-1206-04-04	137	FD96-1009-04	44
FD96-1001-06-06	44	FD96-1009-06	44
FD96-1001-08-06	44	FD96-1009-08	44
FD96-1001-08-08	44	FD96-1009-12	44
FD96-1001-12-08	44	FD96-1009-16	44
FD96-1001-12-12	44	FD96-1009-20	44
FD96-1001-12-16	44	FD96-1009-24	44
FD96-1001-16-16	44	FD96-1009-32	44
FD96-1001-16-20	44	FD96-1010-04	44
FD96-1001-20-20	44	FD96-1010-06	44
FD96-1001-20-24	44	FD96-1010-08	44
FD96-1001-24-24	44	FD96-1010-12	44
FD96-1001-32-32	44	FD96-1010-16	44
FD96-1002-06-06	44	FD96-1010-20	44
FD96-1002-08-06	44	FD96-1010-24	44
FD96-1002-08-08	44	FD96-1010-32	44
FD96-1002-12-08	44	FF098-04	50
FD96-1002-12-12	44	FF098-08	50
FD96-1002-12-16	44	FF098-12	50
FD96-1002-16-16	44	FF098-16	50
FD96-1002-16-20	44	FF098-20	50
FD96-1002-20-20	44	FF098-24	50
FD96-1002-20-24	44	FF10166	116
FD96-1002-24-24	44	FF10593-16	56
FD96-1002-32-32	44	FF10593-20	56
FD96-1004-06-04	44	FF10594-16	56
FD96-1004-08-06	44	FF10594-20	56
FD96-1004-12-08	44	FF10595-16	56
FD96-1004-12-12	44	FF10595-20	56
FD96-1004-12-16	44	FF10596-16	56
FD96-1004-16-16	44	FF10596-20	56
FD96-1004-16-20	44	FF10597-16	56
FD96-1004-20-20	44	FF10597-20	56
FD96-1004-20-24	44	FF10598-16	56
FD96-1004-24-24	44	FF10598-20	56
FD96-1004-32-32	44	FF14783	138
FD96-1005-06-04	44	FF14784	138
FD96-1005-08-06	44	FF14785	138
FD96-1005-12-08	44	FF14786	138

Part Number Index

Part Number	Page Number	Part Number	Page Number
FF14787	138	FTS206	126
FF14788	138	FTS206HP	126
FF14789	139	FTS206V	126
FF14790	139	FTS214	126
FF14791	139	FTS214HP	126
FF14792	139	FTS214V	126
FF14793	139	FTS214VHP	126
FF14794	138, 139	FTS215	126
FF14795	139	FTS215V	126
FF14796	138, 139	FTS216	126
FF14797	139	FTS216HP	126
FF14798	138, 139	FTS216V	126
FF14799	138, 139	FTS216VHP	126
FF14800	138, 139	FTS224	127
FF14801	138, 139	FTS224HP	127
FF91178-10	146	FTS224V	127
FF91178-112	146	FTS224VHP	127
FF91178-116	146	FTS225	127
FTP251	127	FTS225V	127
FTP251BST	127	FTS226	127
FTP251F	127	FTS226HP	127
FTP251FBS	127	FTS226V	127
FTP252	127	FTS226VHP	127
FTP252BST	127	FTS306	126
FTP252F	127	FTS306HP	126
FTP252FBS	127	FTS306V	126
FTP253	127	FTS306VHP	126
FTP253F	127	FTS308	126
FTP352	127	FTS308HP	126
FTP352BST	127	FTS308V	126
FTP352F	127	FTS308VHP	126
FTP352FBS	127	FTS316	126
FTP353	127	FTS316HP	126
FTP353BST	127	FTS316V	126
FTP353F	127	FTS316VHP	126
FTP354	127	FTS318	126
FTP354F	127	FTS318HP	126
FTP554	127	FTS318V	126
FTP554F	127	FTS318VHP	126
FTP556	127	FTS326	127
FTP556F	127	FTS326HP	127
FTS204	126	FTS326V	127
FTS204HP	126	FTS326VHP	127
FTS204V	126	FTS328	127
FTS204VHP	126	FTS328HP	127
FTS205	126	FTS328V	127
FTS205V	126	FTS328VHP	127

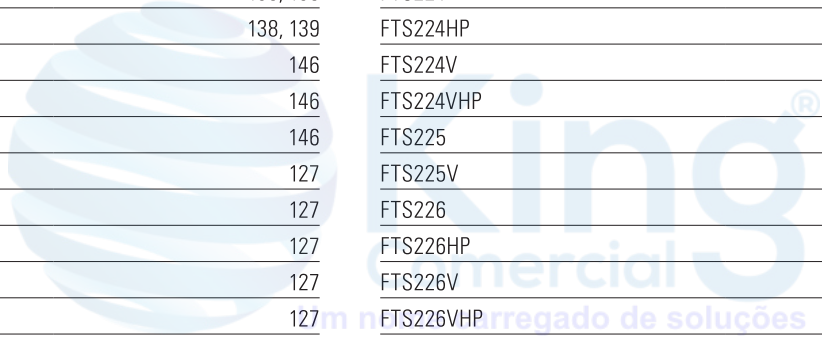

Part Number Index

Part Number	Page Number	Part Number	Page Number
FTS504	126	GR608	98
FTS504HP	126	GR608P	98
FTS504V	126	GR608SL	98
FTS504VHP	126	GR60B3	98
FTS506	126	GR60B3SL	98
FTS506HP	126	GR60B5	98
FTS506V	126	GR60B5SL	98
FTS506VHP	126	GR60B7	98
G5622-12-12	21	GR60B7SL	98
G5622-16-16	21	GR60C5	98
G5622-4-4	21	GR60D11	98
G5622-6-6	21	GR60D7	98
G5622-8-10	21	GR60D9	98
G5623-12-12	20	HA0500100	26
G5623-16-16	20	HA05001E0	26
G5623-4-4	20	HA05001V0	26
G5623-6-6	20	HA0500200	27
G5623-8-10	20	HA05002E0	27
GD1052641	91	HA05002V0	27
GD1052683	91	HA0500300	26
GD1053641	91	HA05003E0	26
GD1053683	91	HA05003V0	26
GD1055601	91	HA0501100	26
GMP1250F	128	HA05011E0	26
GMS1250FH	128	HA05011V0	26
GR600	97	HA0501200	27
GR600SL	97	HA05012E0	27
GR601	97	HA05012V0	27
GR601SL	97	HA0501300	26
GR602	97	HA05013E0	26
GR602SL	97	HA05013V0	26
GR603	97	HA0502100	26
GR603SL	97	HA05021E0	26
GR604	97	HA05021V0	26
GR604R	97	HA0502200	27
GR604RSL	97	HA05022E0	27
GR604SL	97	HA05022V0	27
GR605	97	HA0502300	26
GR605R	97	HA05023E0	26
GR605RSL	97	HA05023V0	26
GR605SL	97	HA0503100	26
GR606	98	HA05031E0	26
GR606P	98	HA05031V0	26
GR606PSL	98	HA0503200	27
GR606SL	98	HA05032E0	27
GR607	98	HA05032V0	27
GR607SL	98	HA0503300	26

Part Number Index

Part Number	Page Number	Part Number	Page Number
HA05033E0	26	HA05212E0	27
HA05033V0	26	HA05212V0	27
HA0504100	26	HA0521300	26
HA05041E0	26	HA05213E0	26
HA05041V0	26	HA05213V0	26
HA0504200	27	HA0522100	26
HA05042E0	27	HA05221E0	26
HA05042V0	27	HA05221V0	26
HA0504300	26	HA0522200	27
HA05043E0	26	HA05222E0	27
HA05043V0	26	HA05222V0	27
HA0505100	26	HA0522300	26
HA05051E0	26	HA05223E0	26
HA05051V0	26	HA05223V0	26
HA0505200	27	HA0523100	26
HA05052E0	27	HA05231E0	26
HA05052V0	27	HA05231V0	26
HA0505300	26	HA0523200	27
HA05053E0	26	HA05232E0	27
HA05053V0	26	HA05232V0	27
HA05061V0	26	HA0523300	26
HA05062E0	27	HA05233E0	26
HA05062V0	27	HA05233V0	26
HA05063E0	26	HA0524100	26
HA05063V0	26	HA05241E0	26
HA05071V0	26	HA05241V0	26
HA05072E0	27	HA0524200	27
HA05072V0	27	HA05242E0	27
HA05073E0	26	HA05242V0	27
HA05073V0	26	HA0524300	26
HA05091V0	26	HA05243E0	26
HA05092E0	27	HA05243V0	26
HA05092V0	27	HA0525100	26
HA05093E0	26	HA05251V0	26
HA0520100	26	HA0525200	27
HA05201E0	26	HA05252E0	27
HA05201V0	26	HA05252V0	27
HA0520200	27	HA0525300	26
HA05202E0	27	HA05253E0	26
HA05202V0	27	HA05253V0	26
HA0520300	26	HA0530100	26
HA05203E0	26	HA05301E0	26
HA05203V0	26	HA05301V0	26
HA0521100	26	HA0530200	27
HA05211E0	26	HA05302E0	27
HA05211V0	26	HA05302V0	27
HA0521200	27	HA0530300	26

Part Number Index

Part Number	Page Number	Part Number	Page Number
HA05303E0	26	HD0514200	27, 30, 33
HA05303V0	26	HD0515100	27, 30, 33
HA0531100	26	HD0515200	27, 30, 33
HA05311E0	26	HD0516100	27, 30, 33
HA05311V0	26	HD0516200	27, 30, 33
HA0531200	27	HD0517100	27, 30, 33
HA05312E0	27	HD0517200	27, 30, 33
HA05312V0	27	HD0519100	27, 30, 33
HA0531300	26	HD0519200	27, 30, 33
HA05313E0	26	HL0500100	29
HA05313V0	26	HL05001E0	29
HA0532100	26	HL05001V0	29
HA05321E0	26	HL0500200	30
HA05321V0	26	HL05002E0	30
HA0532200	27	HL05002V0	30
HA05322E0	27	HL0500300	29
HA05322V0	27	HL05003E0	29
HA0532300	26	HL05003V0	29
HA05323E0	26	HL0501100	29
HA05323V0	26	HL05011E0	29
HA0533100	26	HL05011V0	29
HA05331E0	26	HL0501200	30
HA05331V0	26	HL05012E0	30
HA0533200	27	HL05012V0	30
HA05332E0	27	HL0501300	29
HA05332V0	27	HL05013E0	29
HA0533300	26	HL05013V0	29
HA05333E0	26	HL0502100	29
HA05333V0	26	HL05021E0	29
HA0534100	26	HL05021V0	29
HA05341E0	26	HL0502200	30
HA05341V0	26	HL05022E0	30
HA0534200	27	HL05022V0	30
HA05342E0	27	HL0502300	29
HA05342V0	27	HL05023E0	29
HA0534300	26	HL05023V0	29
HA05343E0	26	HL0503100	29
HA05343V0	26	HL05031E0	29
HD0510100	27, 30, 33	HL05031V0	29
HD0510200	27, 30, 33	HL0503200	30
HD0511100	27, 30, 33	HL05032E0	30
HD0511200	27, 30, 33	HL05032V0	30
HD0512100	27, 30, 33	HL0503300	29
HD0512200	27, 30, 33	HL05033E0	29
HD0513100	27, 30, 33	HL05033V0	29
HD0513200	27, 30, 33	HL0504100	29
HD0514100	27, 30, 33	HL05041E0	29

Part Number Index

Part Number	Page Number	Part Number	Page Number
HL05041V0	29	HZ05001V0	32
HL0504200	30	HZ05002E0	33
HL05042E0	30	HZ05002V0	33
HL05042V0	30	HZ05003E0	32
HL0504300	29	HZ05003V0	32
HL05043E0	29	HZ05011E0	32
HL05043V0	29	HZ05011V0	32
HL0505100	29	HZ05012E0	33
HL05051E0	29	HZ05012V0	33
HL05051V0	29	HZ05013E0	32
HL0505200	30	HZ05013V0	32
HL05052E0	30	HZ05021E0	32
HL05052V0	30	HZ05021V0	32
HL0505300	29	HZ05022E0	33
HL05053E0	29	HZ05022V0	33
HL05053V0	29	HZ05023E0	32
HL0506100	29	HZ05023V0	32
HL05061E0	29	HZ05031E0	32
HL05061V0	29	HZ05031V0	32
HL05062E0	30	HZ05032E0	33
HL05062V0	30	HZ05032V0	33
HL0506300	29	HZ05033E0	32
HL05063E0	29	HZ05033V0	32
HL05063V0	29	HZ05041E0	32
HL0507100	29	HZ05041V0	32
HL05071E0	29	HZ05042E0	33
HL05071V0	29	HZ05042V0	33
HL05072E0	30	HZ05043E0	32
HL05072V0	30	HZ05043V0	32
HL0507300	29	HZ05051E0	32
HL05073E0	29	HZ05051V0	32
HL05073V0	29	HZ05052E0	33
HL0509100	29	HZ05052V0	33
HL05091E0	29	HZ05053E0	32
HL05091V0	29	HZ05053V0	32
HL05092E0	30	HZ05061E0	32
HL05092V0	30	HZ05061V0	32
HL0509300	29	HZ05062E0	33
HL05093E0	29	HZ05062V0	33
HL05093V0	29	HZ05063E0	32
HL2T15	122	HZ05063V0	32
HL2T16	123	HZ05071E0	32
HL3T20	122	HZ05071V0	32
HL3T21	123	HZ05072E0	33
HP3PB37F	63	HZ05072V0	33
HP3SB37M	63	HZ05073E0	32
HZ05001E0	32	HZ05073V0	32

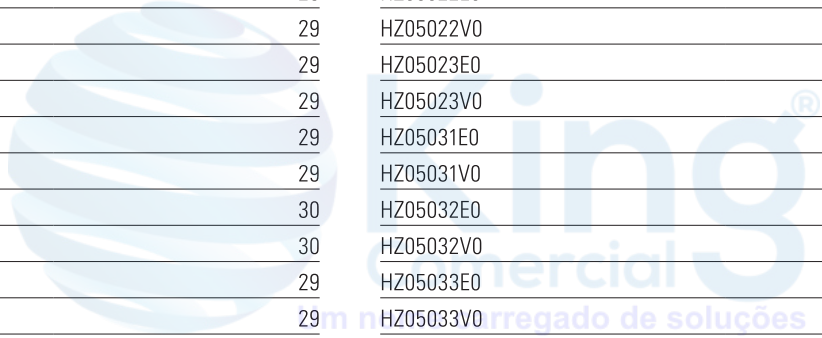

Part Number Index

Part Number	Page Number	Part Number	Page Number
HZ05091E0	32	LL12K41BS	16
HZ05091V0	32	LL12K46	16
HZ05092E0	33	LL12K46BS	16
HZ05092V0	33	LL12S46	123
HZ05093E0	32	LL12S46BS	123
HZ05093V0	32	LL12T46	123
HZ05201E0	32	LL12T46BS	123
HZ05201V0	32	LL16S51	123
HZ05202E0	33	LL16S51BS	123
HZ05202V0	33	LL16T50	122
HZ05211E0	32	LL1H11	15
HZ05211V0	32	LL1H4	15
HZ05212E0	33	LL1K11	16
HZ05212V0	33	LL1K4	16
HZ05221E0	32	LL1S10	122
HZ05221V0	32	LL1S11	123
HZ05222E0	33	LL1S11BS	123
HZ05222V0	33	LL1S12	123
HZ05231E0	32	LL1S17	123
HZ05231V0	32	LL1T10	122
HZ05232E0	33	LL1T11	123
HZ05232V0	33	LL1T11BS	123
HZ05241E0	32	LL1T12	124
HZ05241V0	32	LL1T17	124
HZ05242E0	33	LL20H51	15
HZ05242V0	33	LL20H51BS	15
HZ05251E0	32	LL20H56	15
HZ05251V0	32	LL20H56BS	15
HZ05252E0	33	LL20H61	15
HZ05252V0	33	LL20H61BS	15
LL10	70, 78, 88	LL20K51	16
LL1000	71	LL20K51BS	16
LL10H41	15	LL20K56	16
LL10H41BS	15	LL20K56BS	16
LL10K41	16	LL20K61	16
LL10K41BS	16	LL20K61BS	16
LL10S41	123	LL2H16	15
LL10T40	122	LL2H16BS	15
LL10T41	123	LL2H6	15
LL10T41BS	123	LL2K16	16
LL11	70, 78, 89	LL2K16BS	16
LL1100	71	LL2K6	16
LL12H41	15	LL2S15	122
LL12H41BS	15	LL2S16	123
LL12H46	15	LL2S16BS	123
LL12H46BS	15	LL2S17	124
LL12K41	16	LL2T15	122

Part Number Index

Part Number	Page Number	Part Number	Page Number
LL2T15BS	122	LL6T30BS	122
LL2T16	123	LL6T31	123
LL2T16BS	123	LL6T31BS	123
LL2T17	124	LL6T32	124
LL3H21	15	LL8HP16	15
LL3H21BS	15	LL8HP36	15
LL3H8	15	LL8HP36BS	15
LL3K21	16	LL8KP16	16
LL3K21BS	16	LL8KP36	16
LL3K8	16	LL8KP36BS	16
LL3S20	122	LL8S36	123
LL3S20BS	122	LL8S36BS	123
LL3S21	123	LL8S37	124
LL3S21BS	123	LL8T35	122
LL3S22	124	LL8T36	123
LL3T20	122	LL8T36BS	123
LL3T20BS	122	LNFT200	126
LL3T21	123	LNFT300	126
LL3T21BS	123	LNFT500	126
LL3T22	124	ML10FFP37	40
LL4HP10	15	ML10FFP37143	40
LL4HP26	15	ML10FFP37192	40
LL4HP26BS	15	ML10FFP37BS	40
LL4KP10	16	ML10FFP37BS143	40
LL4KP26	16	ML10FFP37BS192	40
LL4KP26BS	16	ML10FFP50BS	40
LL4S25	122	ML10FFP50BS143	40
LL4S25BS	122	ML10FFP50BS192	40
LL4S26	123	ML10FFS37	40
LL4S26BS	123	ML10FFS37143	40
LL4S27	124	ML10FFS37192	40
LL4T25	122	ML10FFS37BS	40
LL4T25BS	122	ML10FFS37BS143	40
LL4T26	123	ML10FFS37BS192	40
LL4T26BS	123	ML10FFS50BS	40
LL4T27	124	ML10FFS50BS143	40
LL6HP12	15	ML10FFS50BS192	40
LL6HP31	15	ML12FFP50	40
LL6HP31BS	15	ML12FFP50143	40
LL6KP12	16	ML12FFP50192	40
LL6KP31	16	ML12FFP50BS	40
LL6KP31BS	16	ML12FFP50BS143	40
LL6S30	122	ML12FFP50BS192	40
LL6S31	123	ML12FFP75BS	40
LL6S31BS	123	ML12FFP75BS143	40
LL6S32	124	ML12FFP75BS192	40
LL6T30	122	ML12FFS50	40

Part Number Index

Part Number	Page Number	Part Number	Page Number
ML12FFS50143	40	ML25FFP100BS143	40
ML12FFS50192	40	ML25FFP100BS192	40
ML12FFS50BS	40	ML25FFP125	40
ML12FFS50BS143	40	ML25FFP125143	40
ML12FFS50BS192	40	ML25FFP125192	40
ML12FFS75BS	40	ML40FFP150	40
ML12FFS75BS143	40	ML40FFP150143	40
ML12FFS75BS192	40	ML40FFP150BS	40
ML16FFP75	40	ML50FFP200143	40
ML16FFP75143	40	ML50FFS200143	40
ML16FFP75192	40	ML25FFS100BS	40
ML16FFP75BS	40	ML25FFS100BS143	40
ML16FFP75BS143	40	ML25FFS100BS192	40
ML16FFP75BS192	40	ML25FFS125	40
ML16FFS75	40	ML25FFS125143	40
ML16FFS75143	40	ML25FFS125192	40
ML16FFS75192	40	ML40FFS150	40
ML16FFS75BS	40	ML40FFS150143	40
ML16FFS75BS143	40	ML40FFS150BS	40
ML16FFS75BS192	40	ML2DBP25F	48
ML19FFP100	40	ML2DBP25F242	48
ML19FFP100143	40	ML2DBP25F292	48
ML19FFP100192	40	ML2DBP25F503	48
ML19FFP100BS	40	ML2DBP25FBS	48
ML19FFP100BS143	40	ML2DBP25FBS242	48
ML19FFP100BS192	40	ML2DBP25FBS292	48
ML19FFP75	40	ML2DBP25FBS503	48
ML19FFP75143	40	ML2DBS25F	48
ML19FFP75192	40	ML2DBS25F242	48
ML19FFP75BS	40	ML2DBS25F292	48
ML19FFP75BS143	40	ML2DBS25F503	48
ML19FFP75BS192	40	ML2DBS25FBS	48
ML19FFS100	40	ML2DBS25FBS242	48
ML19FFS100143	40	ML2DBS25FBS292	48
ML19FFS100192	40	ML2DBS25FBS503	48
ML19FFS100BS	40	ML2DBS93	48
ML19FFS100BS143	40	ML2H16	15
ML19FFS100BS192	40	ML2H16BS	15
ML19FFS75	40	ML2K16	16
ML19FFS75143	40	ML2K16BS	16
ML19FFS75192	40	ML3H21	15
ML19FFS75BS	40	ML3H21BS	15
ML19FFS75BS143	40	ML3K21	16
ML19FFS75BS192	40	ML3K21BS	16
ML1H11	15	ML4DBP50F	48
ML1K11	16	ML4DBP50F242	48
ML25FFP100BS	40	ML4DBP50F292	48

Part Number Index

Part Number	Page Number	Part Number	Page Number
ML4DBP50F503	48	ML6HP31	15
ML4DBP50FBS	48	ML6HP31BS	15
ML4DBP50FBS242	48	ML6KP31	16
ML4DBP50FBS292	48	ML6KP31BS	16
ML4DBP50FBS503	48	ML8DBP100F	48
ML4DBS50F	48	ML8DBP100F242	48
ML4DBS50F242	48	ML8DBP100F292	48
ML4DBS50F292	48	ML8DBP100F503	48
ML4DBS50F503	48	ML8DBP100FBS	48
ML4DBS50FBS	48	ML8DBP100FBS242	48
ML4DBS50FBS242	48	ML8DBP100FBS292	48
ML4DBS50FBS292	48	ML8DBP100FBS503	48
ML4DBS50FBS503	48	ML8DBS100F	48
ML4DBS93	48	ML8DBS100F242	48
ML4HP26	15	ML8DBS100F292	48
ML4HP26BS	15	ML8DBS100F503	48
ML4KP26	16	ML8DBS100FBS	48
ML4KP26BS	16	ML8DBS100FBS242	48
ML6DBP75F	48	ML8DBS100FBS292	48
ML6DBP75F242	48	ML8DBS100FBS503	48
ML6DBP75F292	48	ML8DBS93	48
ML6DBP75F503	48	ML8HFR36	17
ML6DBP75FBS	48	ML8HP36	15
ML6DBP75FBS242	48	ML8HP36BS	15
ML6DBP75FBS292	48	ML8KFR36	17
ML6DBP75FBS503	48	ML8KP36	16
ML6DBS75F	48	ML8KP36BS	16
ML6DBS75F242	48	P430P25M	87
ML6DBS75F292	48	P430S25H	87
ML6DBS75F503	48	P740S37H	87
ML6DBS75FBS	48	PDC10FF	38
ML6DBS75FBS242	48	PDC12FF	38
ML6DBS75FBS292	48	PDC12HK	10, 13, 16
ML6DBS75FBS503	48	PDC16FF	38
ML6DBS93	48	PDC19FF	38
ML6FFP25	40	PDC1HK	10, 13, 16
ML6FFP25143	40	PDC20HK	10, 16
ML6FFP25192	40	PDC25FF	38
ML6FFP25BS	40	PDC2HK	10, 13, 16, 129
ML6FFP25BS143	40	PDC3000	87
ML6FFP25BS192	40	PDC3HK	10, 13, 16, 129
ML6FFS25	40	PDC4HK	10, 13, 16, 129
ML6FFS25143	40	PDC6FF	38
ML6FFS25192	40	PDC6HK	10, 13, 16, 129
ML6FFS25BS	40	PDC8HK	10, 13, 16
ML6FFS25BS143	40	PPDC1HK	10, 13, 16, 95, 100, 105
ML6FFS25BS192	40	PPDC2HK	10, 13, 16, 86, 105, 129

Part Number Index

Part Number	Page Number	Part Number	Page Number
PPDC3HK	10, 13, 16, 86, 129	SDC10FF	38
PPDC4HK	124, 129	SDC12FF	38
PPDC4HK(RD)	10, 13, 16	SDC12HK	10, 13, 16
PPDC6HK	124, 129	SDC16FF	38
PPDC6HK(RD)	10, 13, 16	SDC19FF	38
PPDC8HK	124	SDC1HK	10, 13, 16
PPDC8HK(RD)	10, 13, 16	SDC20HK	10, 13, 16
PSDC1HK	10, 13, 16, 86, 95, 100, 105, 124	SDC25FF	38
PSDC2HK	10, 13, 16, 86, 105, 124	SDC2HK	10, 13, 16
PSDC3HK	10, 13, 16, 124	SDC3000	86
PSDC4HK(RD)	10, 13, 16	SDC3HK	10, 13, 16
PSDC6HK(RD)	10, 13, 16	SDC4HK	10, 13, 16
PSDC8HK(RD)	10, 13, 16	SDC6FF	38
RA0421000	132	SDC6HK	10, 13, 16
RA0422000	132	SDC8HK	10, 13, 16
RA0423000	132	WA0601400	58
RA0424000	132	WA06014E0	58
RA0425000	132	WA06014V0	58
RA0429V0	132	WA0601700	58
RD700	99	WA06017E0	58
RD700SL	99	WA06017V0	58
RD701	99	WA0602400	58
RD702	99	WA06024E0	58
RD702SL	99	WA06024V0	58
RD703	99	WA0602700	58
RD703SL	99	WA06027E0	58
RD704	99	WA06027V0	58
RD704L	99	WA0603400	58
RD704LSL	99	WA06034E0	58
RD704SL	99	WA06034V0	58
RD705	99	WA0603700	58
RD705L	99	WA06037E0	58
RD705LSL	99	WA06037V0	58
RD705SL	99	WA0604400	58
RD706	100	WA06044E0	58
RD706P	100	WA06044V0	58
RD706SL	100	WA0604700	58
RD707	100	WA06047E0	58
RD707SL	100	WA06047V0	58
RD708	100	WA0605400	58
RD708P	100	WA06054E0	58
RD708SL	100	WA06054V0	58
RD70B3	100	WA0605700	58
RD70B3SL	100	WA06057E0	58
RD70B7	100	WA06057V0	58
RD70D7	100	WA0606400	58
RD70D9	100	WA06064E0	58

Part Number Index

Part Number	Page Number	Part Number	Page Number
WA06064V0	58	WA06264E0	58
WA0606700	58	WA06264V0	58
WA06067E0	58	WA0626700	58
WA06067V0	58	WA06267E0	58
WA0607400	58	WA06267V0	58
WA06074E0	58	WA0627400	58
WA06074V0	58	WA06274E0	58
WA0607700	58	WA06274V0	58
WA06077E0	58	WA0627700	58
WA06077V0	58	WA06277E0	58
WA0609400	58	WA06277V0	58
WA06094E0	58	WA0629400	58
WA06094V0	58	WA06294E0	58
WA0609700	58	WA06294V0	58
WA06097E0	58	WA0629700	58
WA06097V0	58	WA06297E0	58
WA0621400	58	WA06297V0	58
WA06214E0	58	WA0633400	58
WA06214V0	58	WA06334E0	58
WA0621700	58	WA06334V0	58
WA06217E0	58	WA0633700	58
WA06217V0	58	WA06337E0	58
WA0622400	58	WA06337V0	58
WA06224E0	58	WA0635400	58
WA06224V0	58	WA06354E0	58
WA0622700	58	WA06354V0	58
WA06227E0	58	WA0635700	58
WA06227V0	58	WA06357E0	58
WA0623400	58	WA06357V0	58
WA06234E0	58	WA5611400	64
WA06234V0	58	WA5611700	64
WA0623700	58	WA5612400	63, 64
WA06237E0	58	WA5612700	63, 64
WA06237V0	58	WA5651400	64
WA0624400	58	WA5651700	64
WA06244E0	58	WA5652400	64
WA06244V0	58	WA5652700	64
WA0624700	58	WD0611400	59, 62
WA06247E0	58	WD0611700	59, 62
WA06247V0	58	WD0612400	59, 62
WA0625400	58	WD0612700	59, 62
WA06254E0	58	WD0613400	59, 62
WA06254V0	58	WD0613700	59, 62
WA0625700	58	WD0614400	59, 62
WA06257E0	58	WD0614700	59, 62
WA06257V0	58	WD0615400	59, 62
WA0626400	58	WD0615700	59, 62

Part Number Index

Part Number	Page Number	Part Number	Page Number
WD0616400	59, 62	WV06234V0	61
WD0616700	59, 62	WV06237E0	61
WD0617400	59, 62	WV06237V0	61
WD0617700	59, 62	WV06244E0	61
WD0619400	59, 62	WV06244V0	61
WD0619700	59, 62	WV06247E0	61
WV06014E0	61	WV06247V0	61
WV06014V0	61	WV06254E0	61
WV06017E0	61	WV06254V0	61
WV06017V0	61	WV06257E0	61
WV06024E0	61	WV06257V0	61
WV06024V0	61	WV06264E0	61
WV06027E0	61	WV06264V0	61
WV06027V0	61	WV06267E0	61
WV06034E0	61	WV06267V0	61
WV06034V0	61	WV06274E0	61
WV06037E0	61	WV06274V0	61
WV06037V0	61	WV06277E0	61
WV06044E0	61	WV06277V0	61
WV06044V0	61	WV06294E0	61
WV06047E0	61	WV06294V0	61
WV06047V0	61	WV06297E0	61
WV06054E0	61	WV06297V0	61
WV06054V0	61		
WV06057E0	61		
WV06057V0	61		
WV06064E0	61		
WV06064V0	61		
WV06067E0	61		
WV06067V0	61		
WV06074E0	61		
WV06074V0	61		
WV06077E0	61		
WV06077V0	61		
WV06094E0	61		
WV06094V0	61		
WV06097E0	61		
WV06097V0	61		
WV06214E0	61		
WV06214V0	61		
WV06217E0	61		
WV06217V0	61		
WV06224E0	61		
WV06224V0	61		
WV06227E0	61		
WV06227V0	61		
WV06234E0	61		

Notes



Distribuidor Autorizado



☎ (19)3267-9611 - 3269-1432



KING.VENDAS@YAHOO.COM.BR

KINGVENDAS@KINGCOMERCIAL.COM.BR

King Comercial Ltda

Um nome carregado de soluções

Eaton
Hydraulics Group USA
14615 Lone Oak Road
Eden Prairie, MN 55344
USA
Tel: 952-937-9800
Fax: 952-294-7722
www.eaton.com/hydraulics

Eaton
Hydraulics Group Europe
Route de la Longeraie 7
1110 Morges
Switzerland
Tel: +41 (0) 21 811 4600
Fax: +41 (0) 21 811 4601

Eaton
Hydraulics Group Asia Pacific
Eaton Building
No.7 Lane 280 Linhong Road
Changning District,
Shanghai 200335
China
Tel: (+86 21) 5200 0099
Fax: (+86 21) 2230 7240